

**/001**    Collezioni Collections

**e DePadova**



**Square 16**  
-- 2004/2016



Square 16



**Square 16** Divano — Sofa / 2004-2016

**606 Universal Shelving System**

Libreria — Bookcase / 1984

**Chab-Table** Tavolino — Low table / Nendo 2005

pag. 2.3

**Square 16** Divano — Sofa / 2004-2016

pag. 4

**Collezioni** Collections





Square 16

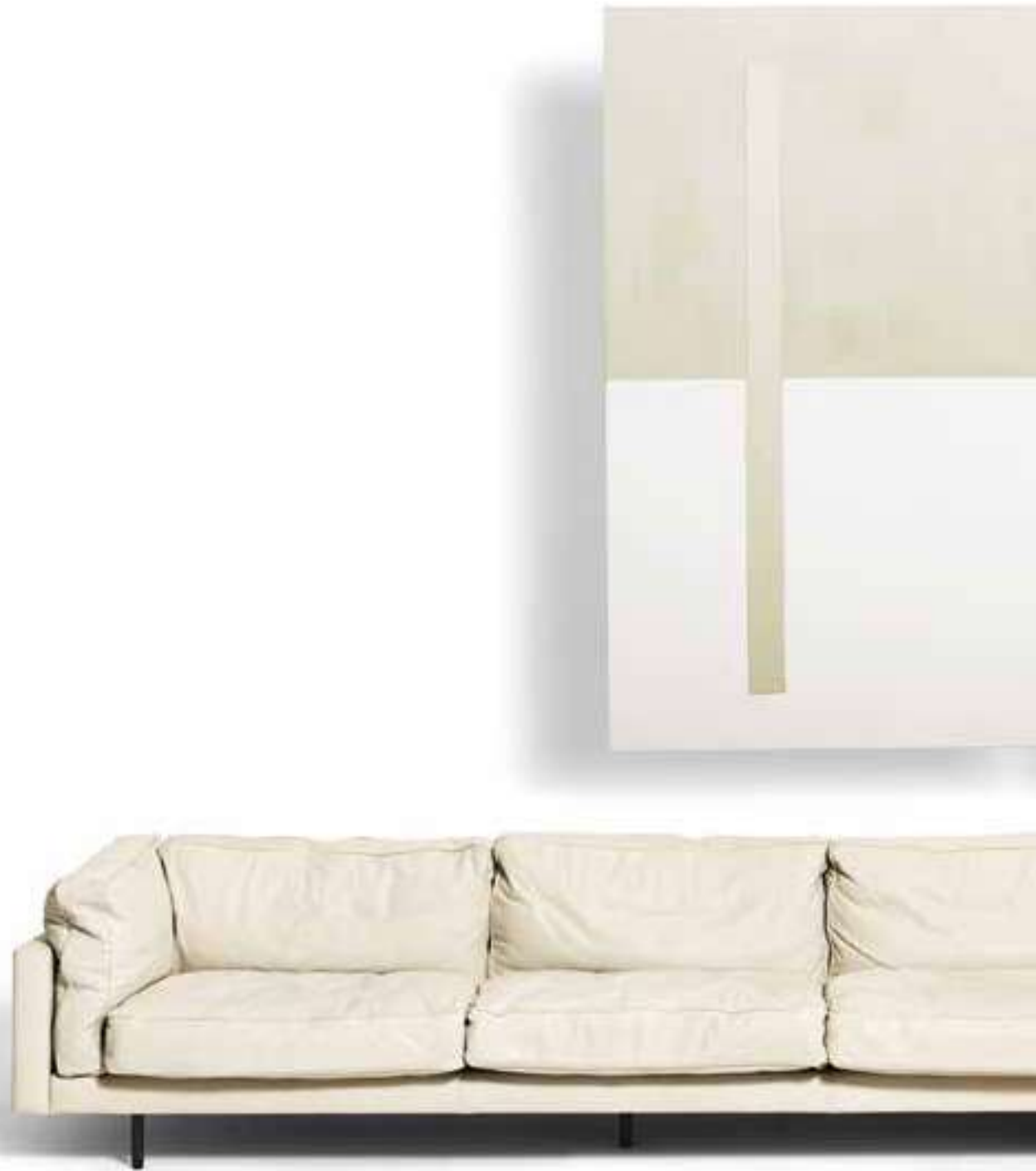

**Square 16** Divano componibile — Modular sofa  
/2004-2016

**Tetris** Tavolino — Low table / Nendo 2007  
pag. 6.7

**Square 16** Divano componibile — Modular sofa  
/2004-2016

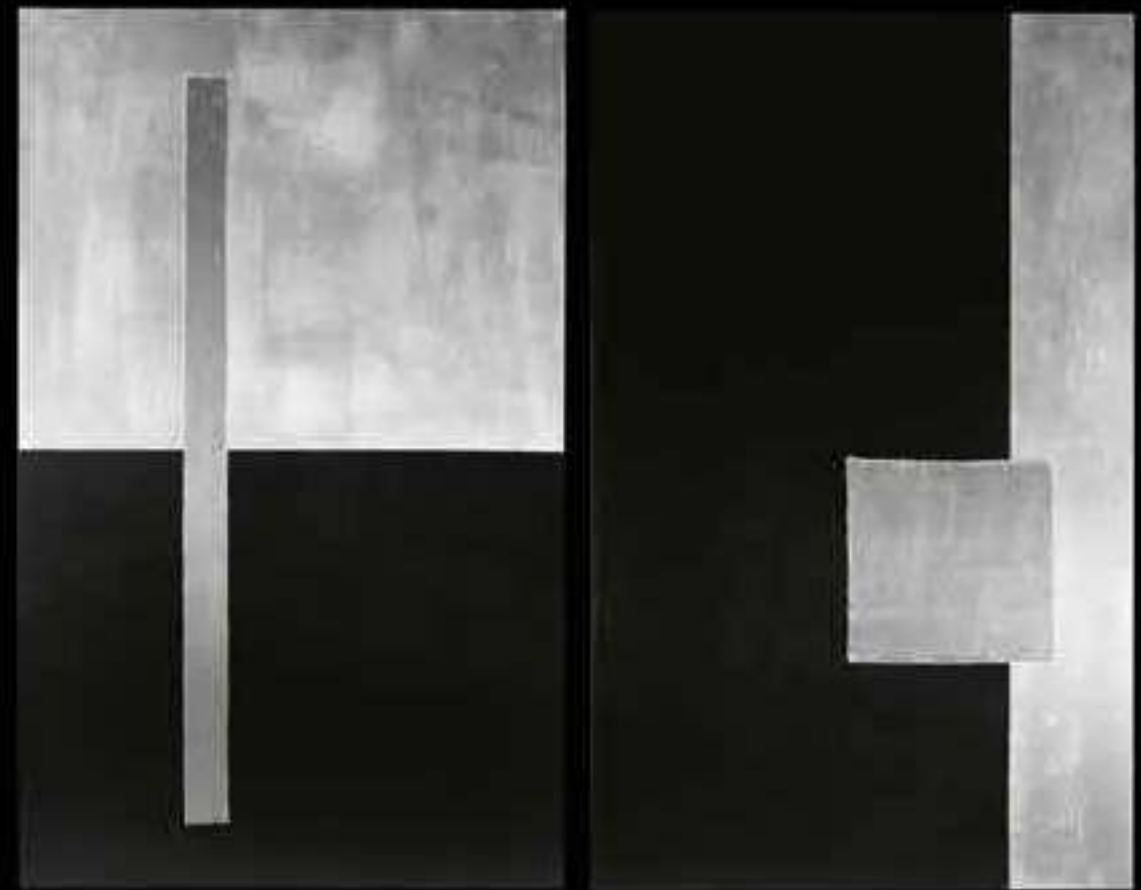



**Square 16** Divano componibile — Modular sofa  
/ 2004-2016  
**Sen** Tavolino — Low table / K. Oshiro 2016

**Square Ground**  
-- 2017







# Square Traditional

-- 2004



**Square Ground** Divano — Sofa / 2017  
**Sail** Tavolino — Low table / Nendo 2017  
**Sen** Tavolino — Low table / K. Oshiro 2016  
**Mate** Tavolino — Low table / A. Castiglioni 1992  
**Nota** Lampada — Lamp / E. Ossino 2017  
**Margherita** Poltrona — Armchair / P. Lissoni 2017  
pag. 14.15

**Square Traditional** Divano — Sofa / 2004  
**Sen** Tavolino — Low table / K. Oshiro 2016  
**Margherita** Poltrona — Armchair / P. Lissoni 2017  
**Twig** Lampada — Lamp / K. Takeuchi 2017  
**C.O.P.** Contenitore — Storage  
/ M. Harrsen 2012 MA/U Studio  
pag. 16.17

**Margherita** Poltrona — Armchair / P. Lissoni 2017  
**C.O.P.** Contenitori — Storage  
/ M. Harrsen 2012 MA/U Studio  
pag. 19







**Margherita** Poltrona — Armchair / P. Lissoni 2017

Twig

Twig Lampada—Lamp/K. Takeuchi 2017

22 23



# Square Lounge

-- 2019

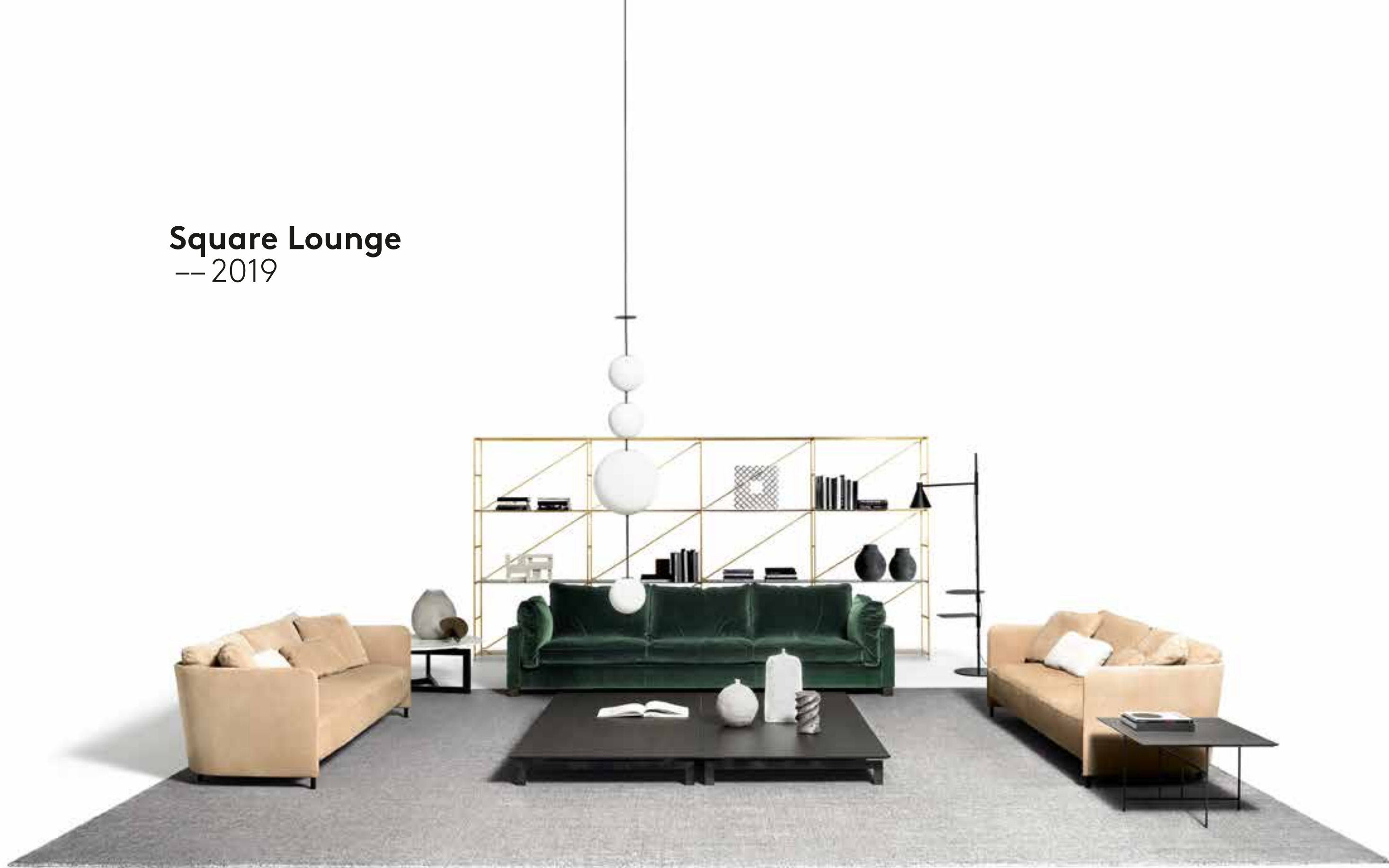

## Square Lounge



**Square Lounge** Divano -- Sofa / C.R.S. De Padova 2019  
**Blendy Lounge** Divano -- Sofa / O. Tahara 2019  
**Connecticut** Tavolino -- Low table / J. Risom 1965 -- *Edizioni De Padova*  
**Flying Landscape** Tavolino -- Low table / P. Lissoni 2019  
**Elementi** Lampada a sospensione -- Suspension lamp / E. Ossino 2018  
**Nota** Lampada -- Lamp / E. Ossino 2017  
**Sen** Tavolino -- Low table / K. Oshiro 2018  
**Madison** Tappeto -- Rug / 2018  
**R.I.G. Modules** Libreria -- Bookcase / M. Harrsen 2012-2019 MA/U Studio  
pag. 24.25

**Square Lounge** Divano -- Sofa / C.R.S. De Padova 2019  
**Nota** Lampada -- Lamp / E. Ossino 2017  
**R.I.G. Modules** Libreria -- Bookcase / M. Harrsen 2012-2019 MA/U Studio  
pag. 28.29

Square Lounge

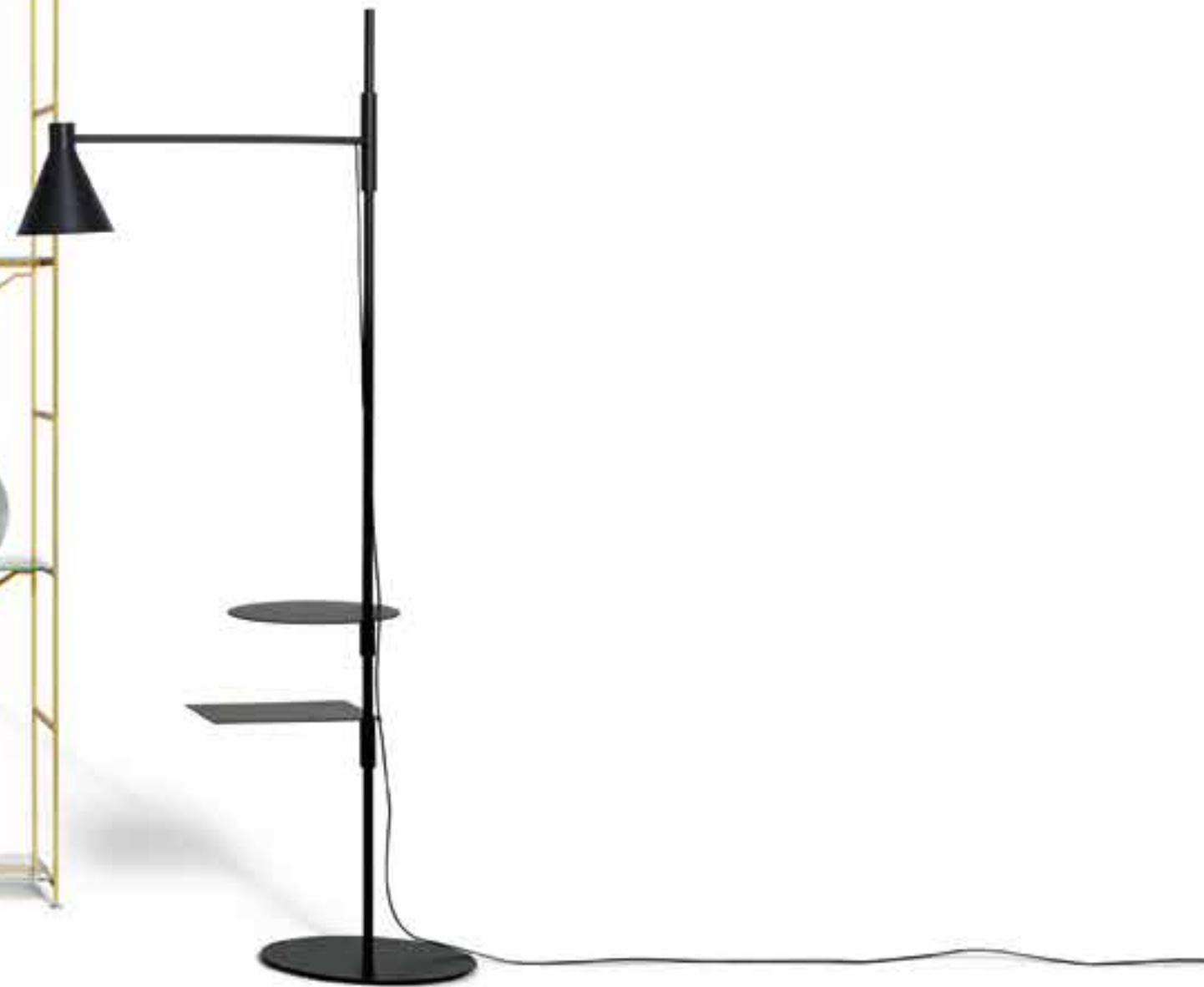



Square Lounge



Square Lounge Divano — Sofa / C.R.S. De Padova 2019



**Blendy Lounge** Divano — Sofa/O. Tahara 2019



**Raffles**  
**Vico Magistretti**  
— 1988



Raffles



**Raffles** Divano — Sofa / V. Magistretti 1988  
**Chab-Table** Tavolino — Low table / Nendo 2005  
pag.34.35





**Raffles** Poltrona-pouf -- Armchair-pouf  
/V. Magistretti 1988  
pag.39

# Mosaïque Piero Lissoni -- 2017

**Mosaïque** Divano componibile -- Modular sofa  
/ P. Lissoni 2017-2018  
**Swiss 17** Tavolino -- Low table  
/ M. Zocca 2003-2017  
**Sen** Tavolino -- Small table / K. Oshiro 2016  
**Twig** Lampada -- Lamp / K. Takeuchi 2017  
pag. 42.43

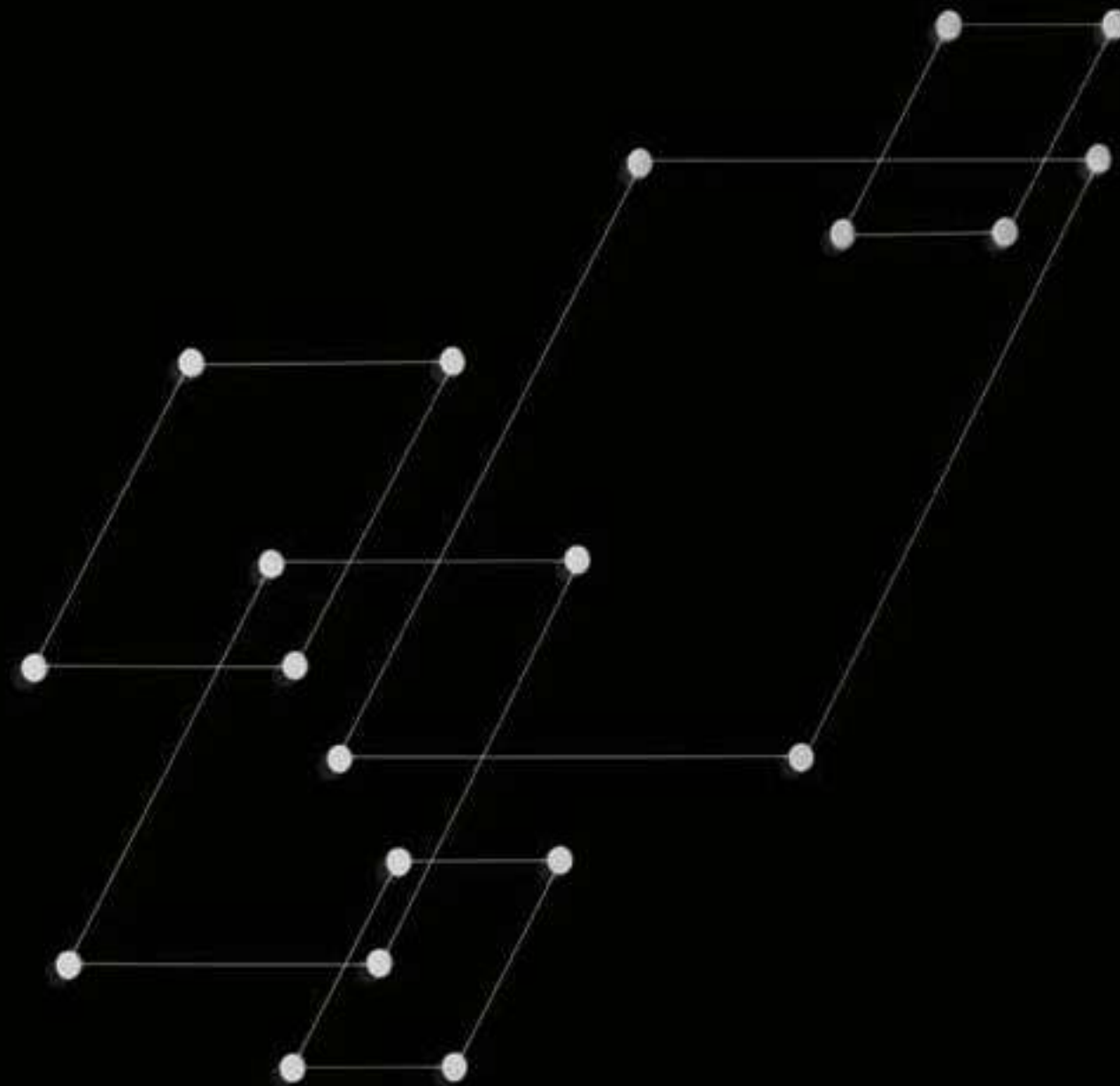





**Swiss 17** Tavolino — Low table  
/M. Zocca 2003-2017

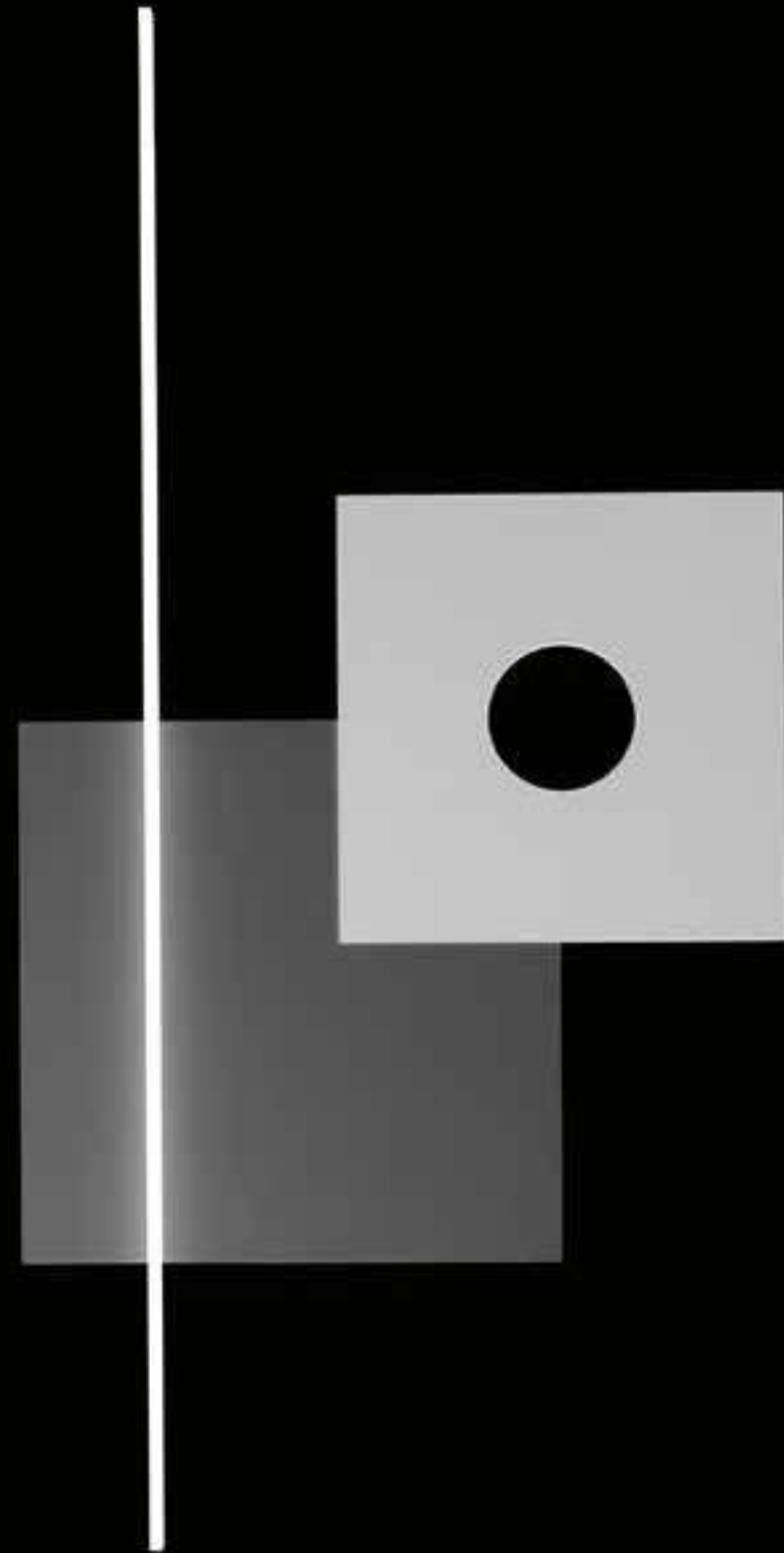

Swiss 17







**Mosaïque** Divano componibile — Modular sofa  
/P. Lissoni 2017-2018  
**Nota** Lampada — Lamp /E. Ossino 2017  
**Sen** Tavolino — Low table /K. Oshiro 2016

Nota

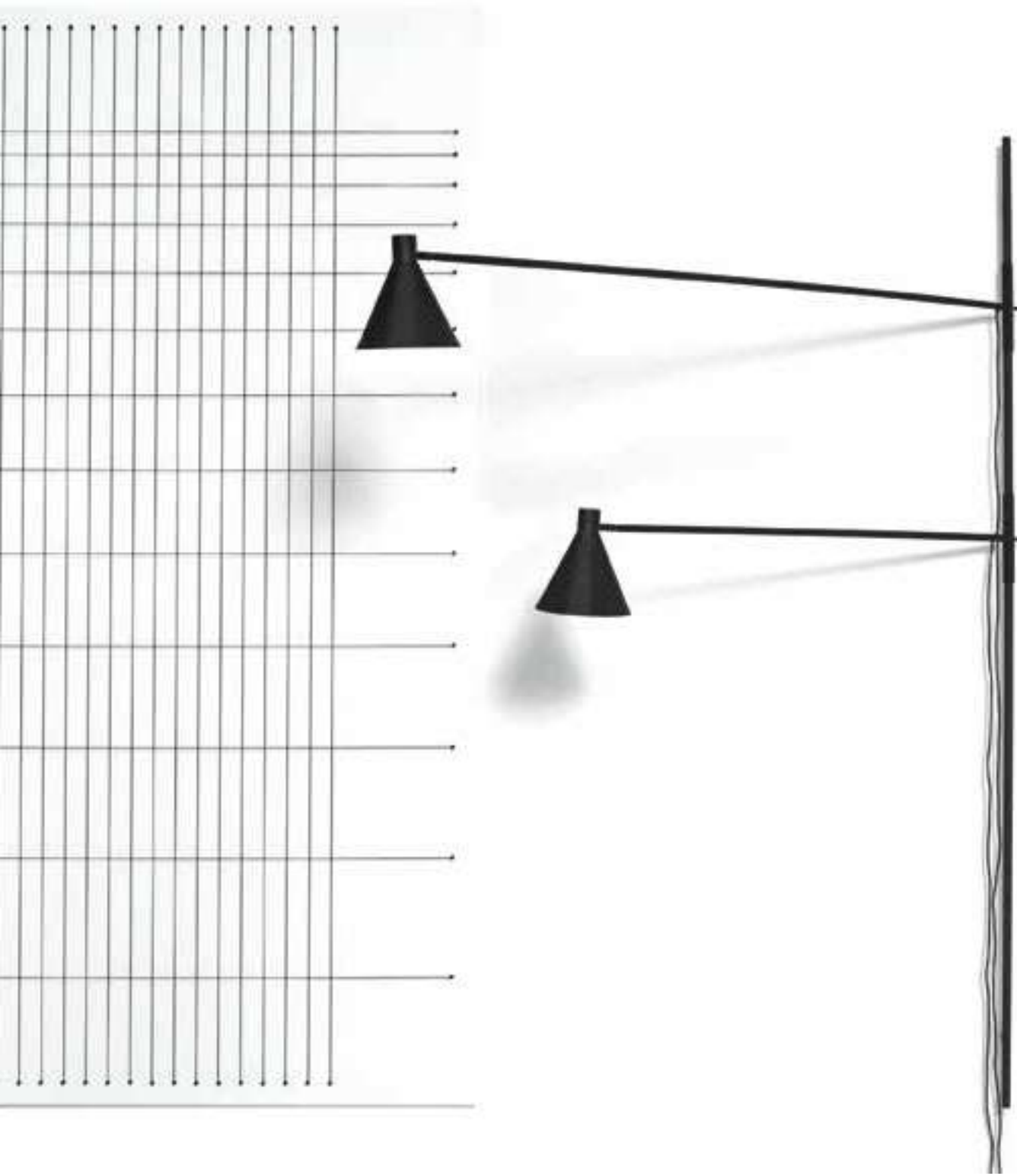

**Nota** Lampada -- Lamp/E. Ossino 2017  
pag. 50

**Mosaïque** Divano componibile -- Modular sofa/P. Lissoni 2017-2018

**Collezioni** Collections



**Mosaïque** Divano componibile -- Modular sofa / P. Lissoni 2017-2018  
**Mosaïque** Pouf / P. Lissoni 2017-2018  
**Sail** Tavolino -- Low table / Nendo 2017  
**Cielo-Terra** Lampada -- Lamp / Studiocharlie 2017



**Mosaïque** Pouf / P. Lissoni 2017-2018  
**Cielo-Terra** Lampada -- Lamp / Studiocharlie 2017





## Mosaïque



**Mosaïque** Divano componibile — Modular sofa/P. Lissoni 2017-2018

**Sen** Tavolino — Low table/K. Oshiro 2016-2018

**Elementi** Lampada da tavolo — Table lamp/E. Ossino 2018

**Madison** Tappeto — Rug/2018

**R.I.G. Modules** Libreria — Bookcase/M. Harrsen 2012 MA/U Studio  
pag. 56.57

**Elementi** Lampade — Lamps/E. Ossino 2018  
pag. 58

**Mosaïque** Divano componibile — Modular sofa/P. Lissoni 2017-2018

**Collezioni** Collections



Sen Tavolino -- Low table / K. Oshiro 2016-2018





**Betulla** Tavolino — Low table  
/V. Magistretti 1994-2016





**Mosaïque** Divano componibile — Modular sofa  
/P. Lissoni 2017-2018

**Swiss 17** Tavolino — Low table/M. Zocca  
2003-2017

**Cielo-Terra** Lampada — Lamp  
/Studiocharlie 2017

**R.I.G. Modules** Libreria — Bookcase  
/M. Harrsen 2012 MA/U Studio  
pag. 64.65

**Mosaïque** Divano componibile — Modular sofa  
/P. Lissoni 2017-2018

**Swiss 17** Tavolino — Low table/M. Zocca  
2003-2017

**Cielo-Terra** Lampada — Lamp  
/Studiocharlie 2017  
pag. 67





**Blendy**  
**Omi Tahara**  
-- 2018



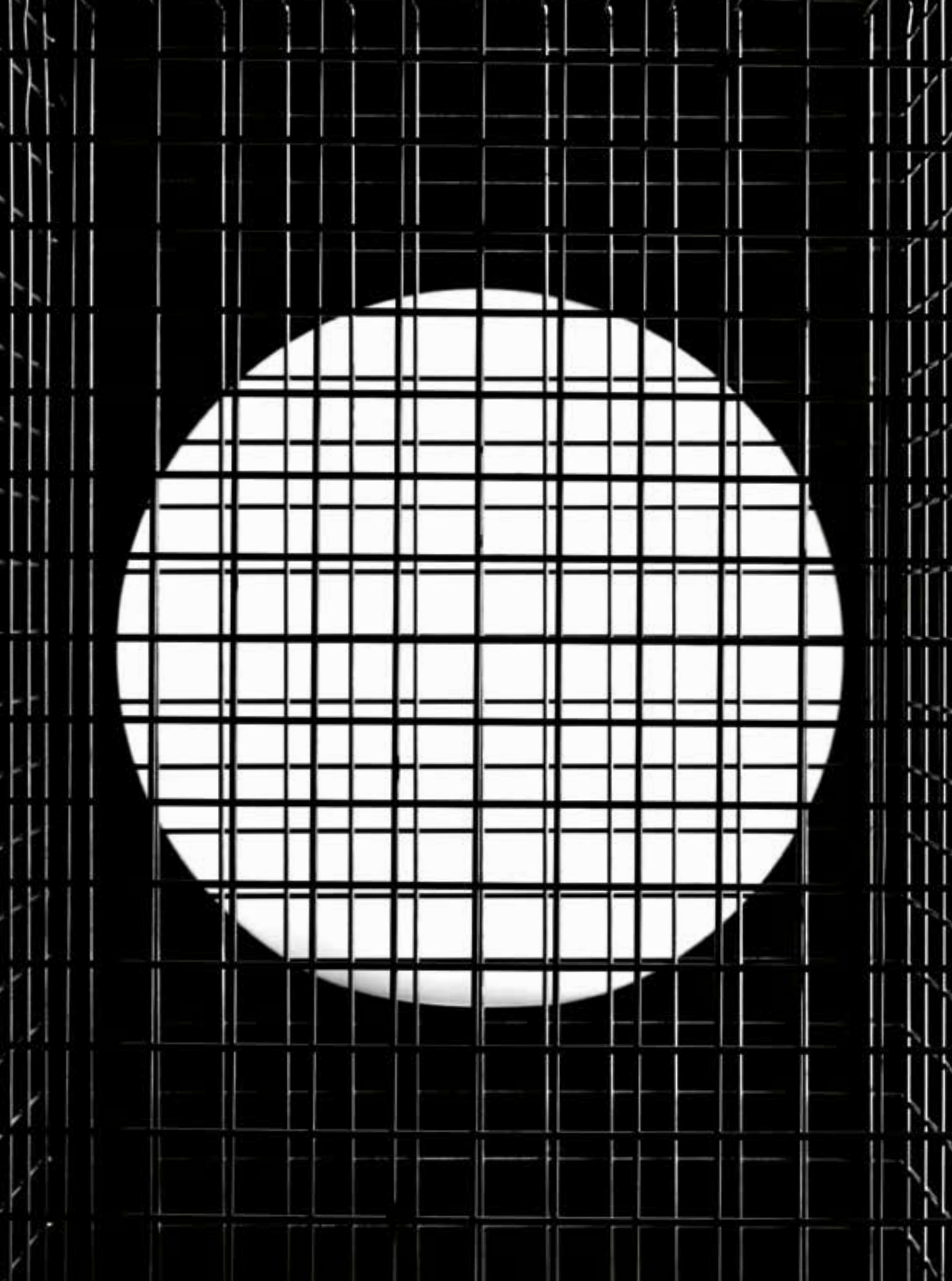

## Blendy

**Blendy** Divano — Sofa/O. Tahara 2018  
**Elementi** Lampada da tavolo — Table lamp  
/E. Ossino 2018  
**Sen** Tavolino — Low table/K. Oshiro 2016  
**Quadrato Espositore** Tavolino  
— Low table/1996-2018  
**T.54** Poltrona — Armchair/Fratelli Monti 1954  
Archivio storico Bonacina 1889 — *Edizioni De Padova*  
**Bamako** Tappeto — Rug  
**R.I.G. Modules** Libreria — Bookcase  
/M. Harrsen 2012 MA/U Studio  
pag. 68.69

**Blendy** Divano — Sofa/O. Tahara 2018

**Collezioni** Collections





Blendy Divano — Sofa/O. Tahara 2018







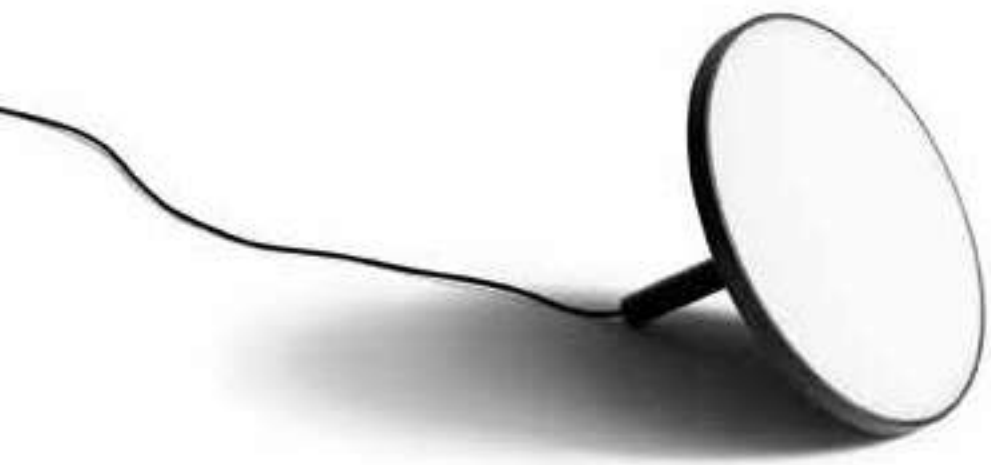

**Blendy** Divano -- Sofa / O. Tahara 2018  
**Blendy** Poltrona -- Armchair / O. Tahara 2018  
**Poet** Lampada da tavolo -- Table lamp  
/ K. Takeuchi 2018  
**Sen** Tavolino -- Low table / K. Oshiro 2016  
**R.I.G. Modules** Libreria -- Bookcase  
/ M. Harrsen 2012 MA/U Studio  
pag. 74.75  
**Poet** Lampada da tavolo -- Table lamp  
/ K. Takeuchi 2018





**Poet** Lampada a sospensione—Suspension lamp  
/K. Takeuchi 2018



Poet

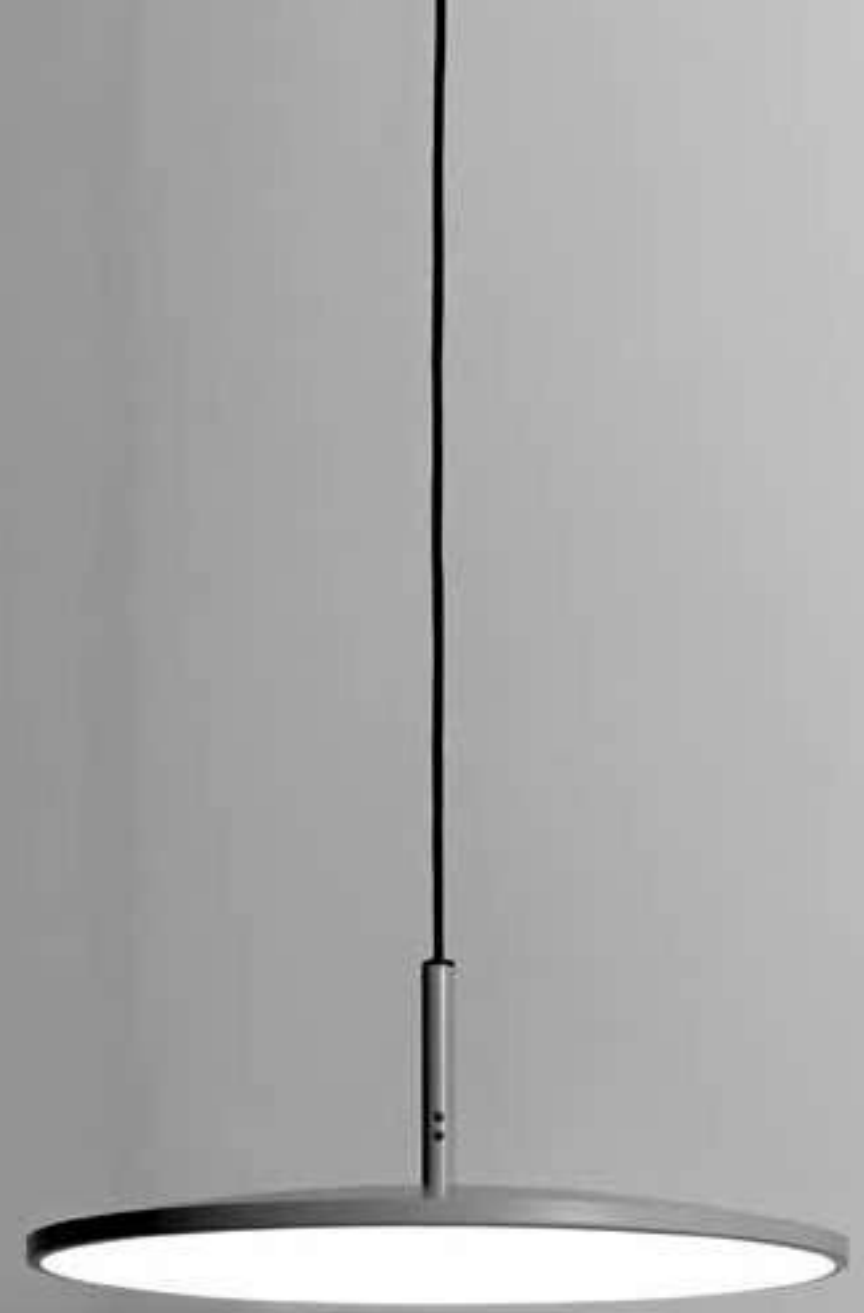

**Poet** Lampada a sospensione — Suspension lamp  
/K. Takeuchi 2019

Blendy



**Blendy** Poltrona — Armchair / O. Tahara 2018



**Blendy Lounge**  
**Omi Tahara**  
-- 2019





**Blendy Lounge** Divano — Sofa  
/O. Tahara 2019







**Blendy Lounge** Poltrona — Armchair  
/O. Tahara 2019

**Landscape**  
**Piero Lissoni**  
-- 2016





**Landscape** Divano — Sofa / P. Lissoni 2016  
**Chab-Table** Tavolino — Low table / Nendo 2005  
**SC16** Contenitore — Storage unit / 2016  
pag. 90.91  
**Landscape** Divano — Sofa / P. Lissoni 2016



**SC16** Contenitore -- Storage unit / 2016

**Landscape** Divano componibile -- Modular sofa  
/ P. Lissoni 2016

**Quadrato Espositore** Tavolino -- Low table / 1996-2018  
pag. 96.97





Landscape





**Flying Landscape**  
**Piero Lissoni**  
-- 2019



**Flying Landscape** Divano componibile — Modular sofa / P. Lissoni 2019  
**Flying Landscape** Tavolino — Low table / P. Lissoni 2019  
**Combi Cabinets** Contenitore — Cabinet / P. Lissoni 2019  
**Sen** Tavolino — Low table / K. Oshiro 2016  
**Sail** Tavolino — Low table / Nendo 2017  
**Elementi** Lampada a sospensione — Suspension lamp / E. Ossino 2018  
**Madison** Tappeto — Rug / 2018  
pag. 100.101

**Cilindri** Lampada — Lamp / E. Ossino 2019  
pag. 103





## Flying Landscape

**Flying Landscape** Divano componibile — Modular sofa / P. Lissoni 2019  
**Flying Landscape** Tavolino — Low table / P. Lissoni 2019  
**Sail** Tavolino — Low table / Nendo 2017  
**Elementi** Lampada a sospensione — Suspension lamp / E. Ossino 2018  
pag.104

**Flying Landscape** Divano componibile — Modular sofa / P. Lissoni 2019  
**Flying Landscape** Tavolino — Low table / P. Lissoni 2019  
**Combi Cabinets** Contenitore — Cabinet / P. Lissoni 2019  
**Sen** Tavolino — Low table / K. Oshiro 2016  
**Sail** Tavolino — Low table / Nendo 2017  
**Elementi** Lampada a sospensione — Suspension Lamp / E. Ossino 2018  
**Madison** Tappeto — Rug / 2018  
pag.106.107

**Collezioni** Collections



Flying Landscape



**Flying Landscape** Divano componibile — Modular sofa  
/ P. Lissoni 2019

**Collezioni** Collections



**Flying Landscape** Divano componibile—Modular sofa  
/P. Lissoni 2019  
**Flying Landscape** Tavolino—Low table  
/P. Lissoni 2019





**Metallaro** Tavolino — Low table  
/ Studiocharlie 2019



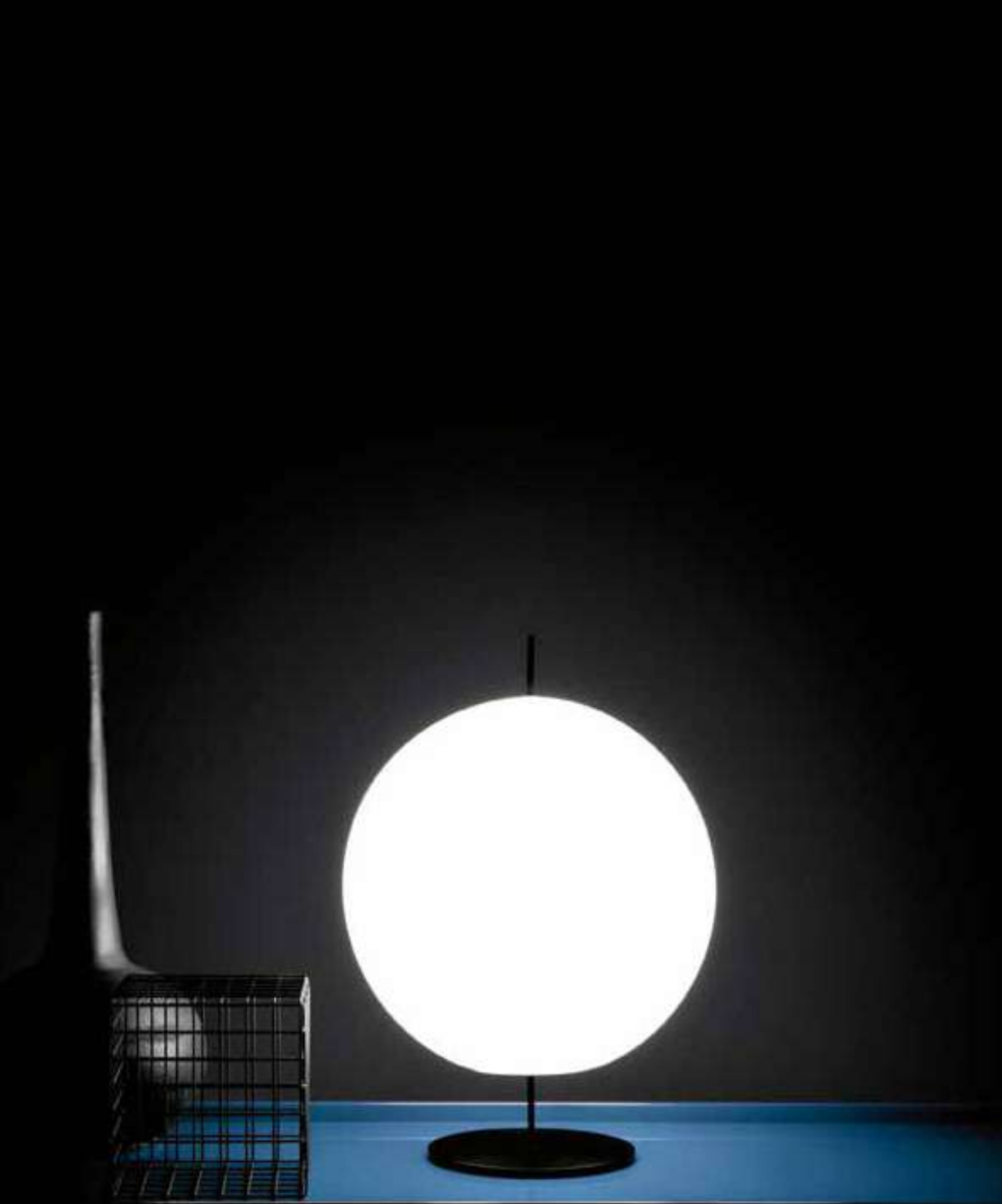

## Combi Cabinets

**Combi Cabinets** Contenitore -- Cabinet  
/ P. Lissoni 2019

**Nota** Lampada -- Lamp / E. Ossino 2017

**Wingback** Poltrona -- Armchair  
/ P. McCobb 1956 -- *Edizioni De Padova*

**Ottoman for Wingback** Pouf  
/ 1956 -- *Edizioni De Padova*

**Elementi** Lampada da tavolo -- Table lamp /  
E. Ossino 2018

**Bamako** Tappeto -- Rug /  
pag. 114.115

**Combi Cabinets** Contenitore -- Cabinet  
/ P. Lissoni 2019

**Elementi** Lampada da tavolo -- Table lamp /  
E. Ossino 2018  
pag. 116

**Combi Cabinets** Contenitore -- Cabinet  
/ P. Lissoni 2019



Wingback



**Wingback** Poltrona — Armchair  
/ P. McCobb 1956 — Edizioni De Padova  
**Ottoman for Wingback** Pouf  
/ 1956 — Edizioni De Padova





**Erei**  
**Elisa Ossino**  
— 2018







**Erei** Divano componibile—Modular Sofa/E. Ossino 2018  
**Erei** Tavolino—Low table/E. Ossino 2018  
**T.54** Poltrona—Armchair/Fratelli Monti 1954  
Archivio storico Bonacina 1889 — *Edizioni De Padova*  
**Sen** Tavolino—Low table/K. Oshiro 2016/2018  
**Elementi** Lampada da tavolo—Table lamp/E. Ossino 2018  
**Madison** Tappeto—Carpet/2018  
**R.I.G. Modules** Libreria—Bookcase/M. Harrsen 2012 MA/U Studio  
pag. 120.121  
**Erei** Divano componibile—Modular sofa/E. Ossino 2018



**T.54** Poltrona — Armchair / Fratelli Monti 1954  
Archivio storico Bonacina 1889 -- Edizioni De Padova





**T.54** Poltrona — Armchair / Fratelli Monti 1954  
Archivio storico Bonacina 1889 -- Edizioni De Padova





Erei

**Erei** Divano — Sofa / E. Ossino 2018  
**Erei** Tavolino — Low table / E. Ossino 2018  
**Elementi** Lampada da tavolo — Table lamp  
/ E. Ossino 2018  
**Madison** Tappeto — Rug / 2018  
pag. 128.129





**Erei** Pouf/E. Ossino 2018  
**Erei** Divano — Sofa/E. Ossino 2018







**Erei** Divano — Sofa/E. Ossino 2018  
**SC16** Contenitore — Storage unit/2016  
**Sen** Tavolino — Low table/K. Oshiro 2016  
**Nota** Lampada — Lamp/E. Ossino 2017  
**Silvia** Poltrona — Armchair/P. Tilche 1960  
Archivio storico Bonacina 1889 — *Edizioni De Padova*  
**Bamako** Tappeto — Rug



**Erei** Divano — Sofa / E. Ossino 2018  
**Erei** Tasca per bracciolo-schienale — Leather  
armrest-back pocket / E. Ossino 2019

Erei daybed



Erei daybed / E. Ossino 2019







**Silvia** Poltrona — Armchair / P. Tilche 1960  
Archivio storico Bonacina 1889 -- Edizioni De Padova



Étiquette  
GamFratesi  
— 2018

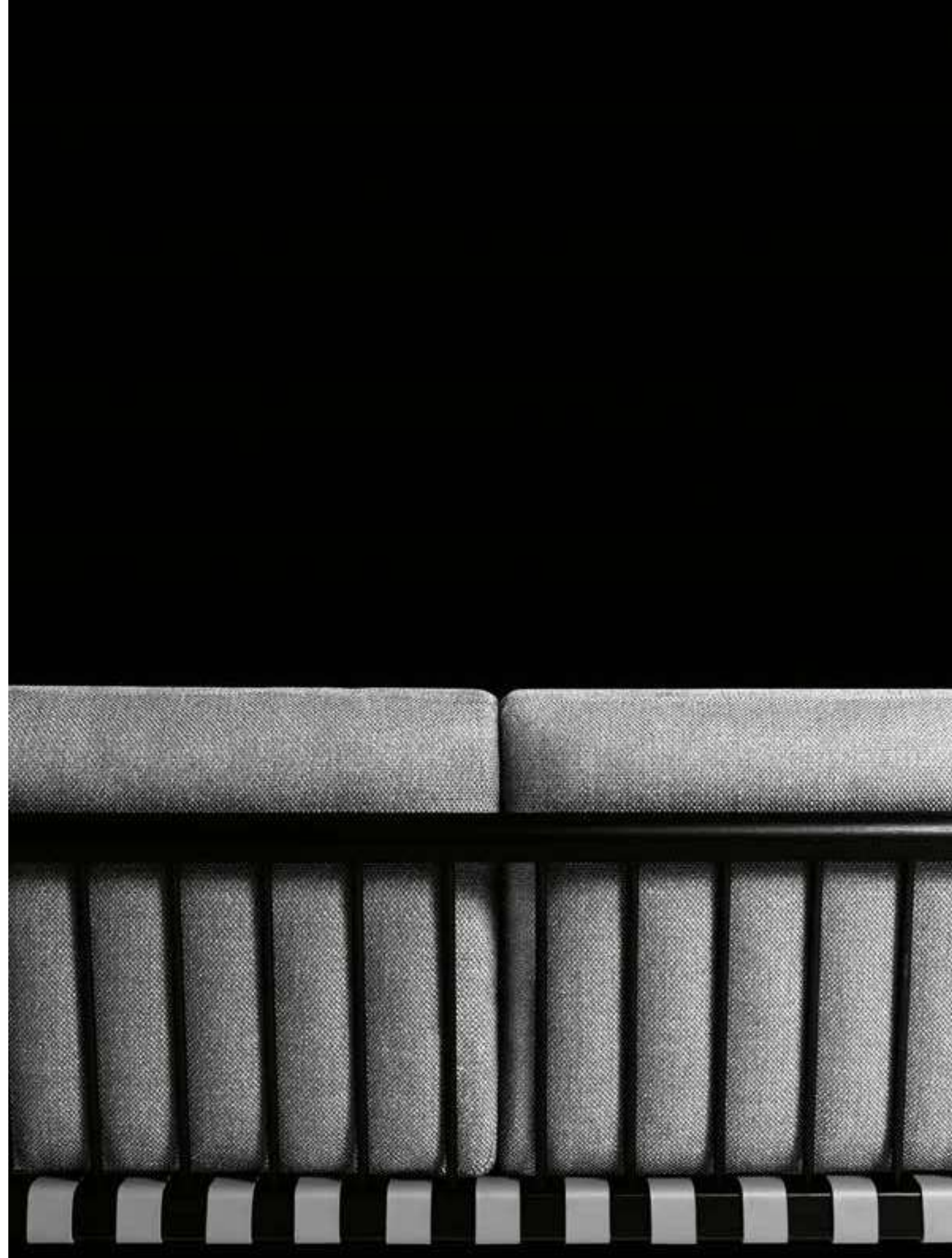









**Étiquette** Divano -- Sofa / GamFratesi 2018  
**Chesto** Poltrona -- Armchair / P. Norguet 2018  
**Erei** Tavolino -- Low table / E. Ossino 2018  
**Sail** Tavolino -- Low table / Nendo 2017  
**Nota** Lampada -- Lamp / E. Ossino 2017  
**Madison** Tappeto -- Rug / 2018  
**R.I.G. Modules** Libreria -- Bookcase  
/ M. Harrsen 2012 MA/U Studio  
pag. 144.145

**Étiquette** Divano -- Sofa / GamFratesi 2018



**Chesto** Poltrona — Armchair  
/ P. Norguet 2018



Sail



**Sail** Tavolino — Low table / Nendo 2017

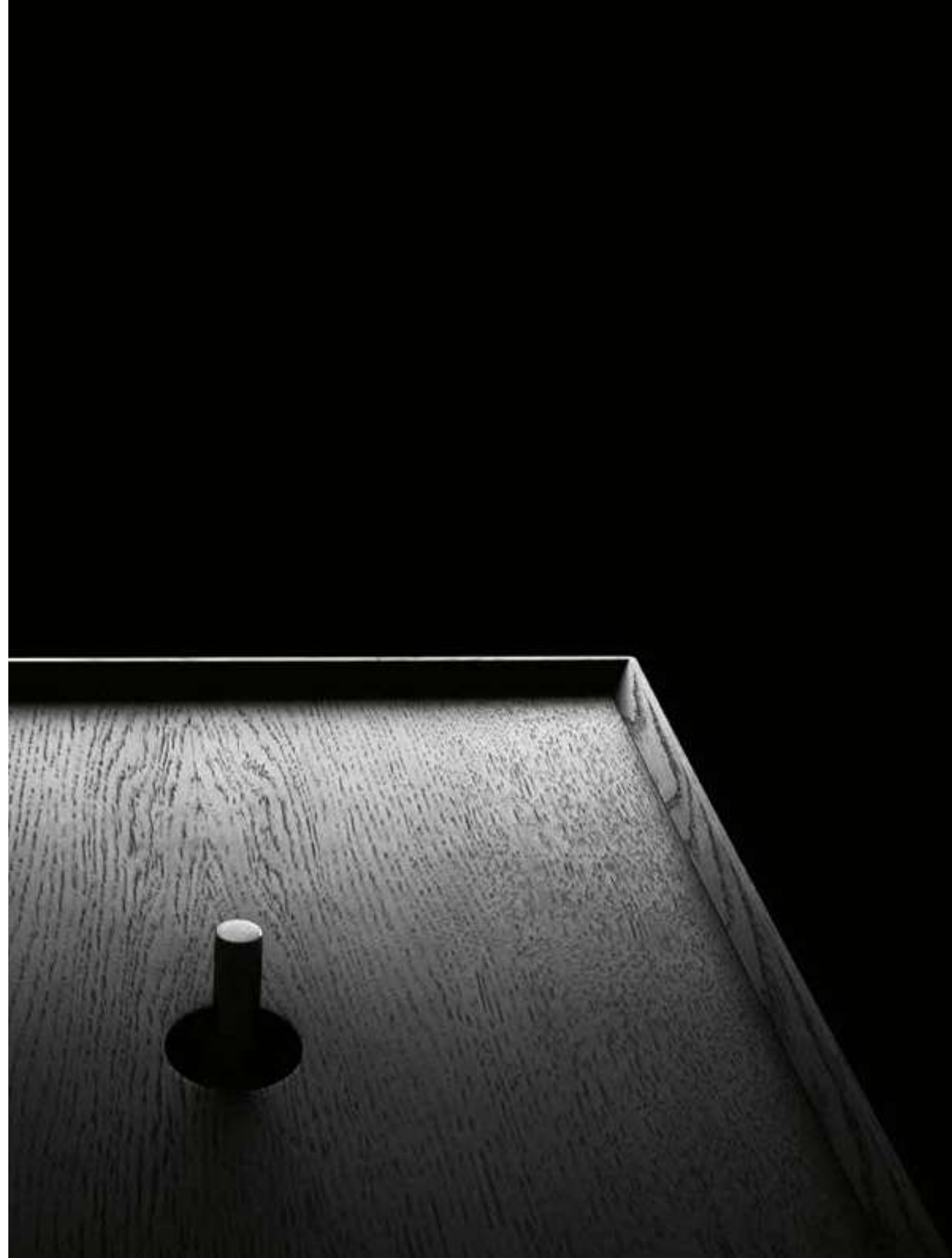

Étiquette  
GamFratesi  
— 2019



**Étiquette** Divano componibile -- Modular sofa / GamFratesi 2019  
**Étiquette** Pouf / GamFratesi 2018  
**Cilindri** Lampada da tavolo -- Table lamp / E. Ossino 2019  
**Flying Landscape** Tavolino -- Low table / P. Lissoni 2019  
**Elementi** Lampada a sospensione -- Suspension lamp / E. Ossino 2019  
**Wingback** Poltrona -- Armchair / P. McCobb 1956 -- *Edizioni De Padova*  
**Ottoman for Wingback** Pouf / 1956 -- *Edizioni De Padova*  
**Bamako** Tappeto -- Rug  
pag.152.153

**Étiquette** Divano componibile -- Modular sofa / GamFratesi 2019  
**Flying Landscape** Tavolino -- Low table / P. Lissoni 2019  
**Elementi** Lampada a sospensione -- Suspension lamp / E. Ossino 2019  
**Bamako** Tappeto -- Rug







**Flying Landscape** Tavolino -- Low table  
/P. Lissoni 2019

Étiquette



Étiquette Divano componibile — Modular sofa  
/GamFratesi 2019







**Étiquette** Poltrona — Armchair  
/GamFratesi 2019







## Étiquette



Étiquette Pouf / GamFratesi 2018



**Yak**  
**LucidiPevere**  
-- 2015

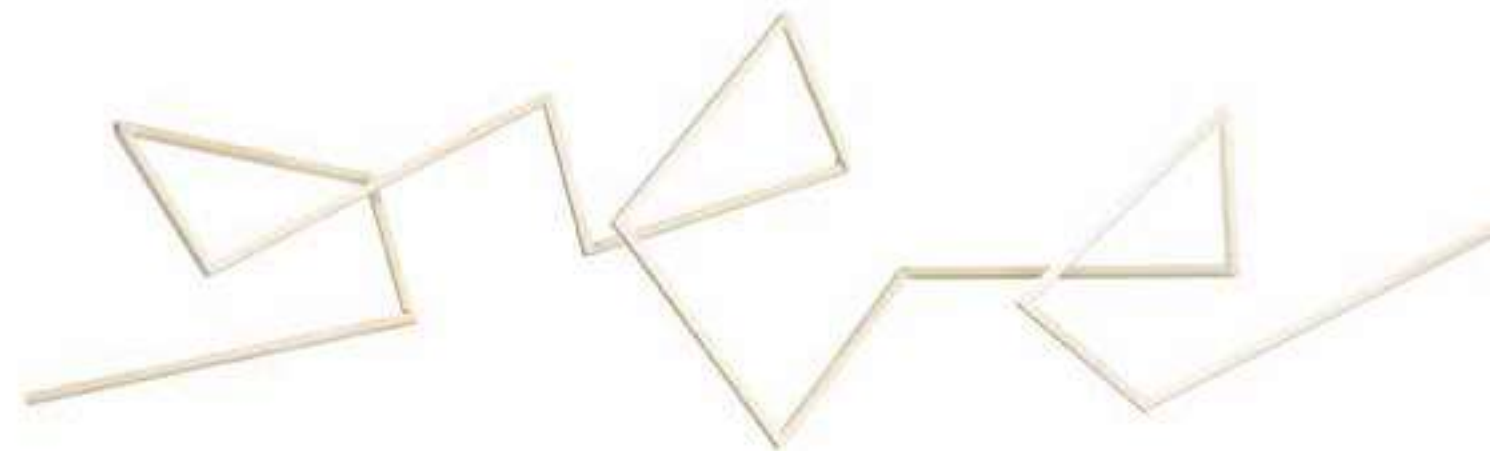



## Basket



**Yak** Divano -- Sofa / LucidiPevere 2015  
**Basket** Poltrona -- Armchair  
/V. Magistretti 2004  
**Tynn** Tappeto -- Rug  
pag. 168.169

**Basket** Poltrona -- Armchair  
/V. Magistretti 2004

**Collezioni** Collections

Yak



**Yak** Poltrona — Armchair / LucidiPevere 2015

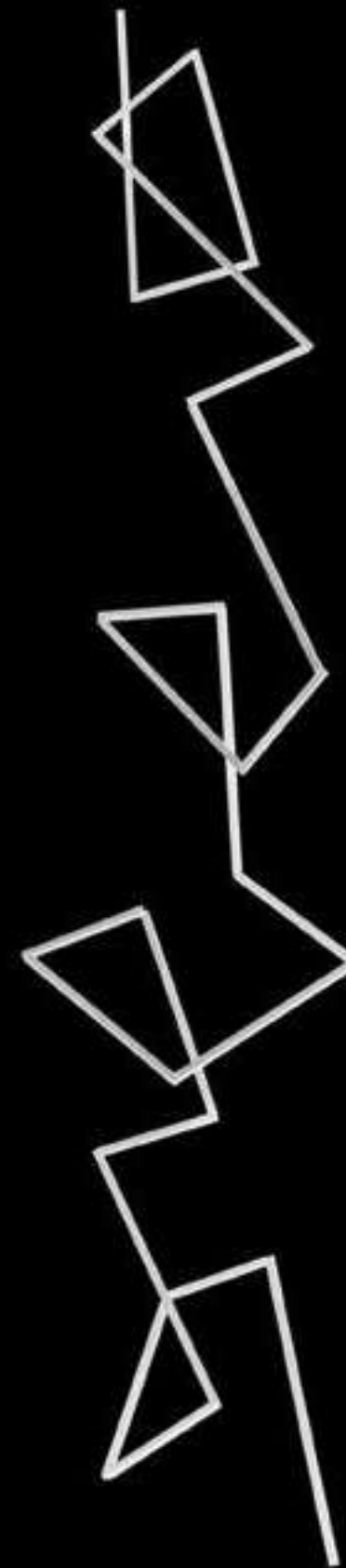



Yak Divano — Sofa / LucidiPevere 2015





**Yak Indoor/Outdoor**  
**LucidiPevere**  
-- 2019





**Yak Indoor/Outdoor** Divano — Sofa  
/LucidiPevere 2019





**Yak Indoor/Outdoor** Poltrona -- Armchair  
/ LucidiPevere 2019  
pag. 180

**Yak Indoor/Outdoor** Divano -- Sofa  
/ LucidiPevere 2019

**Atalante**  
**Jasper Morrison**  
— 2009



LL04 Leather Longue Chair



**Atalante** Divano — Sofa / J. Morrison 2009  
**LL04 Leather Longue Chair** Chaise longue  
/ M. Van Severen 2004 — *Edizioni De Padova*  
**Ishi** Tavolino — Low table / Nendo 2016  
pag. 182.183

**LL04 Leather Longue Chair** Chaise longue  
/ M. Van Severen 2004 — *Edizioni De Padova*

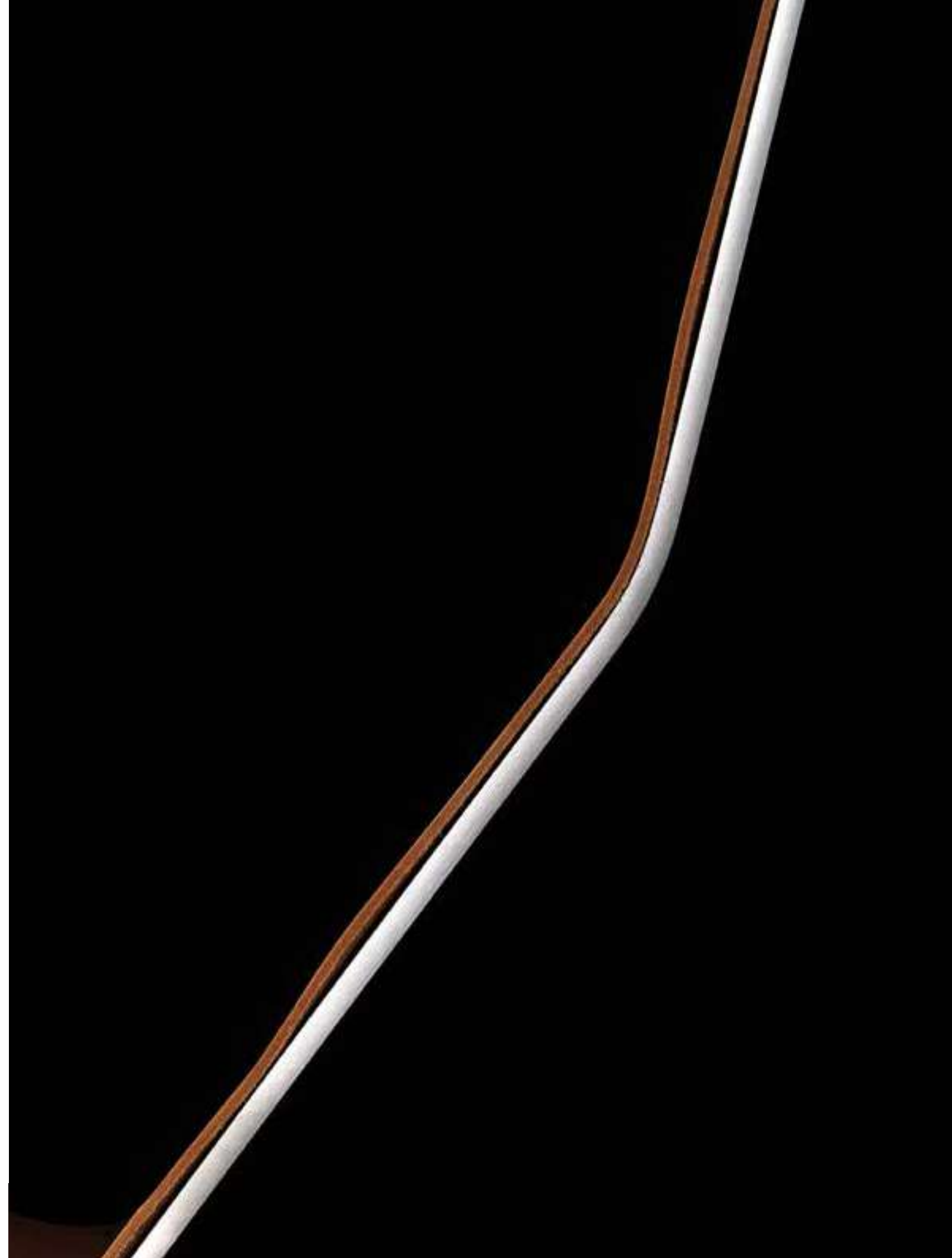





**LL04 Leather Longue Chair** Chaise longue  
/ M. Van Severen 2004 — *Edizioni De Padova*





**Atalante** Divano componibile -- Modular sofa  
/J. Morrison 2009  
**Sen** Tavolino -- Low table/K. Oshiro 2016  
**Sail** Tavolino -- Low table/Nendo 2017  
**Nota** Lampada -- Lamp/E. Ossino 2017  
**Pouf Capitoné** Pouf/2004  
pag. 188.189

**Atalante** Divano componibile -- Modular sofa  
/J. Morrison 2009



**Atalante**

**Atalante** Divano — Sofa / J. Morrison 2009

**192** 193





Sen Tavolino -- Low tables / K. Oshiro 2016



**Chesterfield 16**  
--1983/2016



Dan



**Chesterfield 16** Divano -- Sofa /1983-2016

**Dan** Tavolino -- Low table /J. Møller 1992  
pag. 196.197

**Dan** Tavolino -- Low table /J. Møller 1992

**Collezioni** Collections

Chesterfield 16

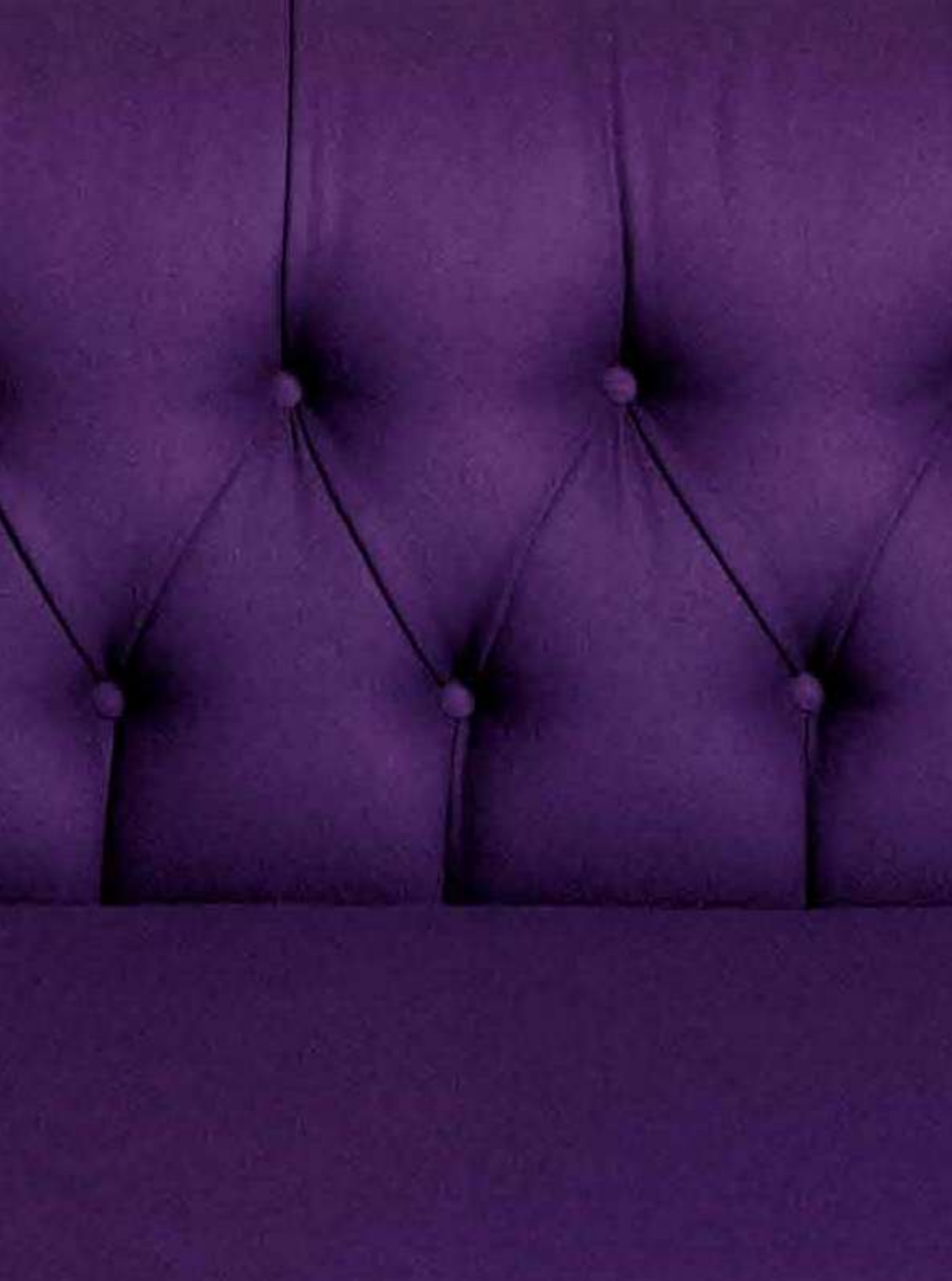

**Chesterfield 16** Divano -- Sofa /1983-2016  
**Sen** Tavolino -- Low table /K. Oshiro 2016

**Collezioni** Collections

**Pillow 19**  
**Vico Magistretti**  
-- 2004/2019





**Pillow 19** Divano — Sofa / V. Magistretti 2004-2019  
**Combi Cabinets** Contenitori — Cabinets / P. Lissoni 2019  
**Connecticut** Tavolino — Low table / J. Risom 1965 — *Edizioni De Padova*  
**Nota** Lampada — Lamp / E. Ossino 2017  
**Art Wood Frame** Specchio — Mirror / P. Lissoni 2019  
**Sail** Tavolino — Low table / Nendo 2017  
**Étiquette** Poltrona — Armchair / GamFratesi 2019  
**Madison** Tappeto — Rug / 2018  
pag. 202.203

**Combi Cabinets** Contenitori — Cabinets / P. Lissoni 2019





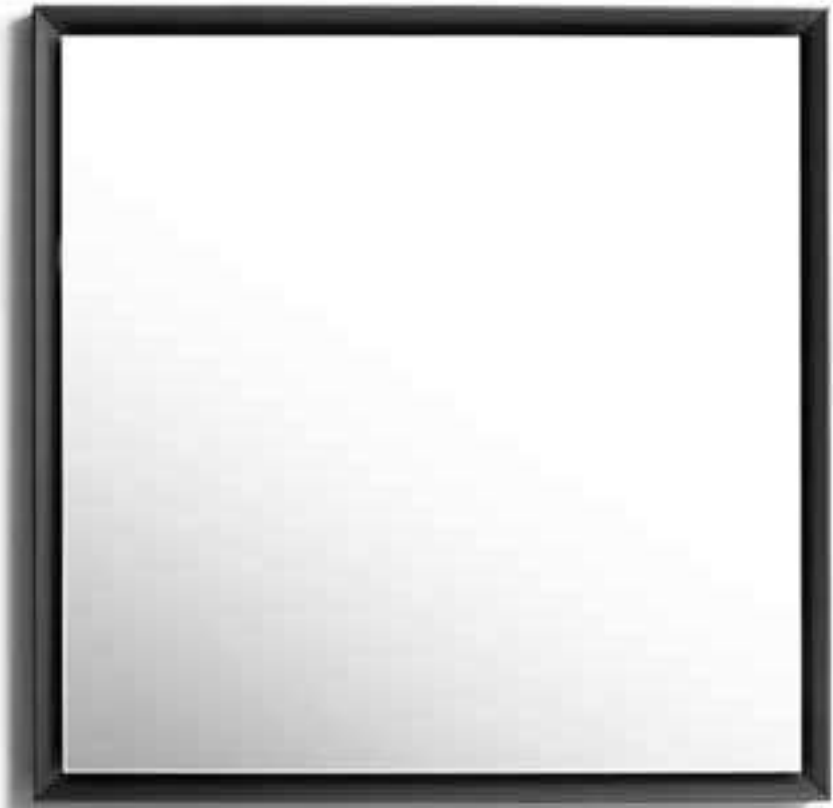

SP14 Wood Frame Specchio — Mirror  
/neunzig° design 2019



Connecticut

**Connecticut** Tavolino -- Low table  
/ J. Risom 1965 -- Edizioni De Padova

208 209



**Collezioni** Collections



**Pillow**  
**Vico Magistretti**  
-- 2004





**Pillow** Divano — Sofa / V. Magistretti 2004

**SC16** Contenitore — Storage unit / 2016

**Sen** Tavolino — Low table / K. Oshiro 2016  
pag. 212.213

**SC16** Contenitore — Storage unit / 2016



Pillow



**Pillow** Divano — Sofa / V. Magistretti 2004



**Pilotis**  
**Philippe Nigro**  
— 2012





**Pilotis** Divano -- Sofa / P. Nigro 2012  
**Dan** Tavolino -- Low table / J. Møller 1992  
pag. 218, 219, 221

Pilotis



**Pilotis** Divano — Sofa / P. Nigro 2012

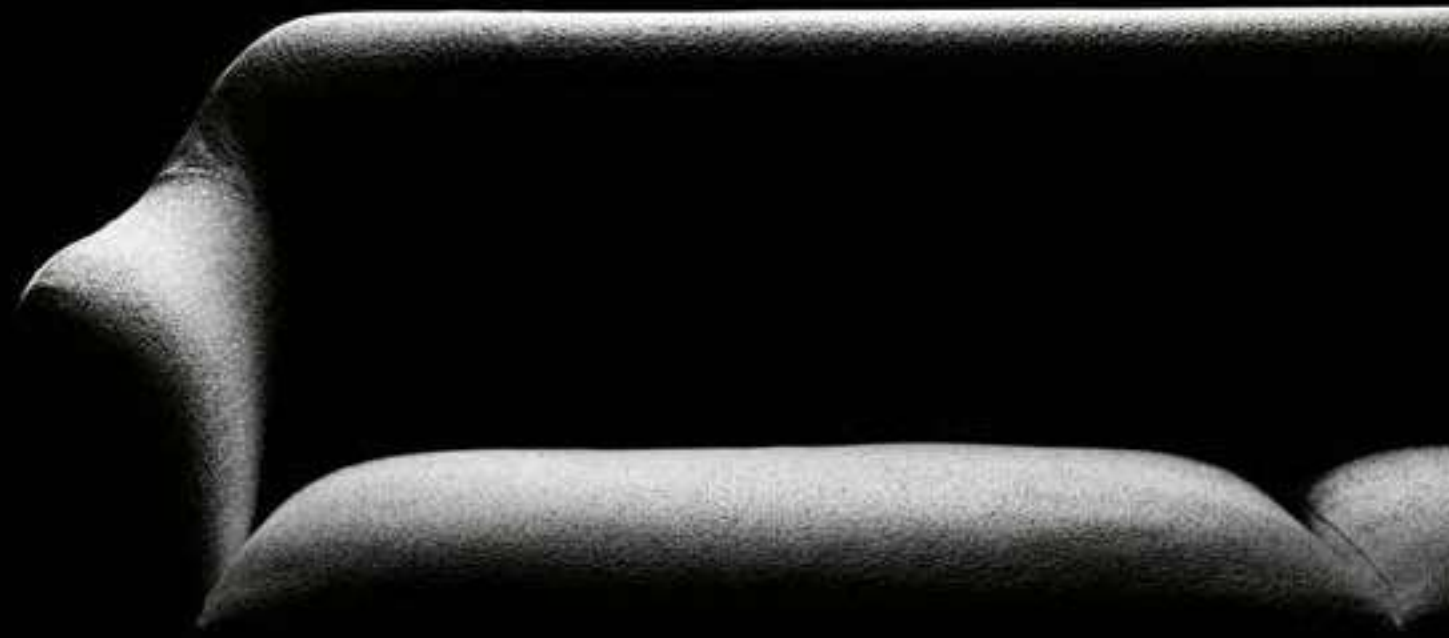



Pilotis Poltrona — Armchair / P. Nigro 2012



**Regent's 16**  
— 1983/2016



Tetris



**Tetris** Tavolino -- Low table / Nendo 2007

**Regent's 16** Divano -- Sofa / 1983-2016

**Pouf Capitoné** Pouf / 2004

**Chab-Table** Tavolino -- Low table / Nendo 2005  
pag. 231







Regent's 16

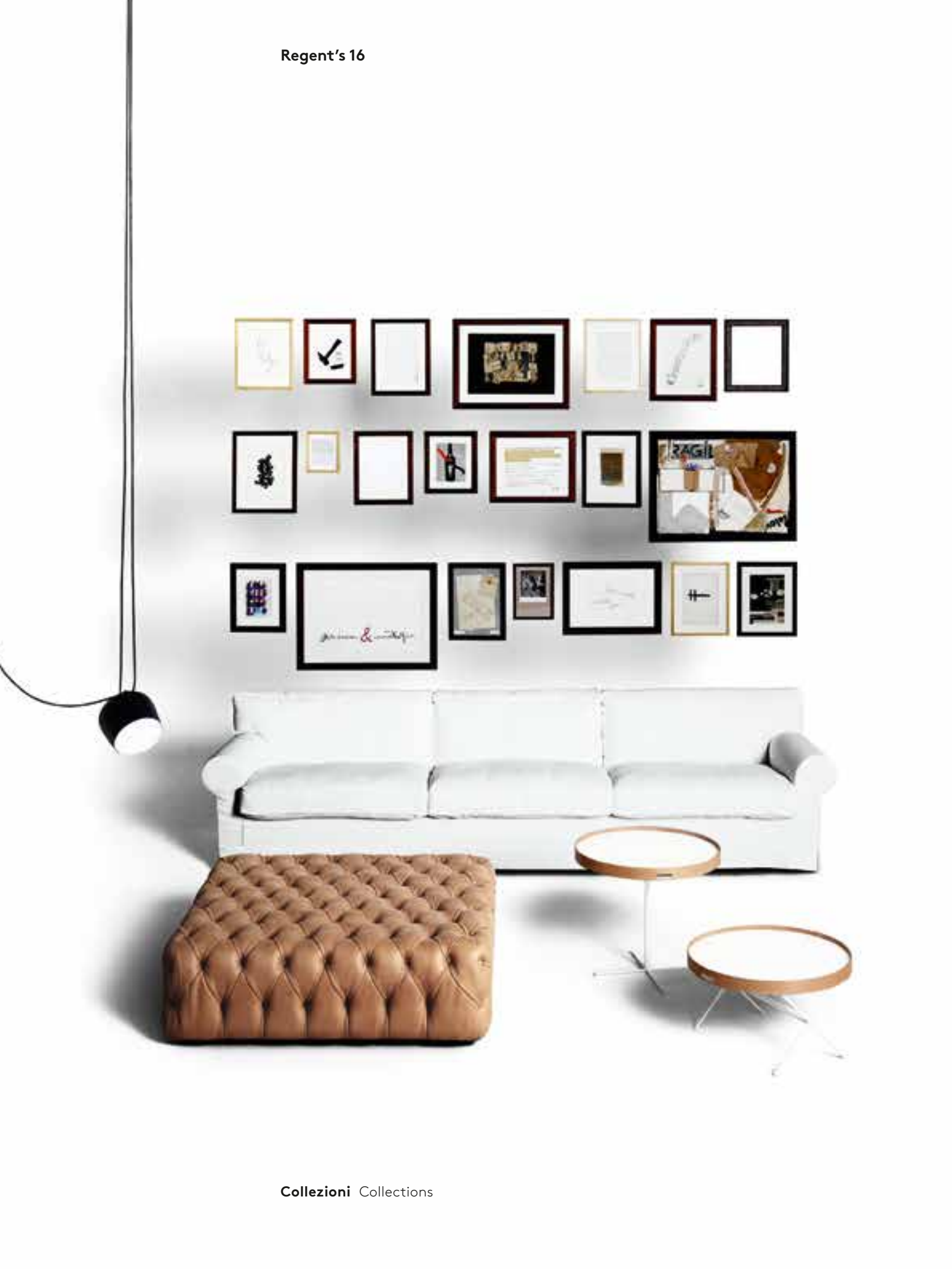

Collezioni Collections

Kant



**Kant** Libreria — Bookcase  
/ Formförsorge 1993

**Albereta**  
**Philippe Nigro**  
— 2015







**Albereta** Poltrona — Armchair / P. Nigro 2015  
**SC16** Contenitore — Storage unit / 2016  
pag. 234.235

**Albereta** Poltrona — Armchair / P. Nigro 2015



**Bistrò**  
**Vico Magistretti**  
-- 2005



**LC03 Low Chair**  
**M. Van Severen**  
**F. Schwaerzler**  
—2003



**LC03 Low Chair** Poltrona — Armchair  
/ M. Van Severen - F. Schwaerzler 2003  
— Edizioni De Padova  
**Ishi** Tavolino — Low table / Nendo 2016  
**Mogura** Lampada — Lamp / Nendo 2016  
pag. 240, 241

**LC03 Low Chair** Poltrona — Armchair  
/ M. Van Severen - F. Schwaerzler 2003  
— Edizioni De Padova



**Tattomi**  
**Jan Armgardt**  
**e Ingo Maurer**  
--1985

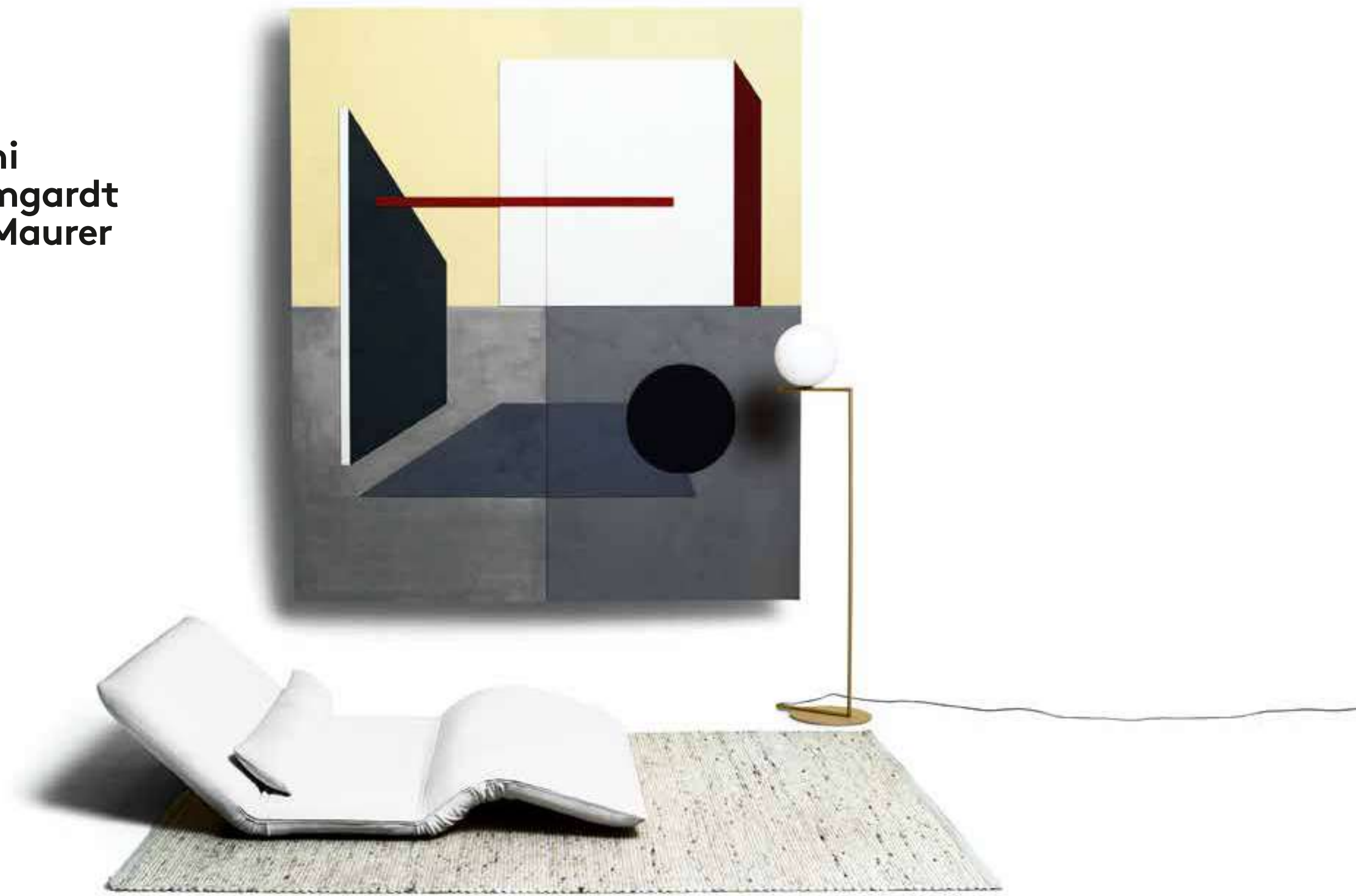



**Tattomi** Poltrona-letto — Armchair-bed  
/J. Armgardt - I. Maurer 1985  
**Tynn** Tappeto — Rug  
pag. 244.245

**Tattomi** Poltrona-letto — Armchair-bed  
/J. Armgardt - I. Maurer 1985  
pag. 247

**Tattomi** Poltrona-letto — Armchair-bed  
/J. Armgardt / I. Maurer 1985

**Mini Mate** Tavolino — Low table / A. Castiglioni 1993

**Basket** Poltrona — Armchair / V. Magistretti 2004

**Tynn** Tappeto — Rug  
pag. 248.249



Tattomi





**Tondo 05** Poltrona — Armchair / V. Magistretti  
/ B. Lohmann 2002-2005



Smeralda



**Smeralda** Poltrona — Armchair  
/A. von Schewen 2014

**Collezioni** Collections

**3Millimetri**  
**Studiocharlie**  
-- 2017





**3Millimetri**



**3Millimetri** Tavolo -- Table / Studiocharlie 2017  
**So** Sedia -- Chair / N. Fukasawa 2017  
**Donziletta** Sedia -- Chair / M. De Lucchi 2017  
**Naviglio** Lampada -- Lamp / P. Lissoni 1995 Boffi  
pag. 254.255

**3Millimetri** Tavolo -- Table / Studiocharlie 2017

**Collezioni** Collections



So Sedia — Chair / N. Fukasawa 2017

Donzelletta



**Donzelletta** Sedia—Chair  
/M. De Lucchi 2017



Donzelletta



**Donzelletta** Sedia — Chair  
/ M. De Lucchi 2017

**Collezioni** Collections

**Carlo**  
**T. Morganti & R. J. Morganti**  
-- 2019



**Carlo** Tavolo -- Table / T. Morganti & R. J. Morganti 2019  
-- Edizioni De Padova  
**Lady Pollack** Sedia -- Chair / V. Magistretti 1998/2016  
**Cirene** Sedia -- Chair / V. Magistretti 1999  
**Elementi** Lampada a sospensione -- Suspension lamp  
/ E. Ossino 2019  
**Combi Open Units** Contenitore a giorno  
-- Open unit / P. Lissoni 2019





**Carlo** Tavolo — Table  
/ T. Morganti & R. J. Morganti 2019  
— Edizioni De Padova





**Carlo** Tavolo — Table  
/ T. Morganti & R. J. Morganti 2019  
— Edizioni De Padova



Carlo

**Carlo** Tavolo -- Table / T. Morganti & R. J. Morganti 2019  
-- *Edizioni De Padova*  
**Lady Pollack** Sedia -- Chair / V. Magistretti 1998/2016  
**Lazy Susan** Vassoio girevole -- Swivel tray  
/ C.R.S. De Padova 2019  
**Elementi** Lampada a sospensione -- Suspension lamp  
/ E. Ossino 2019

270 271





**Combi Open Units** Contenitore a giorno — Open unit  
/ P. Lissoni 2019



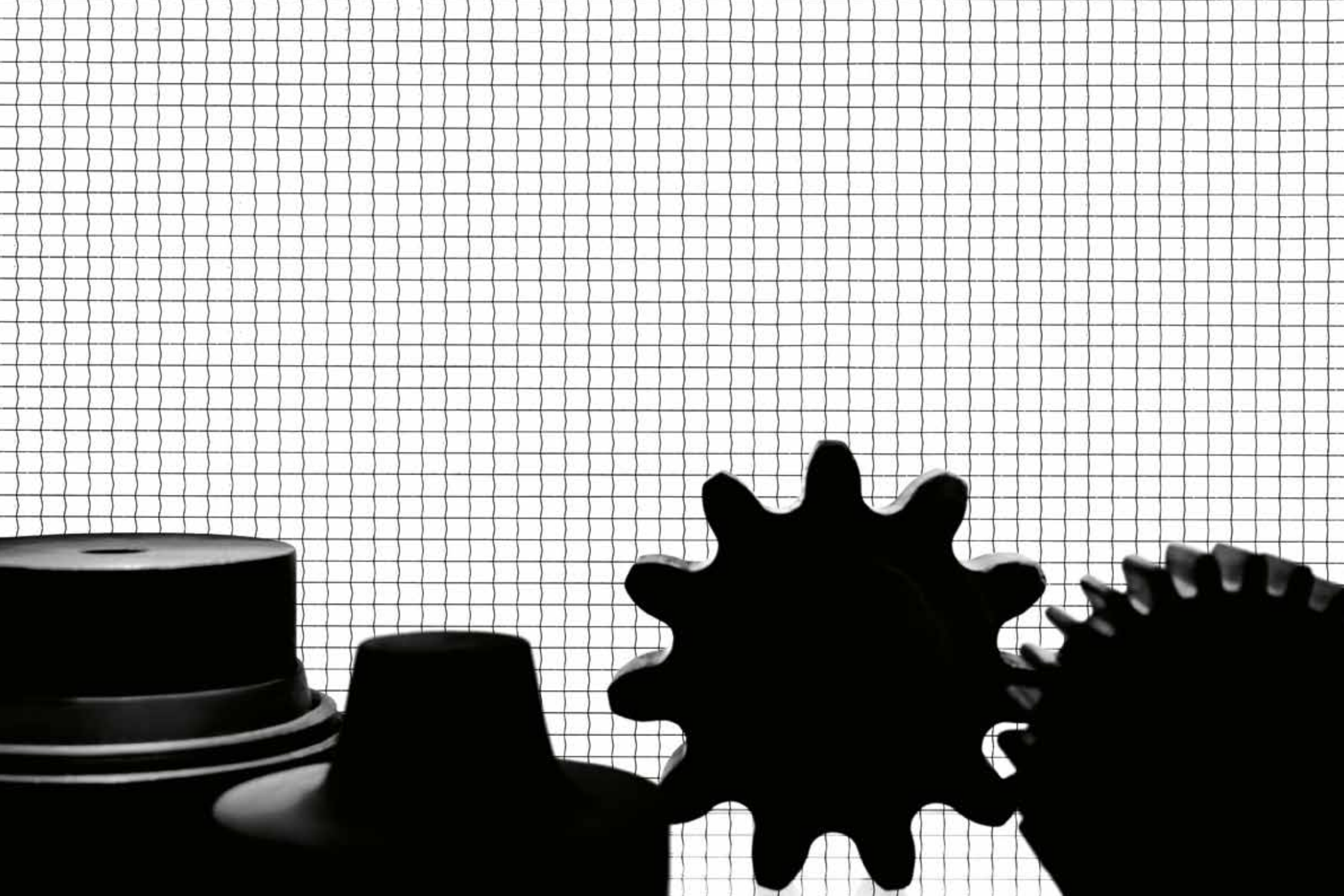



Cirene



**Cirene** Sedia — Chair / V. Magistretti 1999

**Collezioni** Collections

**Campo D'Oro**  
**Paolo Pallucco**  
**e Mireille Rivier**  
— 2005





**Campo D'Oro** Tavolo — Table  
/ P. Pallucco - M. Rivier 2005  
**Lavenham Executive** Sedia — Chair  
/ P. Urquiola 2010  
pag. 278, 279

**Campo D'Oro** Tavolo — Table  
/ P. Pallucco - M. Rivier 2005



**Otis**  
**Lorenz\*Kaz**  
-- 2007/2008



**Otis** Tavolo — Table / Lorenz\*Kaz 2007–2008  
**Silver** Sedia — Chair / V. Magistretti 1989  
pag. 282, 283, 285





**Quadrato**  
--1986



Silver



**Quadrato** Tavolo -- Table /1986  
**Silver** Sedia -- Chair /V. Magistretti 1989  
pag. 286.287

**Silver** Sedia -- Chair /V. Magistretti 1989



Silver



Silver Sgabello— Stool / V. Magistretti 1989

Collezioni Collections

**Shadow**  
**V. Van Duysen**  
— 2011/2018





Shadow

**Shadow** Tavolo -- Table / V. Van Duysen 2011-2018  
**Donziletta** Sedia -- Chair / M. De Lucchi 2017  
**Elementi** Lampada a sospensione  
-- Suspension lamp / E. Ossino 2019  
**So** Sedia -- Chair / N. Fukasawa 2017  
**Combi Open Units** Contenitore a giorno  
-- Open unit / P. Lissoni 2019  
pag. 292.293

**Collezioni** Collections



Shadow



**Shadow** Tavolo -- Table  
/ V. Van Duysen 2011-2018

Donzella



**Donzella** Sedia—Chair / M. De Lucchi 2013

**Collezioni** Collections

**Shine**  
**Vico Magistretti**  
— 1991



Shine

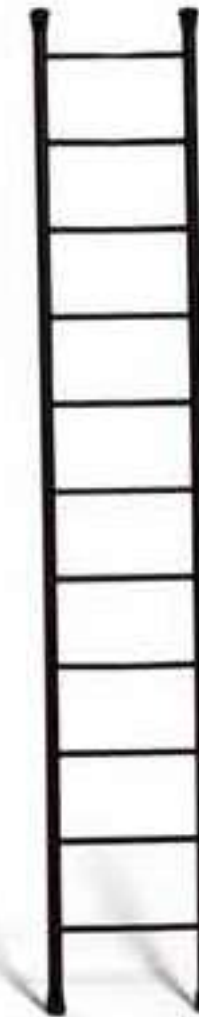

**Shine** Tavolo -- Table / V. Magistretti 1991  
**606 Universal Shelving System**  
Libreria -- Bookcase / 1984  
**Chesto** Sedia -- Chair / P. Norguet 2014  
pag. 301

**Shine** Tavolo -- Table / V. Magistretti 1991  
**Silver** Sedia -- Chair / V. Magistretti 1989  
**Cirene** Sedia -- Chair / V. Magistretti 1999  
**Uragano** Sedia -- Chair  
/ V. Magistretti 1992-2015  
**Chesto** Sedia -- Chair  
/ P. Norguet 2014  
**Sundance** Sedia -- Chair / P. Golinelli 2010  
pag. 302.303

Sundance

**Sundance** Sedia -- Chair / P. Golinelli 2010  
**Shine** Tavolo -- Table / V. Magistretti 1991

304 305





Sundance



**Sundance** Sedia -- Chair / P. Golinelli 2010

**Collezioni** Collections

**Mawari**  
**G. Pelgrims**  
-- 2019





**Mawari** Tavolo -- Table / G. Pelgrims 2019

**M16** Sedia -- Chair 2016

**Poet** Lampada a sospensione -- Suspension lamp / K. Takeuchi 2019

**Chesto** Sedia -- Chair / P. Norguet 2014

**Combi Open Units** Contenitore a giorno -- Open Unit / P. Lissoni 2019  
pag. 308.309

**Mawari** Tavolo -- Table / G. Pelgrims 2019

**M16** Sedia -- Chair 2016

**Poet** Lampada a sospensione -- Suspension / K. Takeuchi, 2018-2019

**Collezioni** Collections







**Combi Open Units** Contenitore a giorno  
— Open Unit / P. Lissoni 2019



Combi Madia Madia — Sideboard  
/ P. Lissoni 2019



Olimpia

Olimpia Sgabello Stool / 2019

318 319



Collezioni Collections

**Tavolo '95**  
**Achille Castiglioni**  
— 1995/2018





**Tavolo '95** Tavolo — Table / A. Castiglioni 1995-2018  
**Chesto** Sedia — Chair  
/ P. Norguet 2014

Chesto

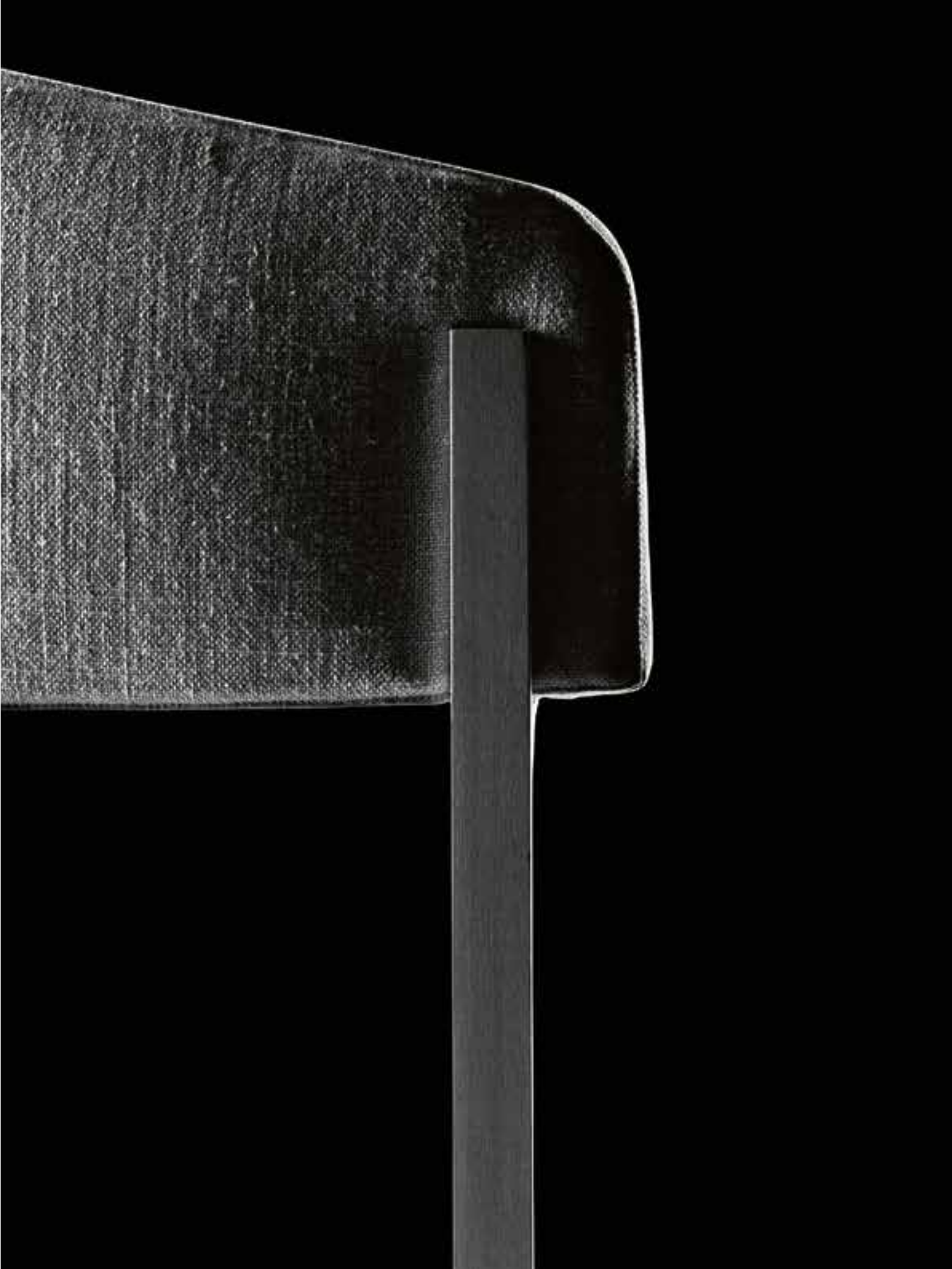

**Chesto** Sedia — Chair  
/ P. Norguet 2014





**Tavolo '95** Tavolo — Table  
/A. Castiglioni 1995-2018  
**Shigeto Box** Contenitore a giorno — Open cupboard  
/V. Magistretti 1990  
**Rea** Sedia — Chair /P. Tilche 1956 — *Edizioni De Padova*  
**Elementi** Lampada — Lamp /E. Ossino 2018

Rea



**Rea** Sedia — Chair / P. Tilche 1956 — *Edizioni De Padova*





**Tavolo '95** Tavolo — Table / A. Castiglioni 1995-2018  
**Shigeto Box** Contenitore a giorno — Open cupboard  
/ V. Magistretti 1990  
**Rea** Sedia — Chair / P. Tilche 1956 — *Edizioni De Padova*  
**Elementi** Lampada — Lamp / E. Ossino 2018

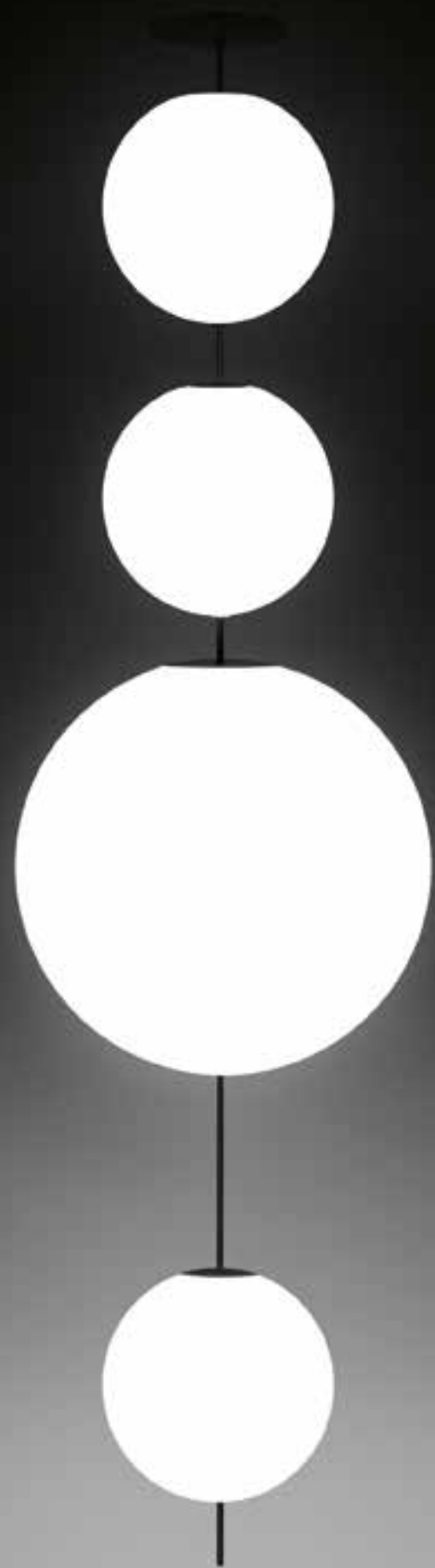

Elementi



**Elementi** Lampada -- Lamp  
/E. Ossino 2018-2019

**Collezioni** Collections



**Tavolo '95** Tavolo  
—Table/A. Castiglioni 1995-2018  
**Shigeto Box** Contenitore a giorno  
—Open cupboard/V. Magistretti 1990  
**Lady Pollack** Sedia— Chair/V. Magistretti 2016  
**Mogura** Lampada— Lamp/Nendo 2016





Pollack Sedia — Chair / V. Magistretti 1998

Tavolo '95



**Tavolo '95** Tavolo — Table  
/A. Castiglioni 1995-2018  
**Uragano** Sedia — Chairs  
/V. Magistretti 1992  
pag. 338

**Tavolo '95** Tavolo — Table  
/A. Castiglioni 1995-2018

**Collezioni** Collections



**Tavolo '95** Tavolo — Table / A. Castiglioni 1995-2018  
**Uragano** Sedia — Chair  
/ V. Magistretti 1992

Tavolo '95



**Tavolo '95** Tavolo — Table  
/A. Castiglioni 1995-2018

**Collezioni** Collections

Uragano

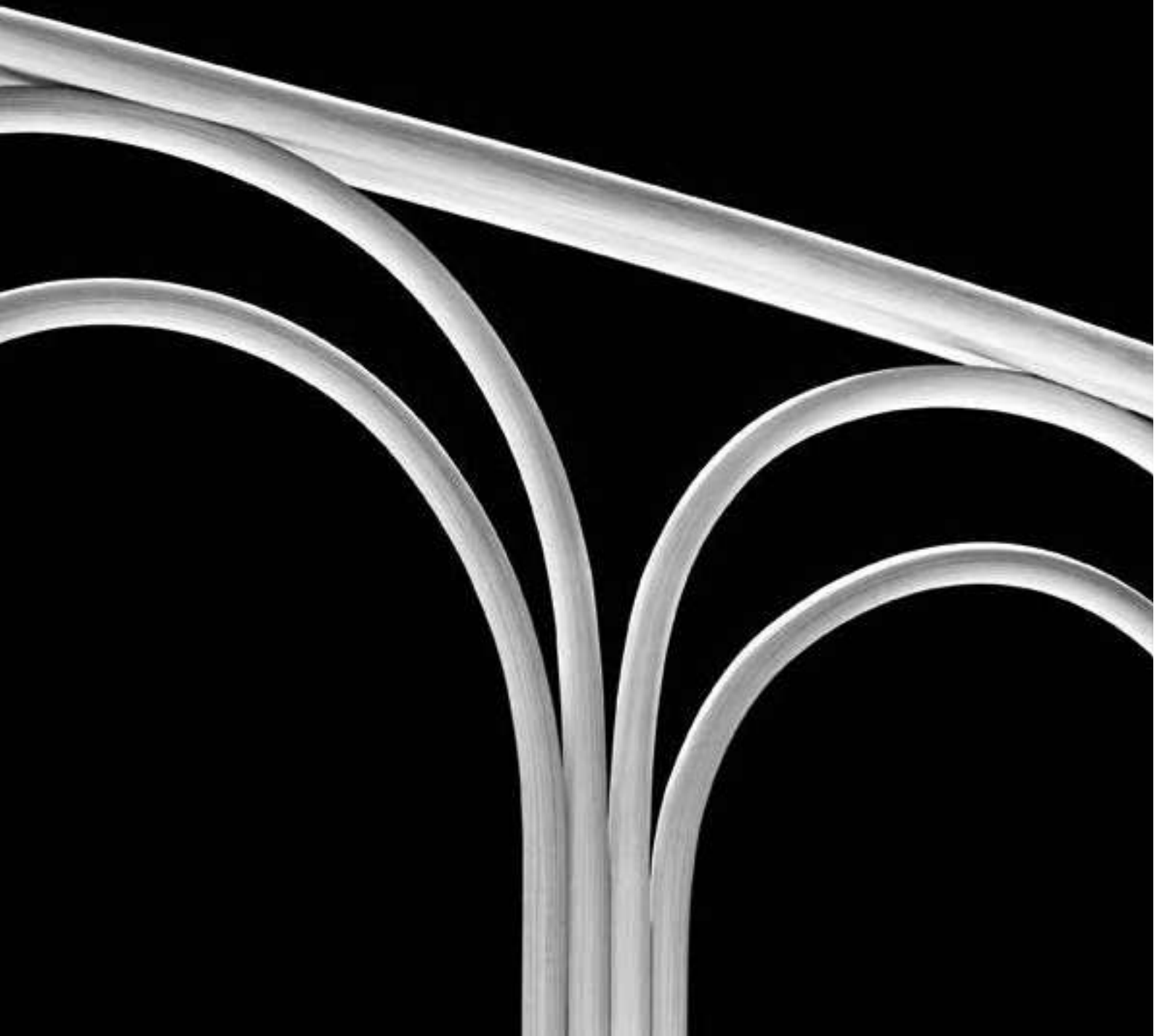

**Uragano** Sedia — Chair  
/V. Magistretti 1992

**Collezioni** Collections



**Tools**  
**Studio Cerri & Associati**  
-- 2002



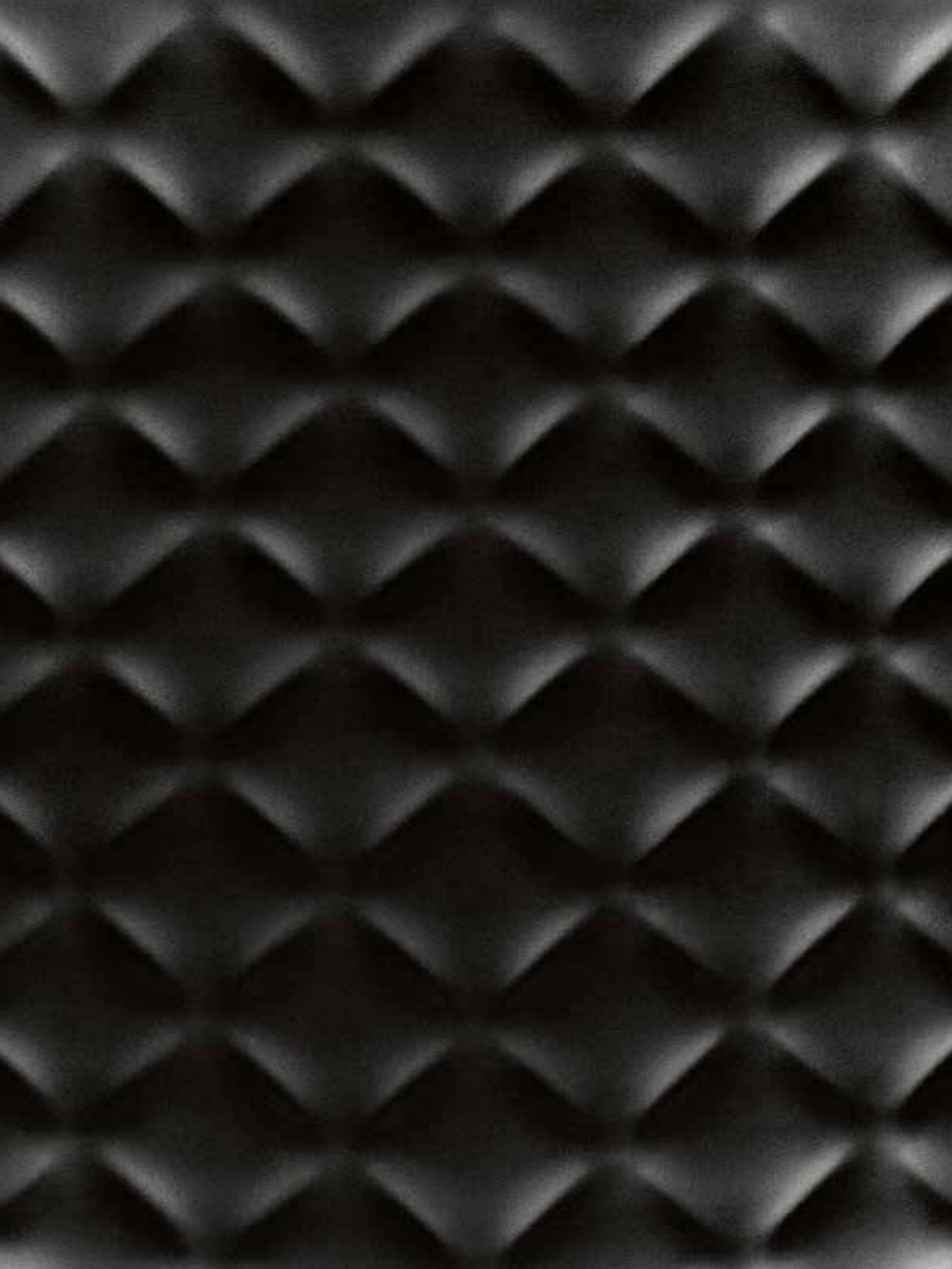

## Lavenham Executive



**Tools** Tavolo -- Table  
/ Studio Cerri & Associati 2002  
**Lavenham Executive** Sedia -- Chair  
/ P. Urquiola 2010  
pag. 346.347

**Lavenham Executive** Sedia -- Chair  
/ P. Urquiola 2010

**Collezioni** Collections



**Tools** Tavolo — Table  
/ Studio Cerri & Associati 2002

# Vidun Vico Magistretti — 1987



**Vidun** Tavolo — Table / V. Magistretti 1987  
**Shigeto** Contenitore — Cupboard / V. Magistretti 1989  
**Silver** Sedia — Chair / V. Magistretti 1989  
**DT Light** Lampada — Lamp / P. Luithlen 2003



**Vidun** Tavolo — Table / V. Magistretti 1987  
**M16** Sedia — Chair / 2016  
**L.O.P.** Lampada — Lamp  
/ C.R.S. Boffi 2009-2012 Boffi





M16 Sedia — Chair / 2016

Vidun

Vidun Tavolo — Table  
/V. Magistretti 1987

358 359

Collezioni Collections



# French Concession Piero Lissoni --2019

**French Concession** Tavolo -- Table  
/ P. Lissoni 2019  
**M16** Sedia -- Chair / 2016  
**Elementi** Lampada -- Lamp  
/ E. Ossino 2018

360 361



Collezioni Collections



**Marocca** Sedia -- Chair / V. Magistretti 1987

**Florinda**  
**Monica Förster**  
-- 2011





# 606 Universal Shelving System -- 1984



## 606 Universal Shelving System

Libreria -- Bookcase / 1984

**Louisiana** Poltrona-pouf

-- Armchair-pouf / V. Magistretti / Centro Design Binfaré 1993

**Chab-Table** Tavolino -- Low table

/ Nendo 2005



**606 Universal Shelving System**  
Libreria -- Bookcase / 1984

Louisiana



**Louisiana** Poltrona-pouf -- Armchair-pouf  
/V. Magistretti/Centro Design Binfaré 1993

**Collezioni** Collections

Louisiana



**Louisiana** Poltrona-pouf -- Armchair-pouf  
/V. Magistretti/Centro Design Binfaré 1993

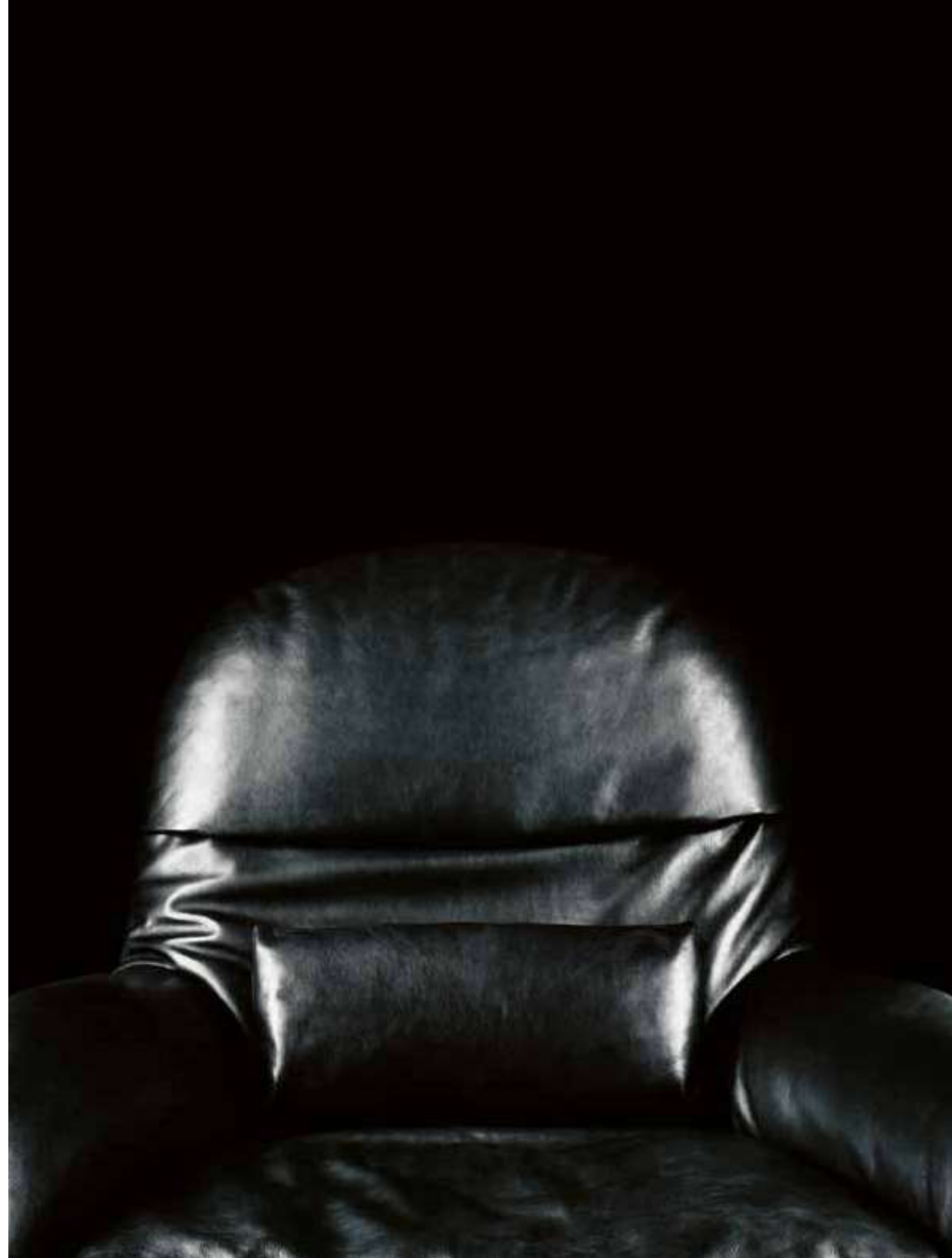







**606 Universal Shelving System**  
Libreria -- Bookcase / 1984  
**Silver** Sedia -- Chair / V. Magistretti 1989  
**Quadrato** Tavolo -- Table / 1986  
pag. 374.375

**606 Universal Shelving System**  
Libreria -- Bookcase / 1984





**606 Universal Shelving System**  
Libreria -- Bookcase / 1984



**Combi Cabinets**  
**Piero Lissoni**  
— 2019



## Combi Cabinets



**Combi Cabinets** Contenitore -- Cabinet  
/ P. Lissoni 2019

**Anna** Lampada -- Lamp / P. Tilche 1962 -- *Edizioni De Padova*  
p 380.381

**Combi Cabinets** Contenitore -- Cabinet  
/ P. Lissoni 2019

**Collezioni** Collections



**Combi Sideboard** Contenitore — Cabinet / P. Lissoni 2019  
**Anna** Lampada — Lamp / P. Tilche 1962 — Edizioni De Padova



Anna

Anna Lampada — Lamp / P. Tilche 1962 — Edizioni De Padova

386 387



Combi Cabinets



**Combi Cabinets** Contenitore  
— Cabinet / P. Lissoni 2019

Combi Cabinets



**Combi Cabinets** Contenitore  
— Cabinet / P. Lissoni 2019



**SC16**  
-- 2016



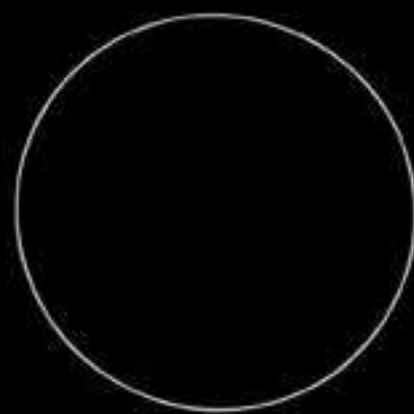

**SC16** Contenitore -- Storage unit / 2016  
**LL04 Leather Longue Chair** Chaise longue  
/ M. Van Severen 2004 -- *Edizioni De Padova*  
pag. 392.393

**SC16** Contenitore -- Storage unit / 2016





SC16 Contenitore — Storage unit / 2016

**Shigeto**  
**Vico Magistretti**  
— 1989



Shigeto

**Shigeto** Contenitore—Cupboard  
/V. Magistretti 1989

**400** 401



**Shigeto Box**  
**Vico Magistretti**  
— 1990







## Shigeto Box

**Shigeto Box** Contenitore a giorno  
— Open cupboard / V. Magistretti 1990

**Collezioni** Collections



**Tani Moto**  
**Vico Magistretti**  
— 1991





Tani Moto



**Tani Moto** Libreria — Bookcase  
/V. Magistretti 1991  
**Chab-Table** Tavolino — Low table / Nendo 2005  
**Pilotis** Poltrona — Armchair / P. Nigro 2012  
pag. 406.407

**Tani Moto** Libreria — Bookcase  
/V. Magistretti 1991

**Collezioni** Collections

**Console**  
-- 2003

**Rokumaru  
Nendo**  
-- 2008







**Scrittarello**  
**Achille Castiglioni**  
— 1996





## Scrittarello



**Scrittarello** Scrittoio -- Writing desk  
/ A. Castiglioni 1996  
**Incisa** Sedia -- Chair  
/ V. Magistretti / Centro Design Binfaré 1992  
**Nota** Lampada -- Lamp / E. Ossino 2017  
**R.I.G. Modules** Libreria -- Bookcase  
/ M. Harrsen 2012 MA/U Studio  
pag. 414.415

**Scrittarello** Scrittoio -- Writing desk  
/ A. Castiglioni 1996

**Scrittarello** Scrittoio -- Writing desk  
/ A. Castiglioni 1996  
**Incisa** Sedia -- Chair  
/ V. Magistretti / Centro Design Binfaré 1992  
pag. 417



**Asseman**  
**Patrizia Cagliani**  
— 1984



418 419



Collezioni Collections



**Asseman** Letto — Bed / P. Cagliani 1984  
**Dan** Tavolino — Low table / J. Møller 1992  
**Susanna** Poltrona — Armchair / V. Magistretti 1990  
pag. 418.419

**Asseman** Letto — Bed / P. Cagliani 1984

**Susanna** Poltrona — Armchair / V. Magistretti 1990  
pag. 421



**Asseman Open**  
**Patrizia Cagliani**  
— 2015



**Asseman Open**



**Asseman Open** Letto — Bed / P. Cagliani 2015

**Mini Mate** Tavolino — Low table

/ A. Castiglioni 1993

**Basket** Poltrona — Armchair

/ V. Magistretti 2004

pag. 422.423

**Asseman Open** Letto — Bed / P. Cagliani 2015

**Collezioni** Collections





**Mate** Tavolino — Low table / A. Castiglioni 1992  
pag. 426

**Mini Mate** Tavolino — Low table  
/ A. Castiglioni 1993



**Asseman Open** Letto -- Bed / P. Cagliani 2015  
**Sen** Tavolino -- Low table / K. Oshiro 2016  
**Firefly** Lampada -- Lamp / A. Åhnebrink 2016  
**Raffles** Poltrona -- Armchair / V. Magistretti 1988

Firefly



Firefly Lampada — Lamp/A. Ahnebrink 2016

**Blendy**  
**Omi Tahara**  
— 2019



## Blendy



**Blendy** Letto -- Bed / O. Tahara 2019  
**Blendy** Poltrona -- Armchair / O. Tahara 2018  
**Connecticut** Tavolino -- Low table / J. Risom 1965 -- Edizioni De Padova  
**Elementi** Lampada a sospensione -- Suspension lamp / E. Ossino 2019  
**Mate** Tavolino -- Low table / A. Castiglioni 1992  
**Combi Pouf** Pouf / P. Lissoni 2019  
**Madison** Tappeto -- Rug / 2018  
**R.I.G. Modules** Libreria -- Bookcase / M. Harrsen 2012 MA/U Studio  
pag. 432.433

**Blendy** Letto -- Bed / O. Tahara 2019







**Combi Pouf**



**Connecticut** Tavolino — Low table  
/ J. Risom 1965 — *Edizioni De Padova*  
**Elementi** Lampada a sospensione  
— Suspension lamp / E. Ossino 2019  
**Blendy** Letto — Bed / O. Tahara 2019  
**R.I.G. Modules** Libreria — Bookcase  
/ M. Harrsen 2012 MA/U Studio  
pag 436.437

**Combi Pouf** Pouf / P. Lissoni 2019



**Connecticut**



**Connecticut** Tavolino -- Low table  
/ J. Risom 1965 -- Edizioni De Padova

**Erei**  
**Elisa Ossino**  
-- 2018



Erei



**Erei** Letto — Bed/E. Ossino 2018  
**Erei** Tavolino — Low table/E. Ossino 2018  
**Chesto Lounge** Sedia — Chair/P. Norguet 2018  
**Elementi** Lampada — Lamp/E. Ossino 2018  
**Sen** Tavolino — Low table/K. Oshiro 2016/2018  
**Nota** Lampada — Lamp/E. Ossino 2017  
**Madison** Tappeto — Rug/2018  
pag. 442.443

**Erei** Letto — Bed/E. Ossino 2018

**Collezioni** Collections



Erei



**Erei** Letto — Bed / E. Ossino 2018  
**Erei** Tavolino — Low table / E. Ossino 2018  
**Chesto Lounge** Sedia — Chair / P. Norguet 2018  
**Elementi** Lampada — Lamp / E. Ossino 2018  
**Sen** Tavolino — Low table / K. Oshiro 2016 / 2018  
**Nota** Lampada — Lamp / E. Ossino 2017  
**Madison** Tappeto — Rug / 2018

**Garderobier**



**Garderobier** Servomuto — Valet stand  
/L. Banovic 2018

Étiquette  
GamFratesi  
— 2019





**Étiquette** Letto -- Bed / GamFratesi 2019  
**Anna** Lampada -- Lamp / P. Tilche 1962 -- *Edizioni De Padova*  
**Combi Cabinets** Contenitore -- Cabinet / P. Lissoni 2019  
**Sen** Tavolino -- Low table / K. Oshiro 2016  
**Sail** Tavolino -- Low table / Nendo 2017  
**Wingback** Poltrona -- Armchair / P. McCobb 1956 -- *Edizioni De Padova*  
**Ottoman for Wingback** Pouf / 1956 -- *Edizioni De Padova*  
**Art Wood Frame** Specchio -- Mirror / P. Lissoni 2019  
**Madison** Tappeto -- Rug / 2018  
pag. 450.451

**Étiquette** Letto -- Bed  
/ GamFratesi 2019

Étiquette



Collezioni Collections





Art Wood Frame



**Étiquette** Letto -- Bed / GamFratesi 2019  
**Combi Cabinets** Contenitore -- Cabinet / P. Lissoni 2019  
**Anna** Lampada -- Lamp / P. Tilche 1962 -- *Edizioni De Padova*  
**Sail** Tavolino -- Low table / Nendo 2017  
**Madison** Tappeto -- Rug / 2018  
pag. 454.455

**Art Wood Frame** Specchio -- Mirror / P. Lissoni 2019  
**Anna** Lampada da tavolo -- Table lamp / P. Tilche 1962 -- *Edizioni De Padova*



**Sleeping Car**  
**Vico Magistretti**  
— 2004



Sleeping Car

**Sleeping Car** Letto -- Bed / V. Magistretti 2004  
**Chab-Table** Tavolino -- Low table / Nendo 2005  
pag. 460.461

**Sleeping Car** Letto -- Bed / V. Magistretti 2004







**Poltrone e Divani**  
— Armchairs and Sofas

**Albereta** — Philippe Nigro, 2015

Poltrona. Struttura in acciaio con cinghie elastiche. Gambe in massello di frassino tinto color rovere naturale o noce canaletto. Piedini in termoplastica. Imbottitura in poliuretano espanso a quote differenziate e ovatta di poliestere rivestito con vellutino di poliestere. Cuscino di seduta in piuma d'oca con supporto in poliuretano espanso a quote differenziate rivestito in tela di cotone. Rivestimento sfoderabile in tessuto o fisso in velluto o pelle.

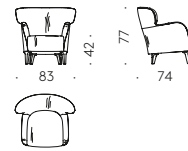

Armchair. Frame in steel with elastic straps. Legs in solid ash wood, natural oak-stained or stained in Canaletto walnut. Thermoplastic feet. Padding in variable-density polyurethane foam and polyester wadding, covered by light polyester velvet. Seat cushion in goose down with support in variable-density polyurethane foam covered with cotton cloth. Removable cover in fabric or non-removable in leather and velvet.

**Atalante** — Jasper Morrison, 2009

Divano a due o più posti o componibile. Struttura in acciaio e legno con cinghie elastiche. Piedini in materiale termoplastico. Imbottitura in poliuretano espanso a quote differenziate, memory foam e ovatta di poliestere rivestito con vellutino di poliestere e tela di cotone. Rivestimento sfoderabile in tessuto o fisso in pelle. Optional: cuscini schienale (in piuma d'oca, rivestito con tela di cotone con rullo poggiatesta in poliuretano espanso rivestito in ovatta di poliestere) e cuscini volanti (in piuma d'oca mista a fibra di poliestere rivestito con tela di cotone).

Two or more-seater sofa and modular sofa. Frame in steel and wood with elastic straps. Feet in thermoplastic feet. Padding in variable-density polyurethane foam, memory foam and polyester wadding, covered by light polyester velvet and cotton cloth. Removable cover in fabric or non-removable in leather. Optional: Backrest cushions (in goose down covered in cotton cloth with headrest in polyurethane foam, covered with polyester wadding) and loose cushions (in goose down mixed with polyester fibres, covered in cotton cloth).

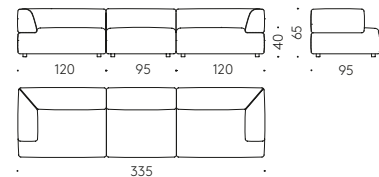
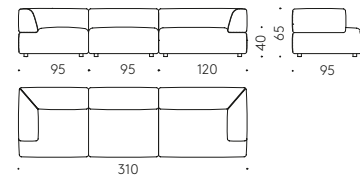
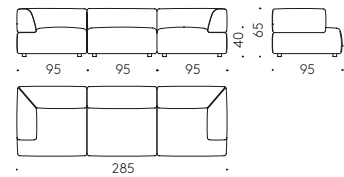
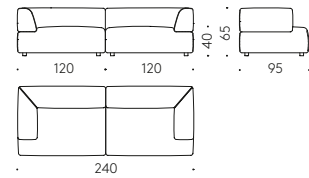
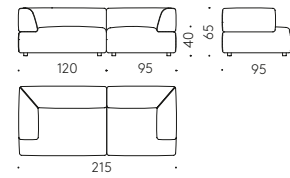
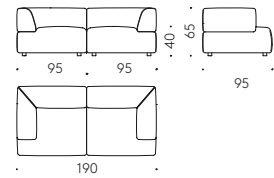

elementi terminali/end elements

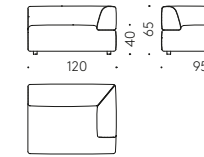
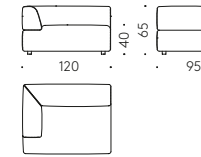
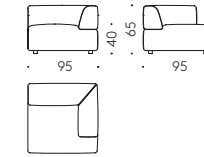
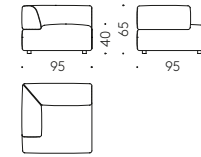

elementi centrali/central elements

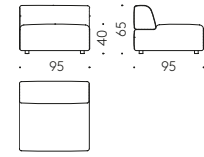

elementi angolari/corner elements

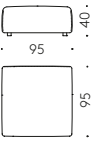
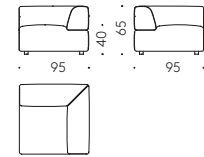

esempi di composizione/compositions

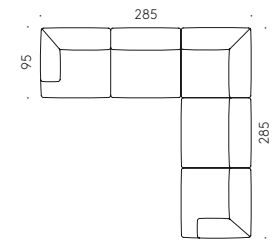
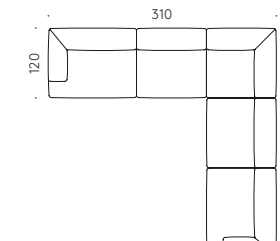
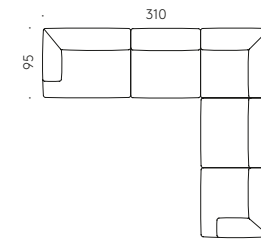
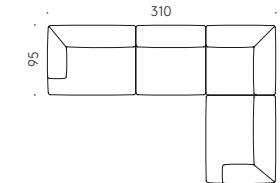
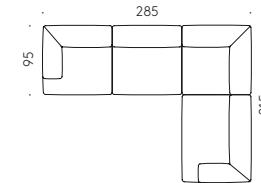

cuscini/cushions

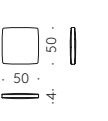
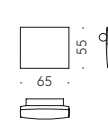

**Poltrone e Divani**  
— **Armchairs and Sofas**

**Basket** — Vico Magistretti, 2004

Poltroncina con base a dondolo o base girevole. Scocca con inserto in acciaio con cinghie elastiche. Imbottitura in poliuretano espanso rivestito con vellutino di poliestere. Base: versione a dondolo in acciaio spazzolato fine, pattino in legno massello di frassino tinto color rovere o wengè. Versione girevole in acciaio cromato con supporto sedile in acciaio verniciato color alluminio e piedino in materiale termoplastico. Rivestimento fisso in tessuto o in pelle.

Small armchair with rocking or swivel base. In steel with elastic straps. Body in padding in polyurethane foam, covered by light polyester velvet. Base: rocking chair in fine brushed stainless steel, rockers in ash wood, oak or wenge stained. Swivel chair: chromium-plated steel, seat support in steel coated, aluminium coloured. Thermoplastic foot. Non-removable cover in fabric or leather.

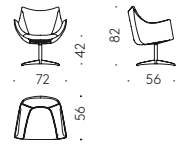
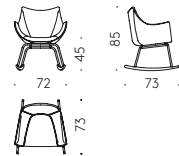

**Bergère** — Patricia Urquiola, 2007/2015

Bergère. Struttura in acciaio con cinghie elastiche. Base in massello di frassino tinto color rovere o noce canaletto. Piedini regolabili in materiale termoplastico. Imbottitura in poliuretano espanso a quote differenziate e ovatta di poliestere rivestito con vellutino di poliestere. Cuscino poggiatesta in piuma d'oca rivestita con tela di cotone. Rivestimento sfoderabile con cerniera zip, in tessuto o in pelle, imbottito in ovatta di poliestere, bordato con fettuccia di cotone o di pelle.

Bergère. Frame in steel with elastic straps. Base in solid ash wood, oak or Canaletto walnut stained. Thermoplastic adjustable feet. Padding in variable-density polyurethane foam, memory foam and polyester wadding, covered by light polyester velvet and cotton cloth. Lumbar support cushion in goose down covered with cotton cloth. Removable cover with zipper, in fabric or leather, padded with polyester wadding and edged with cotton or leather tape.

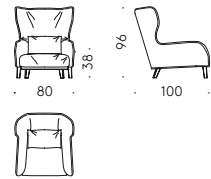

**Bistrò** — Vico Magistretti, 2005

Poltroncina. Schienale in multistrato di betulla impiallacciato wengè. Telaio in acciaio con cinghie elastiche. Gambe in estruso di alluminio verniciato colore nero. Seduta con imbottitura in poliuretano espanso e ovatta di poliestere, rivestiti con vellutino di poliestere. Rivestimento sfoderabile in tessuto o fisso in velluto o pelle.

Small armchair. Backrest in birch plywood, wengè veneered. Legs in anodised extruded aluminium profile black coated. Frame in steel with elastic straps. Padding in variable-density polyurethane foam, memory foam and polyester wadding, covered by light polyester velvet and cotton cloth. Removable cover in fabric or non-removable in velvet or leather.

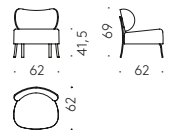

**Blendy** — Omi Tahara, 2018

Poltrona e divano a due-tre posti. Struttura in acciaio con cinghie elastiche. Gambe in acciaio verniciato color nero opaco con piedini in materiale termoplastico. Imbottitura in poliuretano a quote differenziate e ovatta di poliestere rivestito con vellutino di poliestere. Cuscini di seduta in piuma d'oca con supporto in poliuretano espanso a quote differenziate rivestito in tela di cotone. Cuscini di schienale e volanti in piuma d'oca rivestiti in tela di cotone. Rivestimento sfoderabile in tessuto o fisso in velluto o pelle.

Armchair and two or more-seater sofa. Frame in steel with elastic straps. Legs in matt black coated steel with feet in thermoplastic material. Padding in variable-density polyurethane foam, covered by light polyester velvet. Seat cushions in goose down with support in polyurethane foam covered in cotton cloth. Back and loose cushions in goose down. Removable cover in fabric or non-removable in leather and velvet.

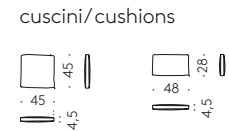
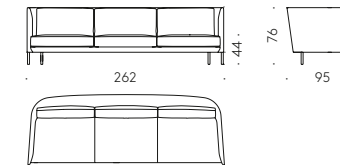
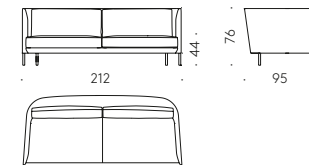
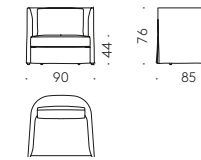
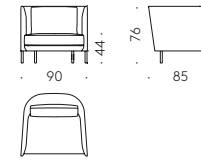

**Blendy Lounge** — Omi Tahara, 2019

Poltrona e divano a due o più posti. Struttura in acciaio con cinghie elastiche. Gambe in acciaio verniciato colore nero opaco con piedini in materiale termoplastico. Imbottitura in poliuretano espanso a quote differenziate e ovatta di poliestere rivestito con vellutino di poliestere. Cuscini di seduta in piuma d'oca con supporto in poliuretano espanso a quote differenziate rivestito in tela di cotone. Cuscini schienali e cuscini volanti in piuma d'oca rivestita in tela di cotone. Rivestimento sfoderabile in tessuto o fisso in velluto o pelle.

Armchair and two or more-seater sofa. Frame in steel with elastic straps. Legs in matt black coated steel with feet in thermoplastic material. Padding in variable-density polyurethane foam, covered by light polyester velvet. Seat cushions in goose down with support in foamed polyurethane, covered in cotton cloth. Back and loose cushions in goose down, covered in cotton cloth. Removable cover in fabric or non-removable in leather and velvet.

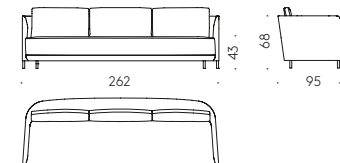
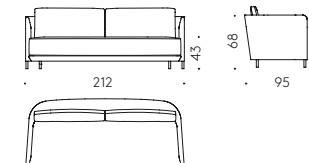
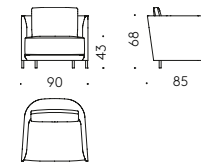

**Poltrone e Divani**  
— Armchairs and Sofas

**Chesterfield 16** — 1983/2016

Divano a due o più posti. Struttura in legno con cinghie elastiche e molle in acciaio armonico. Piedi in frassino tinto all'anilina color carbone o ruote anteriori piroettanti in nylon bianco. Imbottitura in poliuretano espanso a quote differenziate, memory foam e ovatta di poliestere e capitonné su schienale e braccioli. Rivestimento fisso in tessuto o pelle. Opzionale: cuscini volanti in ovatta di poliestere.

Two or more-seater sofa. Frame in wood with elastic straps and springs in spring steel. Feet in Aniline-dyed ash, charcoal coloured, or front swivel castors in white nylon. Padding in variable-density polyurethane foam and memory foam and polyester wadding. Button tufting on back and armrests. Non-removable cover in fabric or in leather. Optional: loose cushions in polyester wadding.

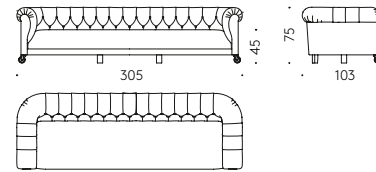
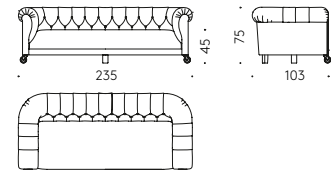
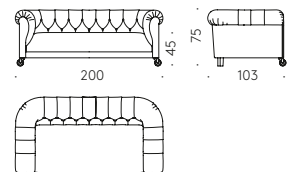
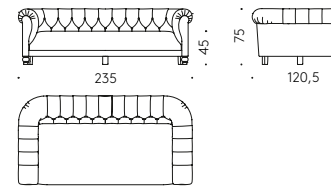
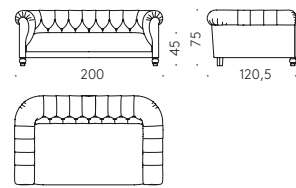
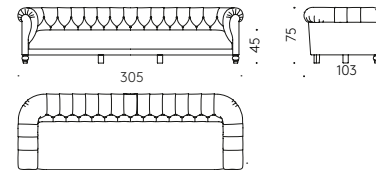
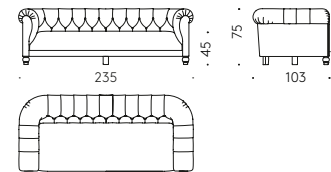
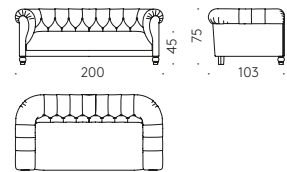

**Chesto** — Patrick Nourget, 2018

Poltrona. Struttura in acciaio con cinghie elastiche. Gambe in massello di frassino tinto sbiancato o tinto color noce canaletto o color nero. Imbottitura in poliuretano espanso a quote differenziate e ovatta di poliestere rivestito con vellutino di poliestere. Rivestimento sfoderabile in tessuto o fisso in velluto o pelle.

Armchair. Frame in steel with elastic straps. Legs in Solid bleached ash wood or Canaletto walnut or black coloured. Padding in variable-density polyurethane foam and polyester wadding, covered by light polyester velvet. Removable cover in fabric or non-removable in velvet or leather.

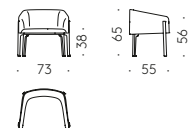

**Combi Pouf** — Piero Lissoni, 2019

Pouf. Struttura in legno, basi in acciaio color nero opaco. Piedini regolabili in metallo. Imbottitura in poliuretano espanso ed ovatta poliestere. Rivestimento fisso in tessuto, velluto o pelle.

Pouf. Frame in wood, bases in steel, painted matt black. Adjustable feet in metal. Polyurethane foam padding and polyester wadding. No-removable cover in fabric, velvet or leather.

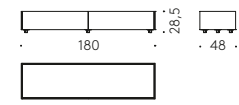
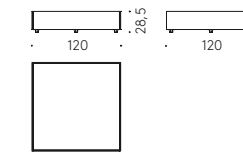
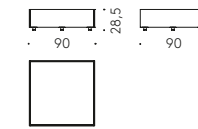
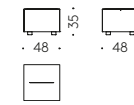
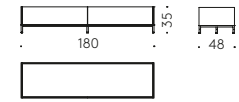
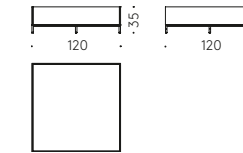
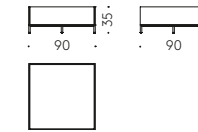
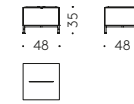

**Erei** — Elisa Ossino, 2018

Divano a due o più posti o componibile. Struttura in legno con cinghie elastiche. Gambe in acciaio verniciato color canna di fucile o color mattone. Piedini in materiale termoplastico. Imbottitura in poliuretano espanso a quote differenziate, memory foam e ovatta di poliestere. Rivestimento sfoderabile in tessuto o fisso in velluto o pelle. Opzionale: cuscini volanti in piuma d'oca rivestita in tela di cotone con rivestimento sfoderabile in tessuto o fisso in velluto o pelle. Cuscini poggiatesta in poliuretano espanso e ovatta di poliestere con rivestimento sfoderabile in tessuto o fisso in velluto o pelle. Tasca per bracciolo in pelle con supporto posteriore antiscivolo.

Two or more-seater sofa or modular sofa. Frame in wood with elastic straps. Legs in coated steel in colour gun barrel grey or brick. Feet in thermoplastic material. Padding in variable-density polyurethane foam, memory foam and polyester wadding, covered by light polyester velvet and cotton cloth. Removable cover in fabric or non-removable in leather or velvet. Optional: loose cushions in goose down, covered with cotton cloth. Removable cover in fabric or non-removable cover in velvet or leather. Headrest cushions in polyurethane foam and polyester wadding with removable cover in cloth or non-removable in velvet or leather. Armrest organiser for accessories in leather with with rear anti-slip strip.

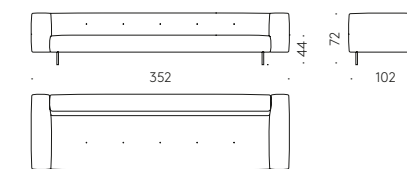
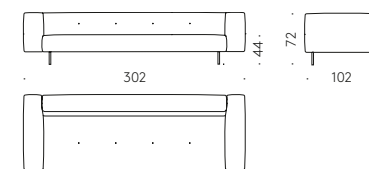
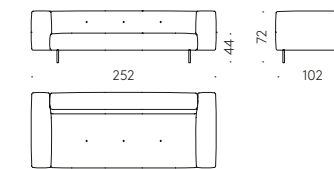
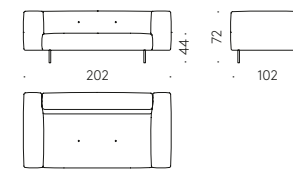

**Poltrone e Divani**  
— **Armchairs and Sofas**

elementi terminali/end elements

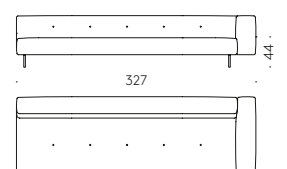
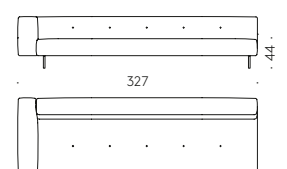
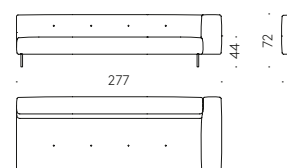
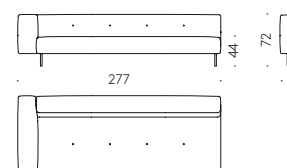
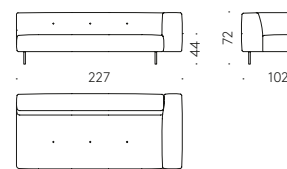
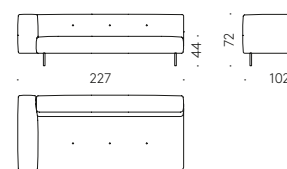
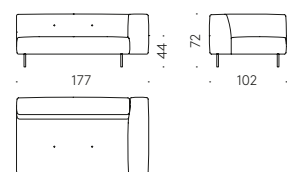
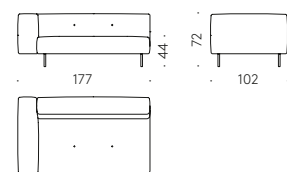

elementi centrali/central elements

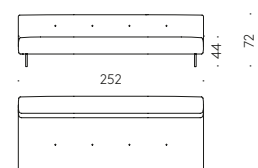
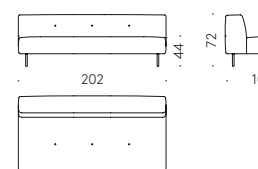
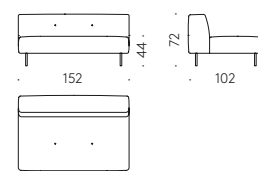

esempi di composizione/compositions

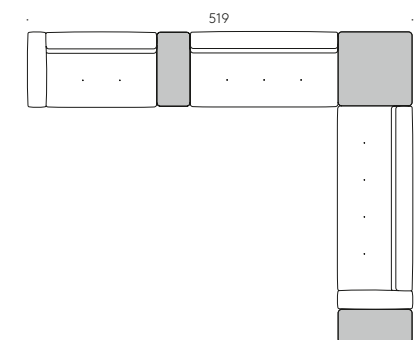
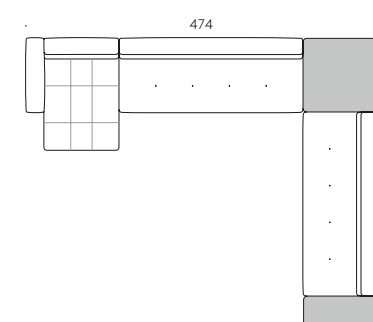
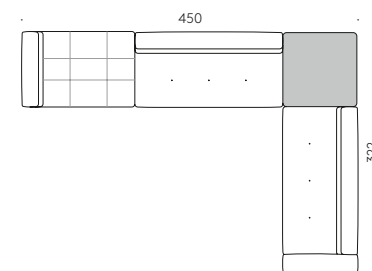
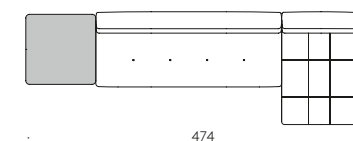
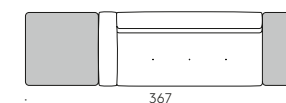
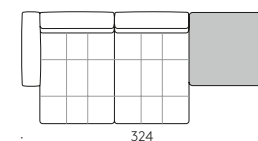

**Erei daybed** — Elisa Ossino, 2019

Daybed. Struttura in legno con cinghie elastiche. Gambe in acciaio verniciato colore canna di fucile o mattone. Piedini in materiale termoplastico. Imbottitura in poliuretano espanso a quote differenziate, memory foam e ovatta di poliestere. Rivestimento sfoderabile in tessuto o fisso in velluto o pelle. Cuscino poggiatesta a rullo in poliuretano espanso e ovatta di poliestere con rivestimento in pelle.

Daybed. Frame in wood elastic straps. Legs in coated steel in colour gun barrel grey or brick. Feet in thermoplastic material. Padding in variable-density polyurethane foam, memory foam and polyester wadding. Removable cover in fabric or non-removable in leather or velvet. Headrest cushion in polyurethane foam and polyester wadding, covered with leather.

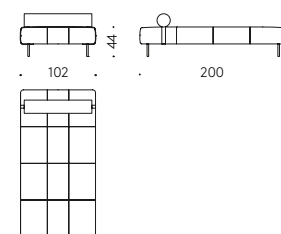

chaise longue

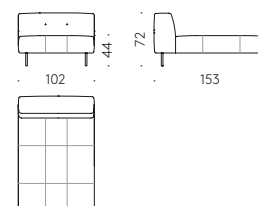
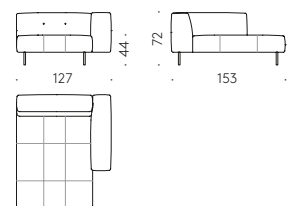
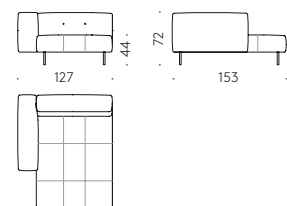

pouf

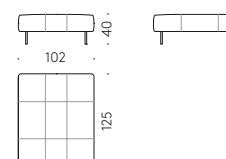
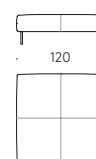
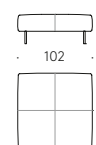

cuscini/cushions



tasca/pocket

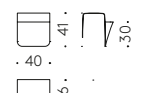

ruolo/roller

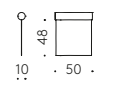

**Poltrone e Divani**  
— Armchairs and Sofas

**Étiquette** — Gamfratesi, 2018

Poltrona, divano a due o più posti, divano componibile, pouf e tavolini. Struttura in acciaio verniciato color nero. Piedi in materiale termoplastico. Elemento orizzontale dello schienale in legno massello di frassino tinto color carbone. Cinghie in cuoio pigmentato colore naturale o marrone. Bracciolo in acciaio, imbottito con poliuretano espanso e rivestito in vellutino di poliestere. Cuscini di seduta in piuma d'oca con supporto in memory foam e poliuretano espanso rivestito con tela di cotone. Cuscini di schienale e bracciolo in piuma d'oca con supporto in poliuretano espanso rivestito con tela di cotone. Rivestimento sfoderabile in tessuto o fisso in velluto o pelle. Tavolini con struttura in acciaio verniciato nero opaco. Top in marmo Bianco Carrara, Calacatta Oro e Grey Stone. Optional: loose cushions in goose down.

Two or more-seater sofa or modular sofa, pouf and small tables. Frame in coated steel, black-coloured. Thermoplastic feet. Horizontal back element in solid aniline-dyed ash wood, charcoal coloured. Straps in pigmented cowhide natural or brown colour. Armrests in steel, padded with polyurethane foam and covered by light polyester velvet. Seat cushion in goose down with memory foam support and polyurethane foam, covered in cotton cloth. Back and armrest cushion in goose down with support in variable-density polyurethane foam, covered with cotton cloth. Removable cover in fabric or non-removable in leather or velvet. Small tables with matt black steel frame. Table top in white Carrara marble, Calacatta Oro and Grey Stone. Optional: loose cushions in goose down.

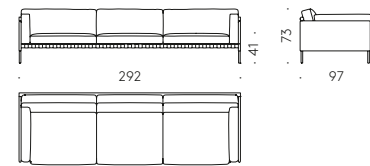
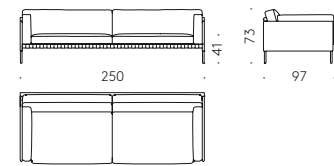
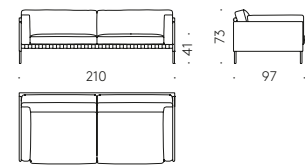
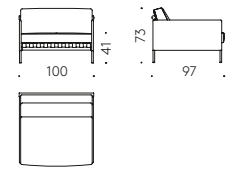
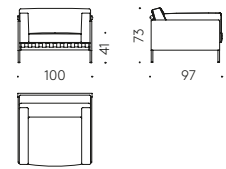

elementi terminali/end elements

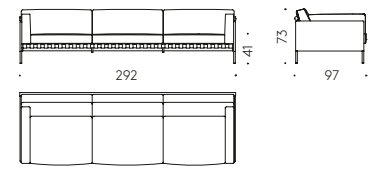
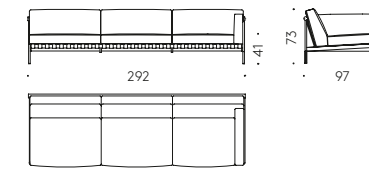
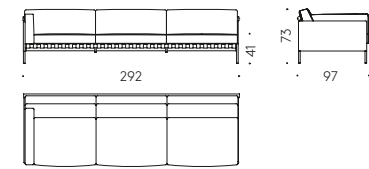
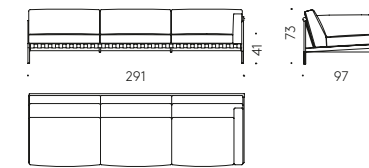
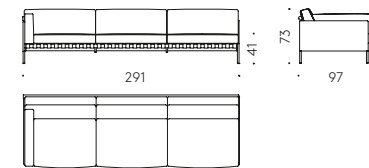
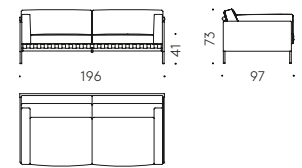
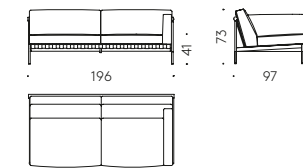
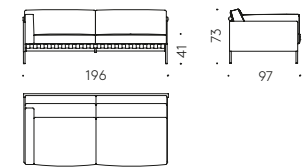
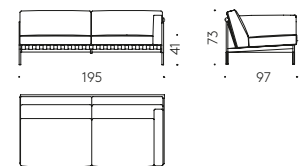
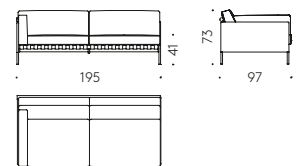
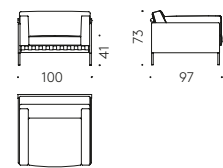
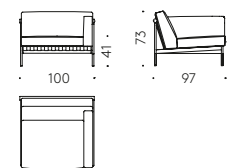
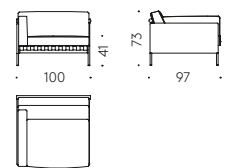
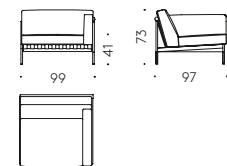
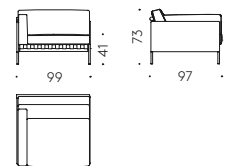

elementi senza braccioli/without armrests elements

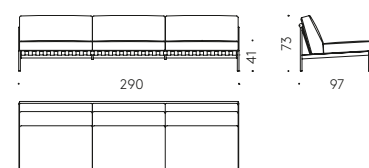
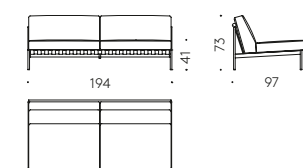
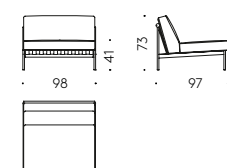
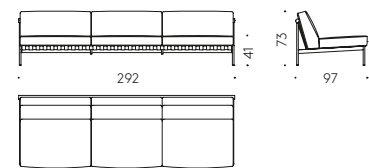
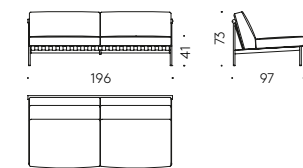
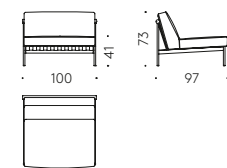
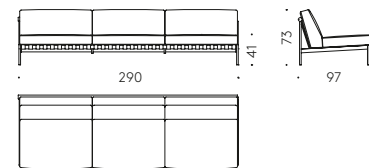
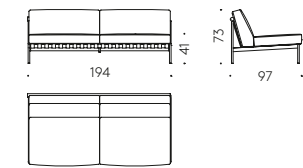
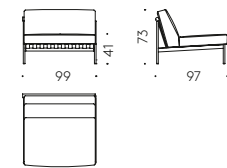
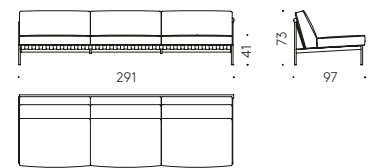
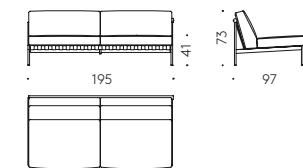
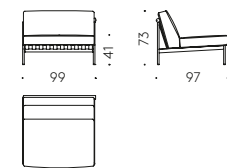



**Poltrone e Divani**  
— **Armchairs and Sofas**

pouf

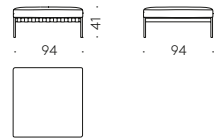

tavolini/tables

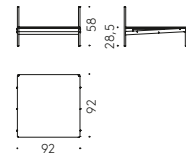
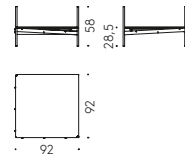
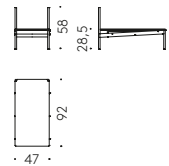

esempi di composizione/compositions

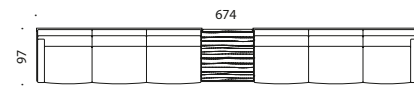
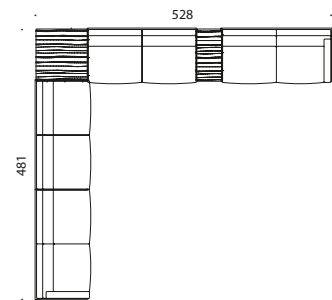
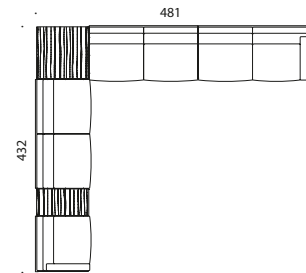
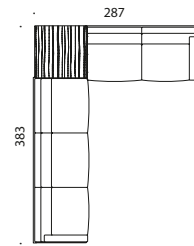

**Flying Landscape** — Piero Lissoni, 2019

Divano a due o più posti, divano componibile con pouf, tavolini e accessori. Struttura in legno e acciaio con cinghie elastiche. Basi in lamiera di acciaio color grigio effetto grezzo e piedini in materiale termoplastico color ottone.

Imbottitura in poliuretano espanso a quote differenziate e ovatta di poliestere. Cuscini di seduta in piuma d'oca con supporto in poliuretano espanso rivestito con tela di cotone. Cuscini di schienale in piuma d'oca mista a fibra di poliestere rivestita con tela di cotone. Rivestimento sfoderabile in tessuto o fiso in velluto o pelle. Optional: Cuscino volante in piuma d'oca mista a fibra di poliestere rivestito con tela di cotone. Cuscino poggiatesta in poliuretano espanso e in ovatta di poliestere, rivestito con vellutino di poliestere. Tavolini con basi in lamiera di acciaio color grigio effetto grezzo e piedini in materiale termoplastico color ottone. Top in legno impiallacciato in rovere affumicato o in marmo Bianco Carrara, Calacatta Oro, Grey Stone, Valentine Grey, Gris du Marais e Pietra d'Avola.

Two or more-seater sofa, modular sofa, pouf low tables and accessories. Frame in wood and steel with elastic straps. Bases in steel sheet grey raw-effect coloured, with thermoplastic feet, brass coloured. Padding in variable-density polyurethane foam and polyester wadding. Seat cushions in goose down with support in polyurethane foam, covered with cotton cloth. Backrests cushions in goose down mixed with polyester fibre, covered in cotton cloth. Removable cover in fabric or non-removable in leather. Optional: loose cushions in goose down mixed with polyester fibres, covered in cotton cloth. Headrest cushion in polyurethane foam and polyester wadding, covered by light polyester velvet. Small tables in steel sheet grey raw-effect coloured, with thermoplastic feet, brass coloured. Top in smoked oak veneer or in white Carrara marble, Calacatta Oro, Grey Stone, Valentine Grey, Gris du Marais and Pietra d'Avola.

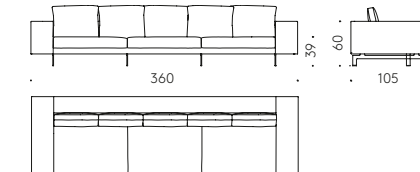
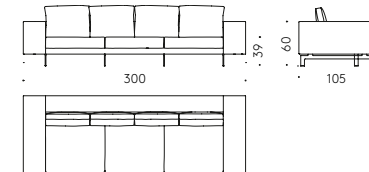
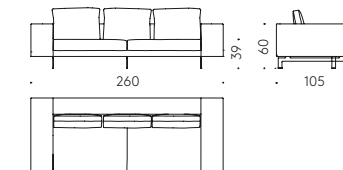
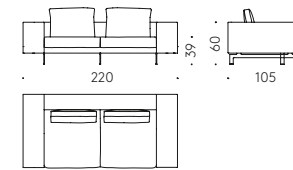

elementi terminali 80/end elements

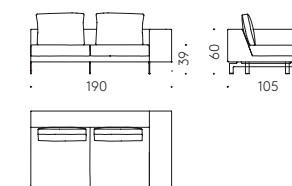
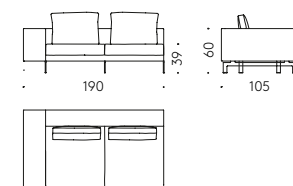
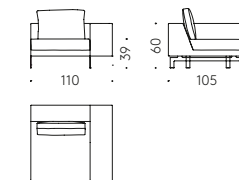
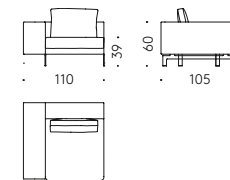

elementi centrali 80/central elements

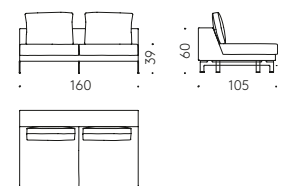
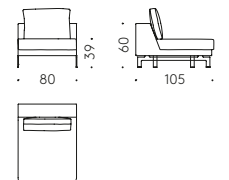

**Poltrone e Divani**  
— Armchairs and Sofas

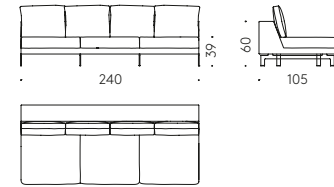
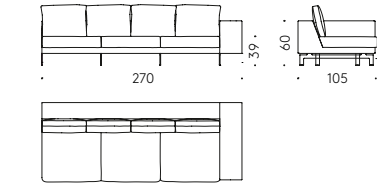
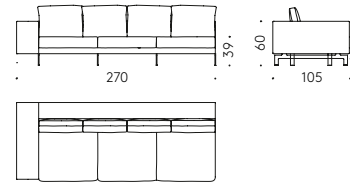

elementi angolari/corner elements

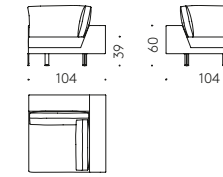
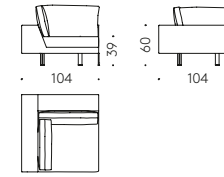

elementi terminali 100/end elements

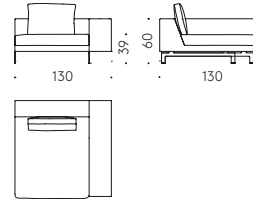
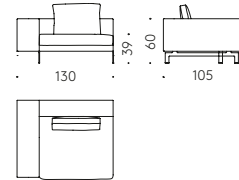

elementi centrali 100/central elements

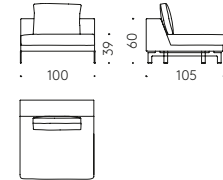

chaise longue

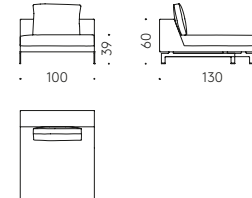
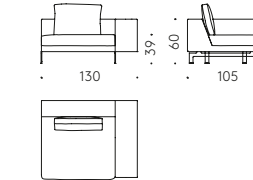
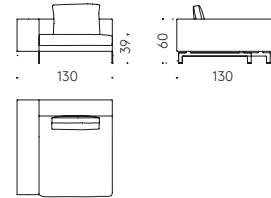
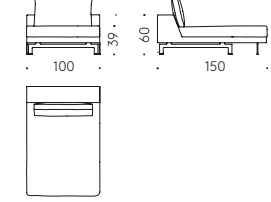
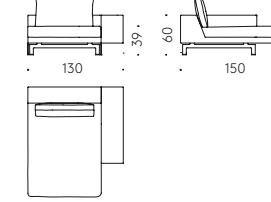
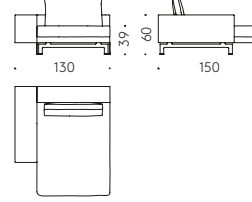

pouf

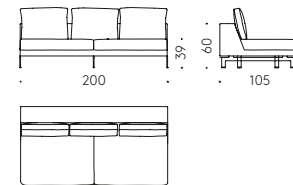
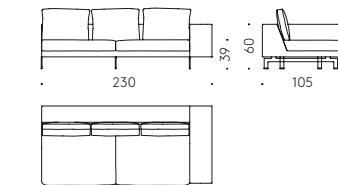
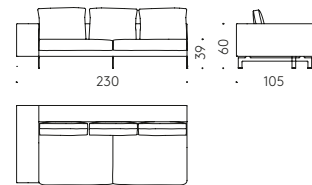
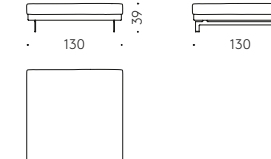
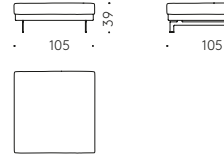

elementi terminali/end elements

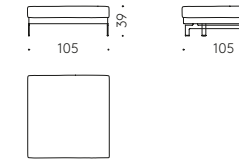
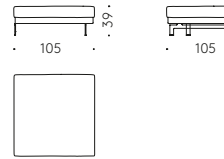

elementi centrali/central elements

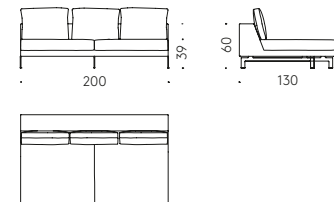
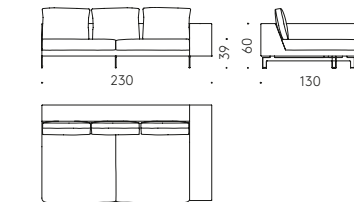
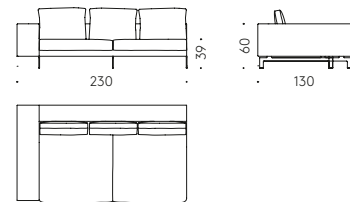
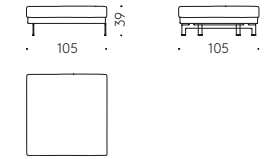

elementi angolari/corner elements

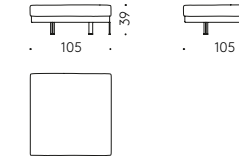
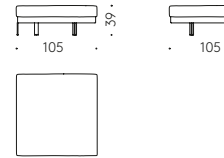

cuscini/cushions

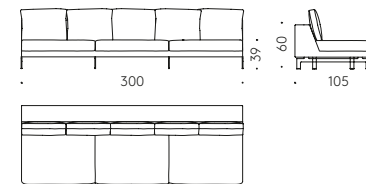
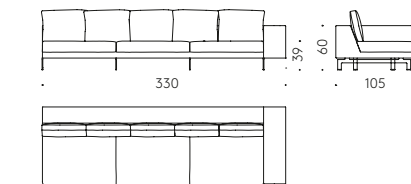
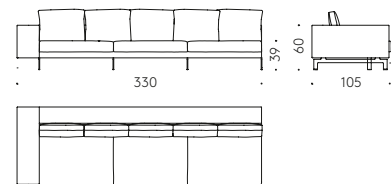

**Poltrone e Divani**  
— **Armchairs and Sofas**

tavolini/tables

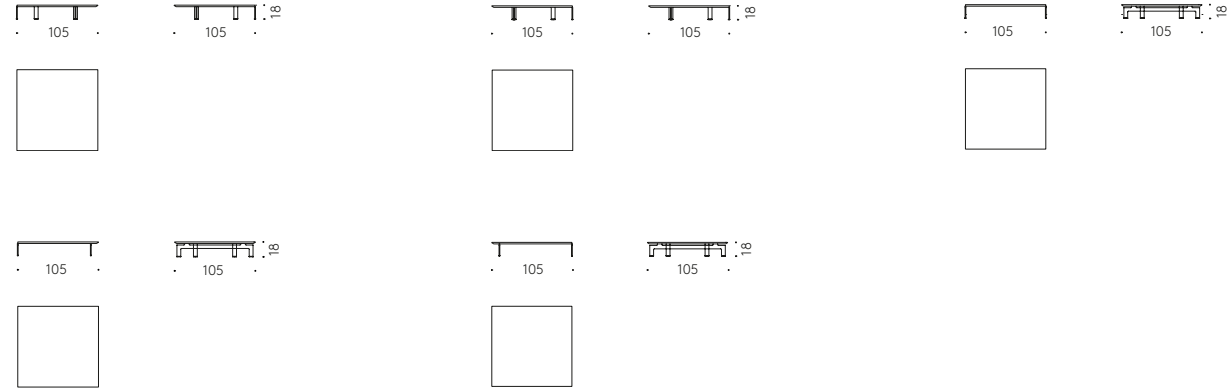

esempi di composizione/compositions

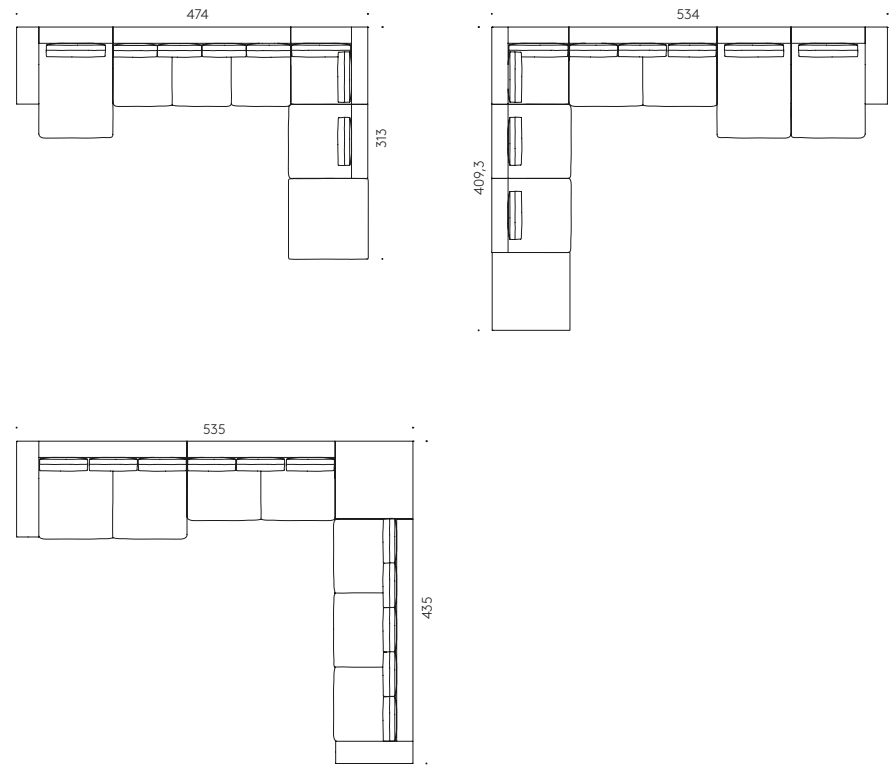

vassoio/tray

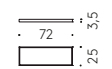

poggiatesta/headrest



**Landscape** — Piero Lissoni, 2016

Divano a due o più posti, divano componibile, pouf e accessori. Struttura in legno con cinghie elastiche. Basi in lamiera di acciaio color grigio effetto grezzo con piedini in materiale termoplastico color ottone. Imbottitura in poliuretano espanso a quote differenziate e ovatta di poliestere. Cuscini di seduta in piuma d'oca con supporto in poliuretano espanso rivestito con tela di cotone. Cuscini di schienale in piuma d'oca mista a fibra di poliestere rivestita con tela di cotone. Rivestimento sfoderabile in tessuto o fisso in pelle. Opzionale: cuscini volanti in piuma d'oca mista a fibra di poliestere rivestito con tela di cotone. Cuscino poggiatesta in poliuretano espanso e ovatta di poliestere, rivestito con vellutino di poliestere. Vassoio in MDF impiallacciato in rovere affumicato.

Two or more-seater sofa, modular sofa, pouf and accessories. Frame in wood with elastic straps. Bases in steel sheet grey raw-effect coloured, with thermoplastic feet, brass coloured. Padding in variable-density polyurethane foam and polyester wadding. Seat cushions in goose down with support in polyurethane foam, covered with cotton cloth. Backrests cushions in goose down mixed with polyester fibre, covered in cotton cloth. Removable cover in fabric or non-removable in leather. Optional: loose cushions in goose down mixed with polyester fibres, covered in cotton cloth. Headrest cushion in polyurethane foam and polyester wadding, covered by light polyester velvet. Tray in MDF veneered with smoked oak.

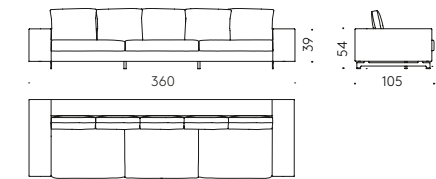
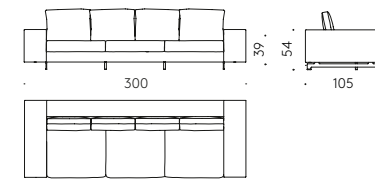
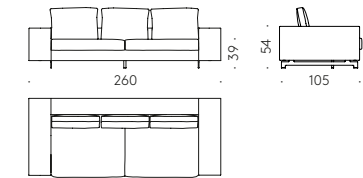
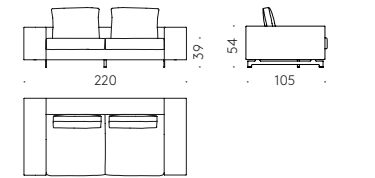

elementi terminali 80/end elements

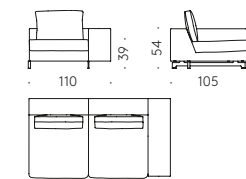
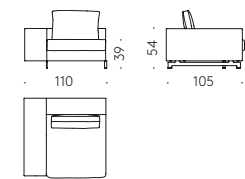

elementi centrali 80/central elements

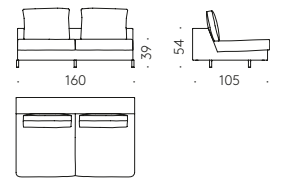
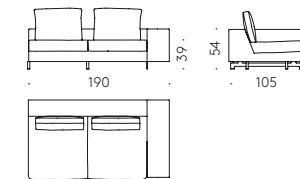
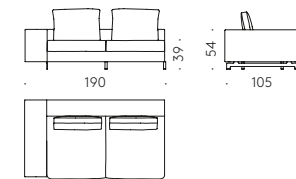
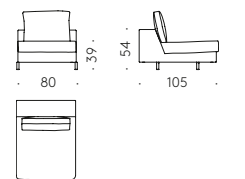

**Poltrone e Divani**  
— Armchairs and Sofas

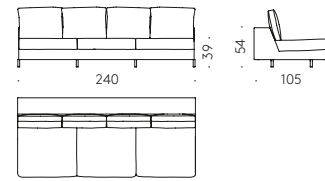
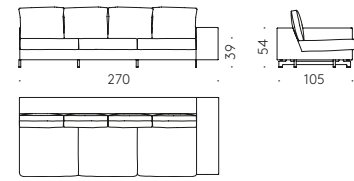
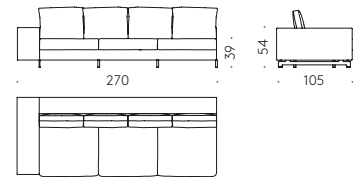

elementi terminali 100/end elements

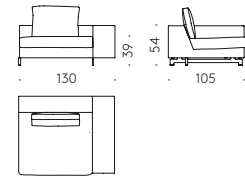
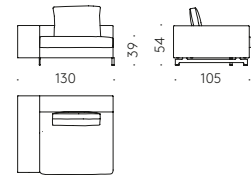

elementi centrali 100/central elements

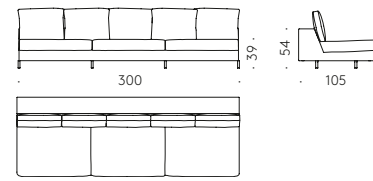
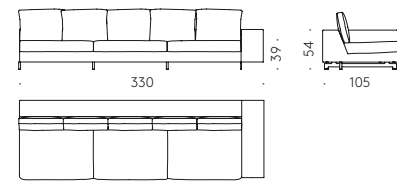
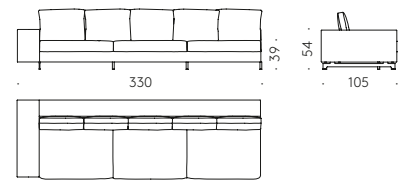
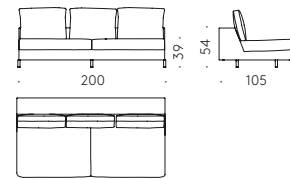
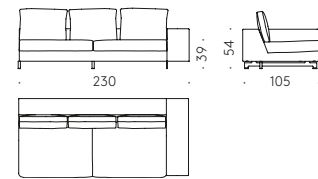
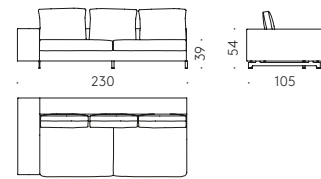
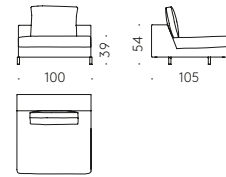

elementi angolari/corner elements

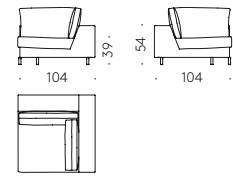
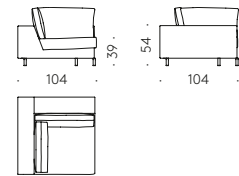

chaise longue

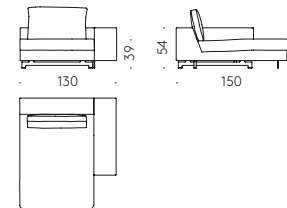
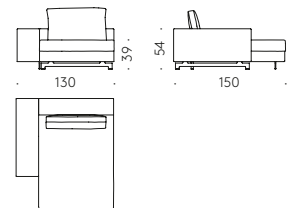

pouf

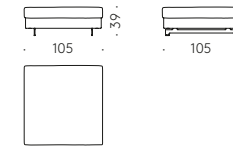

cuscini/cushions



vassoio/tray

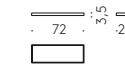

poggiatesta/headrest

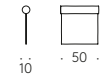

esempi di composizione/compositions

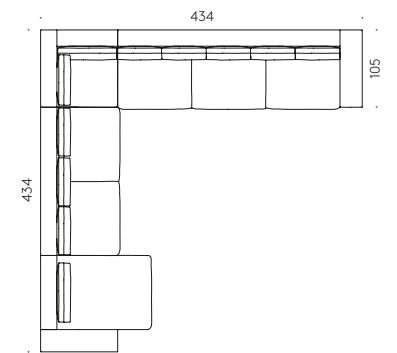
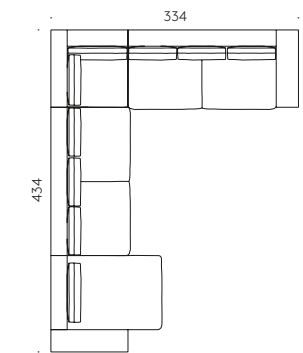
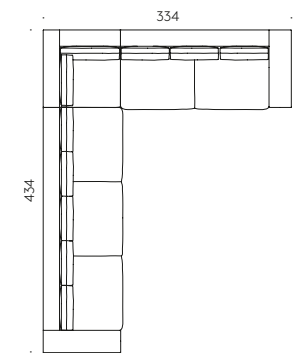
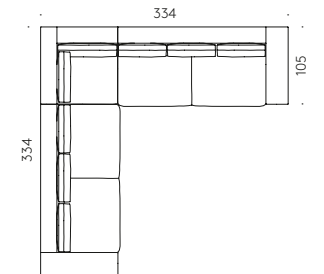
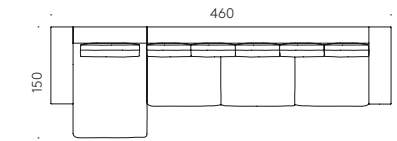

**LC03 Low Chair** — Maarten Van Severen, 2003 — Edizioni De Padova

Poltroncina. Struttura in acciaio verniciato color nero opaco. Piedini in materiale termoplastico. Scocca in resina poliester con fibre di vetro color nero opaco. Imbottitura in poliuretano espanso e ovatta di poliestere, rivestito con tela di cotone. Rivestimento completamente sfoderabile in tessuto o pelle.

Small armchair. Frame in steel, matt black coated. Thermoplastic feet. Body in polyester resin with fibreglass, matt black coloured. Padding in polyurethane foam and polyester wadding covered with cotton cloth. Removable cover in fabric or leather.

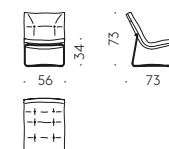

**Poltrone e Divani**  
— Armchairs and Sofas

**LL04 Leather Lounge Chair** — Maarten Van Severen, 2004 — *Edizioni De Padova*

Chaise longue. Struttura in acciaio inox spazzolato fine. Piedini in materiale termoplastico. Scocca in cuoio pieno fiore color naturale o nero. Cucito a mano e fissato con viti in acciaio inox.

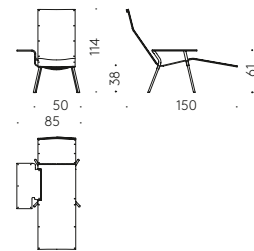

Chaise longue. Frame in fine brushed stainless steel. Thermoplastic feet. Body in full-grain cowhide, natural or black coloured. Hand-stitched and attached to the frame with stainless steel screws.

**Louisiana** — Vico Magistretti con Centro Design Binfaré, 1993

Poltrona con pouf. Struttura in acciaio con cinghie elastiche. Scocca esterna in cuoio pieno fiore. Piedini in acciaio verniciato con ruote piroettanti di cui una frenata. Imbottitura in poliuretano espanso a quote differenziate e ovatta di poliestere rivestito con vellutino di poliestere. Cuscino di seduta in piuma d'oca con supporto in poliuretano espanso rivestito con tela di cotone. Cuscino poggiatesta in piuma d'oca rivestita con tela di cotone. Rivestimento in pelle o in tessuto completamente sfoderabile tramite cerniera zip. Pouf. Struttura in poliuretano rigido montato su ruote piroettanti di cui una frenata. Imbottitura in poliuretano espanso rivestito con vellutino di poliestere. Cuscino di seduta in piuma d'oca con supporto in poliuretano espanso rivestito con tela di cotone. Rivestimento sfoderabile in tessuto o in pelle.

Armchair with pouf. Frame in steel with elastic straps. Feet in coated steel with swivel castors, including one braking device. External body in full-grain cowhide. Padding in variable-density polyurethane foam and polyester wadding, covered by light polyester velvet. Seat cushion in goose down with support in polyurethane foam covered with cotton cloth. Lumbar support cushion in goose down covered with cotton cloth. Internal cover in leather or fabric, totally removable with zipper. Pouf. Rigid polyurethane body with swivel castors, including one braking device. Padding in polyurethane foam, covered by light polyester velvet. Seat cushion in goose down with support in polyurethane foam covered with cotton cloth. Removable cover in fabric or leather.

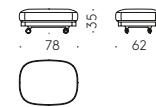
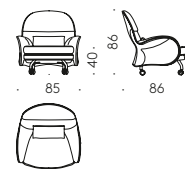

**Margherita** — Piero Lissoni, 2017

Poltrona. Struttura in massello di frassino sbiancato o tinto color nero. Sedile in multistrato di betulla con cinghie elastiche, imbottito in poliuretano espanso e ovatta di poliestere con rivestimento fisso in tessuto o in pelle, oppure sedile in corda di carta naturale intrecciata a mano. Optional: Cuscino di seduta in poliuretano espanso e ovatta di poliestere, rivestito con vellutino di poliestere, con superficie antiscivolo sul lato inferiore. Cuscino volante in piuma d'oca mista a fibra di poliestere e a particelle di poliuretano espanso, rivestita con tela di cotone. Cuscino di schienale in poliuretano espanso e ovatta di poliestere, rivestito con vellutino di poliestere. Rivestimento sfoderabile in tessuto o in pelle.

Armchair. Seat in frame in solid ash wood, bleached or black. Multi-ply birch with elastic straps, padded with polyurethane foam and polyester wadding, non removable cover in fabric or leather, or hand-woven natural paper rope seat. Optional: Seat cushion in polyurethane foam and polyester wadding, covered with light polyester velvet. Anti-slip lower surface. Loose cushion in goose down mixed with polyester fibre and polyurethane foam particles, covered with cotton cloth. Backrest cushion in polyurethane foam and polyester wadding, covered with light polyester velvet. Removable cover in fabric or leather.

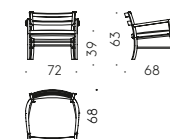
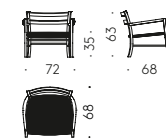

cuscini/cushions

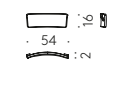

**Mosaïque** — Piero Lissoni, 2017

Divano a due o più posti o componibile con pouf e mobili. Struttura in legno con cinghie elastiche. Piedini in materiale termoplastico. Imbottitura in poliuretano espanso a quote differenziate e ovatta di poliestere, rivestito con vellutino di poliestere. Cuscini di seduta in piuma d'oca con supporto in poliuretano espanso rivestito con tela di cotone. Cuscini di schienale in piuma d'oca mista a poliestere e poliuretano espanso, rivestita con tela di cotone. Poggiatesta in poliuretano espanso rivestito in ovatta di poliestere. Rivestimento sfoderabile in tessuto o fisso in velluto o pelle. Optional: cuscini volanti in piuma d'oca mista poliestere e poliuretano espanso, rivestita con tela di cotone. Cuscino zavorrato con zavorra in acciaio e imbottitura in poliuretano espanso con ovatta di poliestere, rivestito con vellutino di poliestere. Mobili in pannelli di particelle di pioppo rivestiti in rovere affumicato. Top in pannello di particelle di pioppo rivestito in rovere affumicato, o accoppiato con lamiera di ottone striato, acciaio striato grigio o acciaio delabré scuro, o in marmo Grey Stone o Bianco Carrara.

Two or more-seater sofa or modular sofa with pouf and units. Frame in wood elastic straps. Feet in thermoplastic material. Padding in variable-density polyurethane foam and polyester wadding, covered with light polyester velvet. Seat cushions in goose down with support in polyurethane foam, covered with cotton cloth. Backrests cushions in goose down mixed with polyester and polyurethane foam, covered in cotton cloth. Headrest in polyurethane foam covered with polyester wadding. Removable cover in fabric or non-removable in leather. Optional: loose cushions in goose down mixed with polyester and polyurethane foam, covered in cotton cloth. Weighted cushion with ballast in steel and padding in polyurethane foam and polyester wadding, covered by light polyester velvet. Units in poplar particle board panel covered with smoked oak. Top in panel in poplar particle covered with smoked oak or matched with striped brass sheet, striped grey steel or dark delabré steel, or Greystone marble or white Carrara marble.

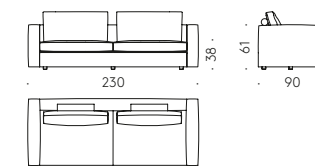
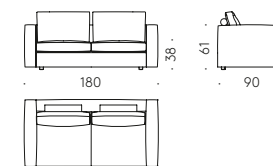



**Poltrone e Divani**  
**— Armchairs and Sofas**

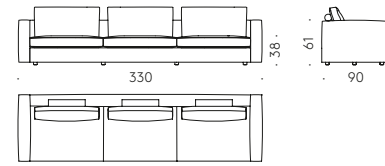
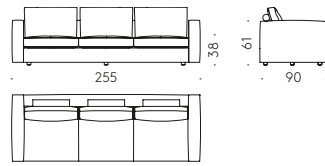

**elementi terminali/end elements**

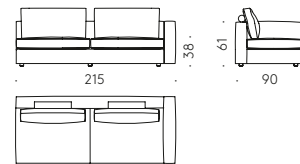
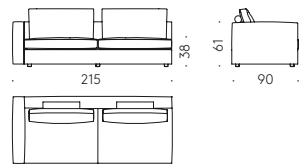
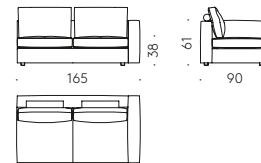
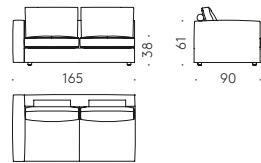
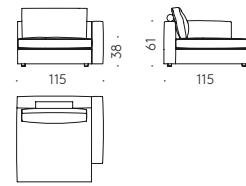
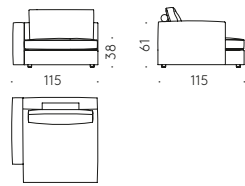
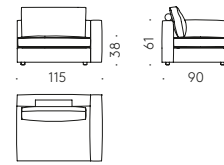
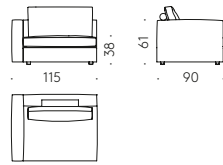
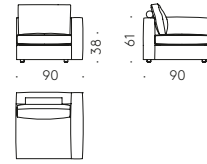
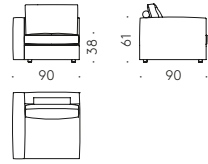

**elementi centrali/central elements**

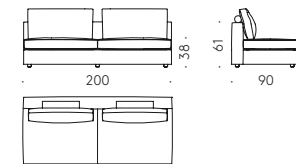
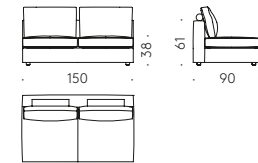
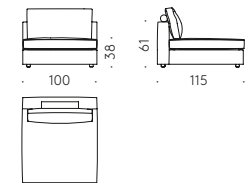
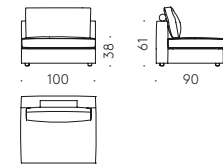
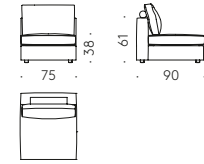

**elementi angolari/corner elements**

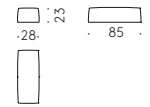
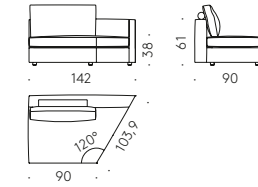
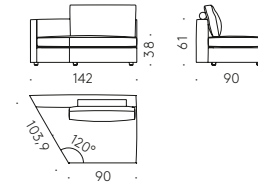

**elementi a penisola/peninsular elements**

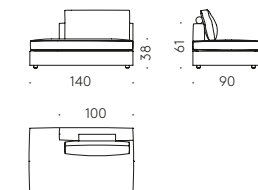
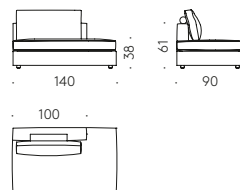
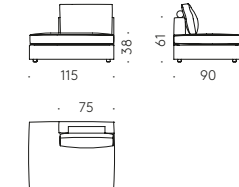
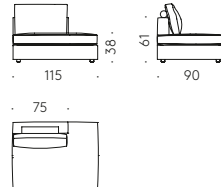

**elementi angolari/corner elements**

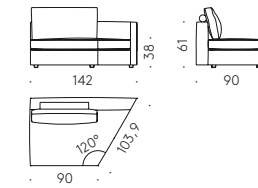
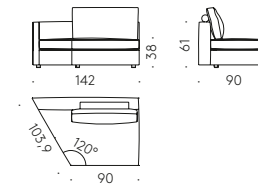

**chaise longue**

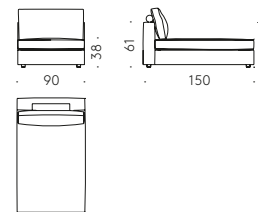
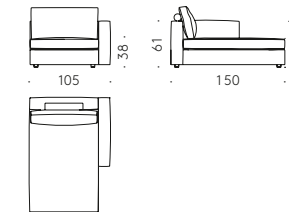
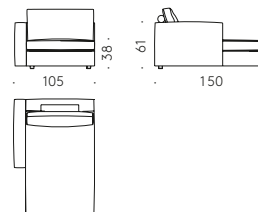

**elementi braccioli basso/low armrest elements**

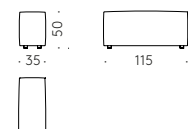
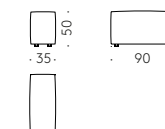
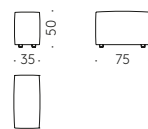

**Poltrone e Divani**  
— **Armchairs and Sofas**

**pouf**

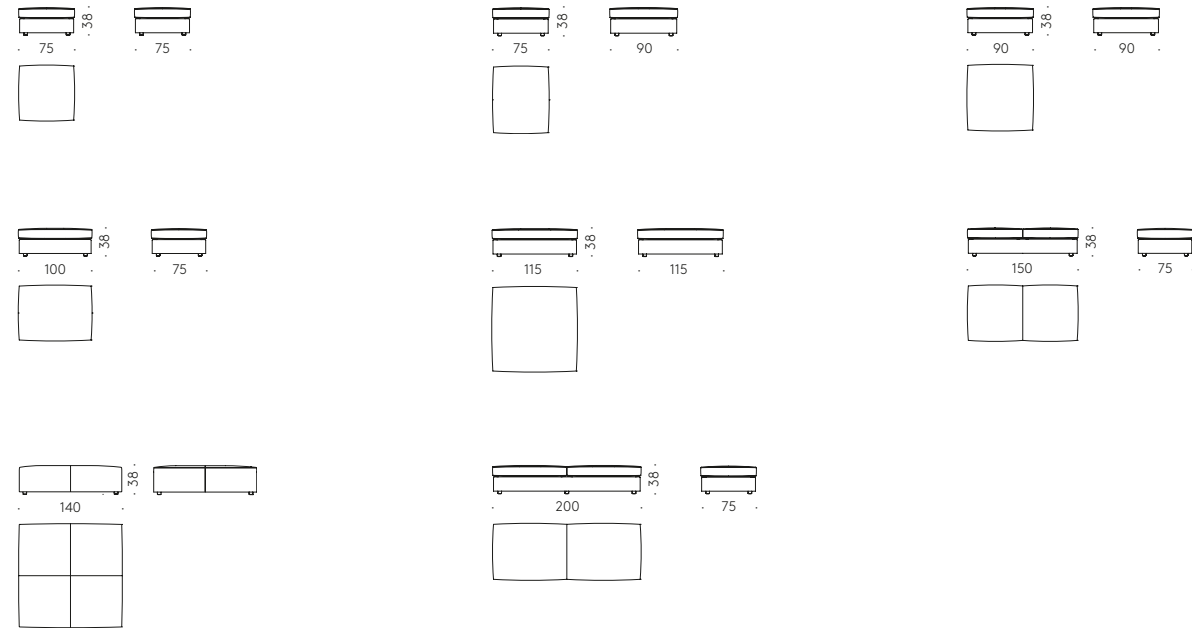

**cuscini/cushions**



**cuscini con poggiatesta/headrest cushions**



**cusciino zavorrato/weighted cushions**

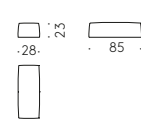

**mobili/furniture**

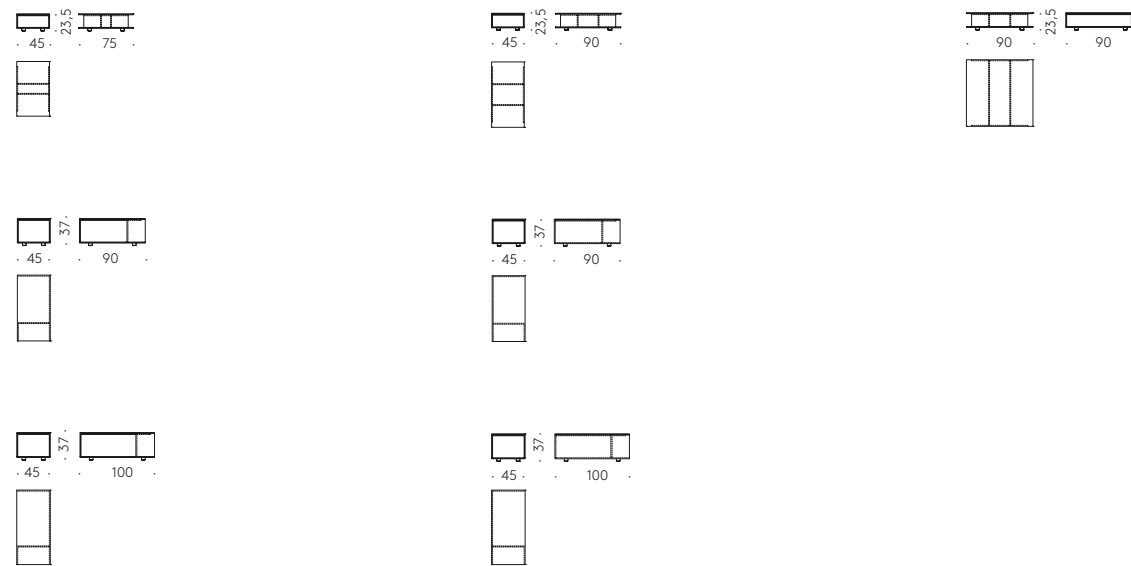

**esempi di composizione/compositions**

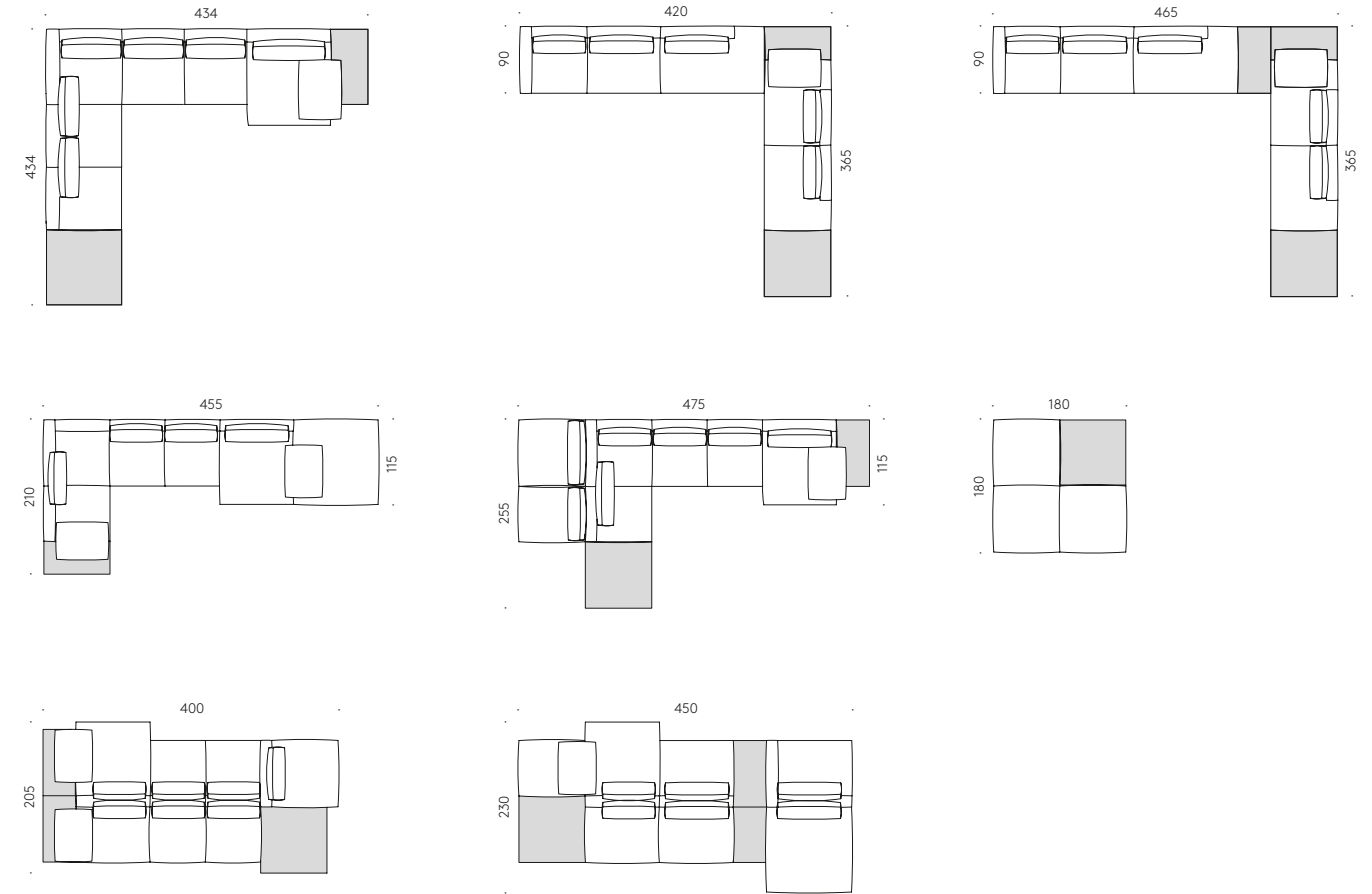

**Pillow** — Vico Magistretti, 2004

Divano a due o più posti e divano componibile. Struttura in acciaio e legno con cinghie elastiche. Piedini regolabili in acciaio e materiale termoplastico. Imbottitura in poliuretano espanso a quote differenziate e ovatta di poliestere rivestito con vellutino di poliestere e tela di cotone. Cuscino di seduta e cuscino schienale in piuma d'oca mista a particelle di poliuretano espanso rivestito con tela di cotone. Cuscini volanti in piuma d'oca rivestiti con tela di cotone. Rivestimento sfoderabile in tessuto o fisso in velluto.

Two or more-seater sofa and modular sofa. Frame in steel and thermoplastic and wood with elastic straps. Adjustable thermoplastic feet. Padding in variable-density polyurethane foam and polyester wadding, covered with light polyester velvet and cotton cloth. Seat cushions and back cushions in goose down mixed with particles of polyurethane foam covered with cotton cloth. Loose cushions in goose down covered with cotton cloth. Removable cover in fabric or non-removable in velvet.

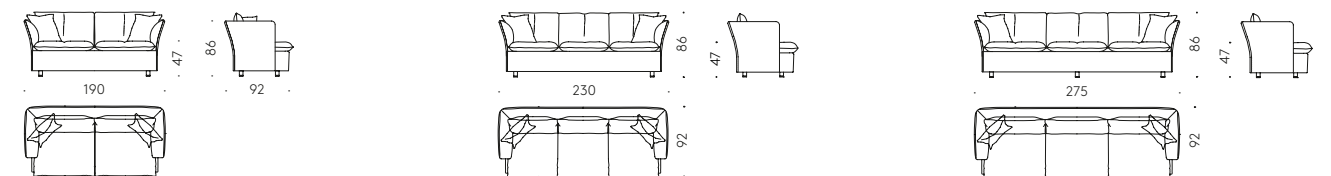

**Poltrone e Divani**  
— **Armchairs and Sofas**

elementi terminali/end elements

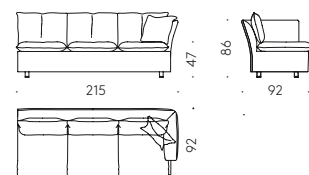
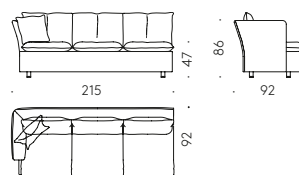
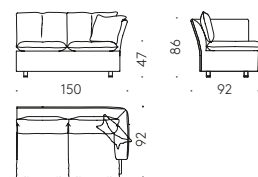
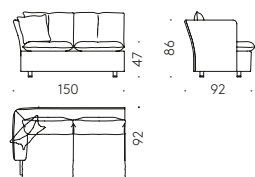

elementi angolari/corner elements

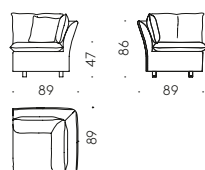

chaise longue

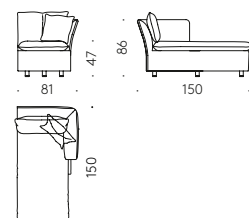
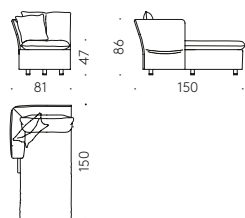

cuscini/cushions



esempi di composizione/compositions

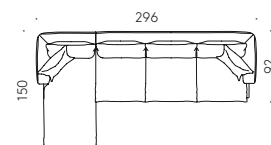
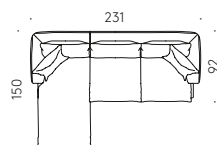

elementi centrali/central elements

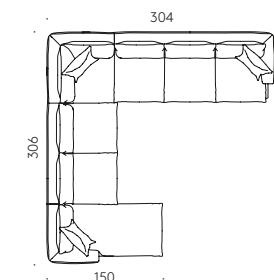
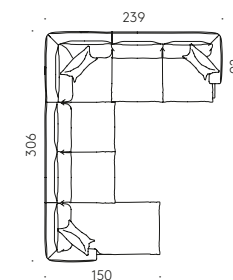
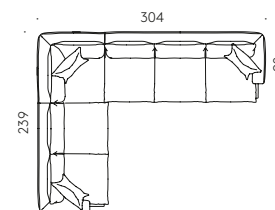
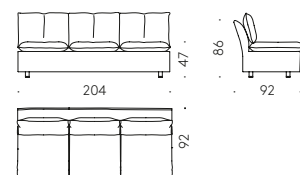
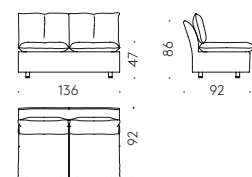

**Pillow 19** — Vico Magistretti 2004, 2019

Divano a due o più posti o componibile con cuscini differenziati dimensionalmente. Struttura in acciaio e legno con cinghie elastiche. Piedini in materiale termoplastico. Imbottitura in poliuretano espanso a quote differenziate e ovatta di poliestere rivestiti con vellutino di poliestere e tela di cotone. Cuscino di seduta in piuma d'oca mista a poliuretano espanso con inserto in poliuretano espanso. Cuscino di schienale in piuma d'oca mista a particelle di poliuretano espanso rivestito con tela di cotone. Cuscino volante in piuma d'oca rivestito con tela di cotone. Rivestimento sfoderabile in tessuto o fisso in velluto.

Two or more-seater sofa and modular sofa with dimensionally differentiated cushions. Frame in steel and wood with elastic straps. Adjustable thermoplastic feet. Padding in variable-density polyurethane foam and polyester wadding, covered by light polyester velvet and cotton cloth. Seat cushion in goose down with polyurethane foam insert. Backrest cushion in goose down mixed with polyurethane foam particles, covered with cotton cloth. Loose cushion in goose down covered with cotton cloth. Removable cover in fabric or non-removable in velvet.

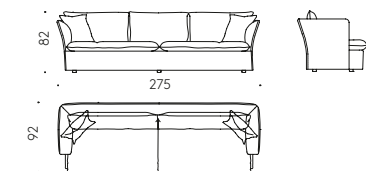
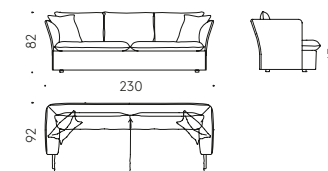
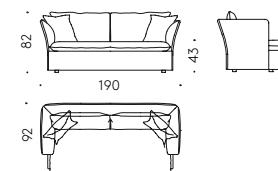

**Pilotis** — Philippe Nigro, 2012

Poltrona, pouf e divano a due o più posti. Struttura in acciaio e legno. Gambe in massello di rovere naturale o noce canaletto. Piedini regolabili in materiale termoplastico. Imbottitura in poliuretano espanso a quote differenziate e ovatta di poliestere rivestito con vellutino di poliestere. Cuscino di seduta in piuma d'oca con supporto in poliuretano espanso a quote differenziate rivestito in tela di cotone. Cuscinetto poggiatesta in ovatta di poliestere, rivestito in tela di cotone. Rivestimento sfoderabile in tessuto o fisso in pelle o velluto.

Armchair, pouf and two or more-seater sofa. Frame in steel and wood. Legs in solid natural oak or Canaletto walnut. Adjustable thermoplastic feet. Padding in variable-density polyurethane foam and polyester wadding, covered by light polyester velvet. Seat cushion in goose down with support in variable-density polyurethane foam, covered with cotton cloth. Lumbar support cushion in polyester wadding covered in cotton cloth. Removable cover in fabric or non-removable in velvet or leather.

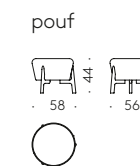
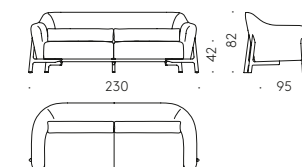
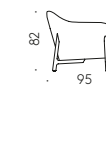
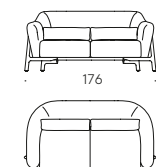
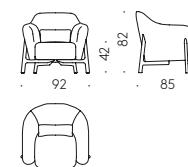

**Poltrone e Divani**  
— **Armchairs and Sofas**

**Pouf Capitonné** — 2004

Pouf. Struttura in legno con imbottitura in poliuretano espanso. Rivestimento capitonné fisso in tessuto o in pelle.

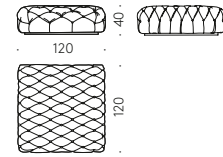

Pouf. Frame in wood with padding in polyurethane foam. Non-removable button-tufted fabric or leather cover.

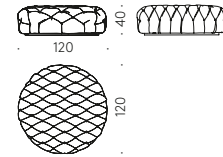
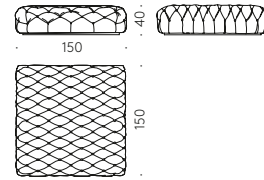

**Raffles** — Vico Magistretti, 1988

Poltrona, pouf e divano a due o più posti. Struttura in legno con cinghie elastiche. Piedini anteriori in faggio tinto all'anilina color noce con ruota\*. Piedini posteriori e centrale in massello di faggio regolabili. Imbottitura in poliuretano espanso a quote differenziate e ovatta di poliestere rivestito con vellutino di poliestere e tela di cotone. Due versioni di cuscini di seduta: con piuma d'oca rivestita con tela di cotone o con memory foam (poliuretano espanso e ovatta di poliestere, rivestiti con tela di cotone). Rivestimento sfoderabile in tessuto o fisso in velluto. \*senza ruote nella versione da 3 metri.

Armchair, pouf and two or more-seater sofa. Frame in wood with elastic straps. front feet in aniline-dyed beechwood, walnut stained, with castor\*. Adjustable rear and central feet in solid beechwood. Padding in variable-density polyurethane foam and polyester wadding, covered by light polyester velvet and cotton cloth. Two typologies of seat cushions: in goose down covered with cotton cloth or memory foam (polyurethane foam and polyester wadding covered in cotton cloth). Removable cover in fabric or non-removable in velvet. \*without castors in the 3 mt version.

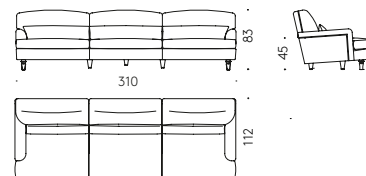
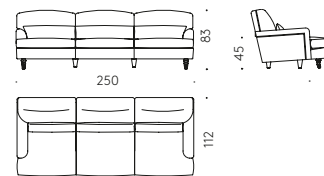
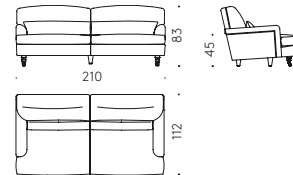
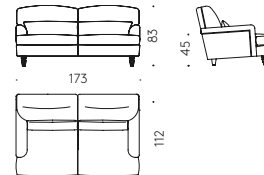
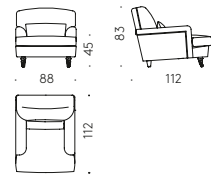

**pouf**

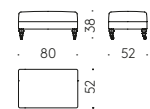

**Regent's** — 1983/2016

Poltrona, pouf e divano a due o più posti. Struttura in legno con cinghie elastiche. Gambe in faggio con piedini regolabili in materiale termoplastico. Imbottitura in poliuretano espanso a quote differenziate e ovatta di poliestere rivestito con vellutino di poliestere. Cuscino di seduta in piuma d'oca con supporto in poliuretano espanso rivestito con tela di cotone. Rivestimento sfoderabile in tessuto.

Armchair, pouf and two or more-seater sofa. Frame in wood with elastic straps. Legs in beechwood with adjustable thermoplastic feet. Padding in variable-density polyurethane foam and polyester wadding, covered by light polyester velvet. Seat cushion in goose down with support in polyurethane foam, covered with cotton cloth. Removable cover in fabric.

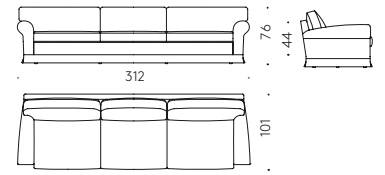
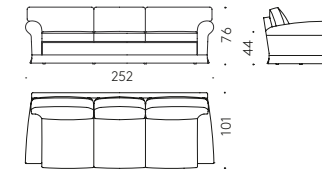
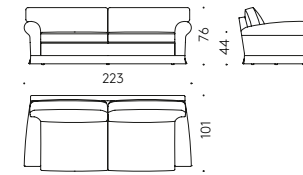
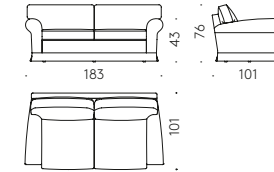
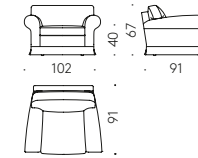

**pouf**

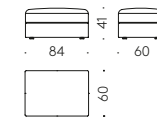

**Silvia** — Paolo Tilche/Archivio Storico Bonacina 1889, 1960 — Edizioni De Padova

Poltrona. Poltrona in giunco con base in Manila e struttura in Malacca con armatura in canna d'India e lagature in corteccia di giunco, qualità extra superiore. Piedini in termoplastica. Opzionale: cuscino sagomato in poliuretano espanso e ovatta di poliestere, rivestito con vellutino di poliestere. Nella parte inferiore è applicata una superficie antiscivolo. Rivestimento sfoderabile in tessuto o pelle.

Armchair. Seat in rattan, base in Manila and frame in Malacca with armour in Indian cane and bindings in extra-quality rattan skin threads. Thermoplastic feet. Optional: shaped cushion in polyurethane foam and polyester wadding, covered by light polyester velvet. A non-slip surface is applied in the lower part. Removable cover in fabric or leather.

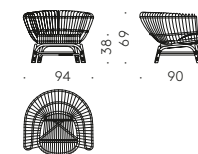

**cuscini/cushions**

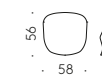

**Poltrone e Divani**  
— Armchairs and Sofas

**Smeralda** — Anna von Schewen, 2014

Poltrona, divanetto a due posti e pouf. Struttura in acciaio verniciato color grigio antracite. Piedini in termoplastica. Seduta con telaio in acciaio e cinghie elastiche, imbottita in poliuretano espanso e ovatta di poliestere, rivestito con vellutino di poliestere. Schienale e braccioli con struttura in poliuretano rigido, imbottito in poliuretano espanso e ovatta di poliestere rivestito con vellutino di poliestere. Rivestimento sfoderabile in tessuto.

Armchair, two-seater sofa and pouf. Frame in stainless steel, antrachite-grey coloured. Thermoplastic feet. Seat in steel with elastic straps. Padding in polyurethane foam and polyester wadding, covered by light polyester velvet. Backrest and armrests with frame in rigid polyurethane, padded with polyurethane foam and polyester wadding covered with light polyester velvet. Removable cover in fabric.

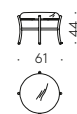
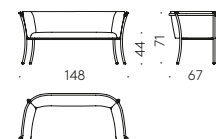
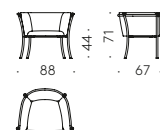

**Square 16** — 2004/2016

Divano a due o più posti e divano componibile. Struttura in acciaio e legno con cinghie elastiche. Gambe in Acciaio verniciato color canna di fucile con piedini regolabili in materiale termoplastico. Imbottitura in poliuretano espanso a quote differenziate e ovatta di poliestere rivestito con vellutino di poliestere. Cuscini di schienale in piuma d'oca mista a fibra di poliestere rivestita con tela di cotone. Cuscino e bracciolo in piuma d'oca con supporto in poliuretano espanso rivestito con tela di cotone. Rivestimento sfoderabile in tessuto o fisso in velluto o pelle.

Two or more-seater sofa and modular sofa. Frame in steel and wood with elastic straps. Legs in coated steel, gunbarrel grey coloured, with adjustable thermoplastic feet. Padding in variable-density polyurethane foam and polyester wadding, covered by light polyester velvet. Backerest cushion in goose down mixed with polyurethane foam particles, covered with cotton cloth. Seat and armrest cushion in goose down with support in polyurethane foam, covered with cotton cloth. Removable cover in fabric or non-removable in leather or velvet.

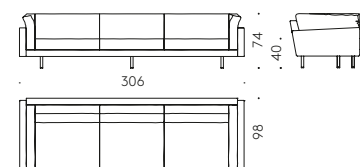
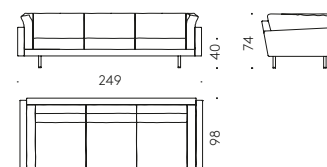
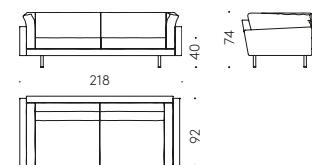
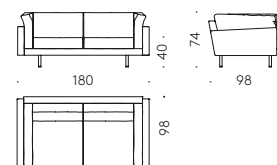

elementi terminali/end elements

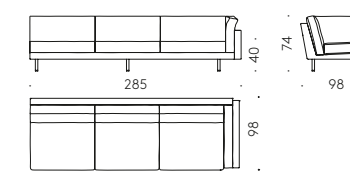
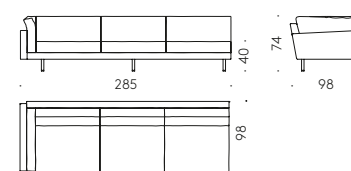
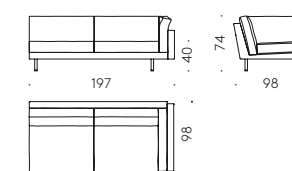
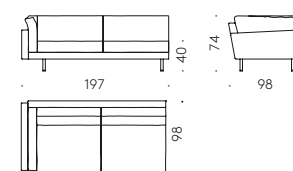
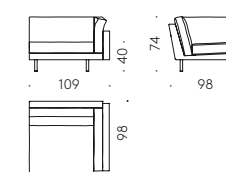
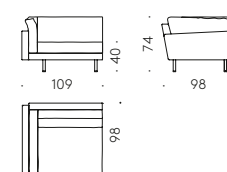

elementi centrali/central elements

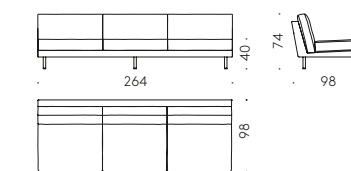
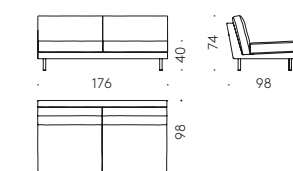
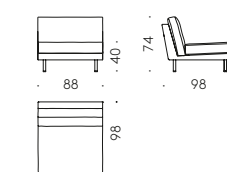

elementi angolari/corner elements

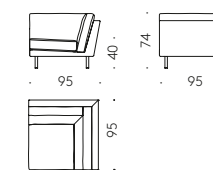
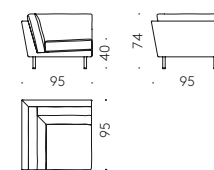

chaise longue

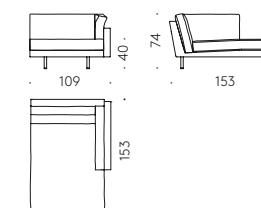
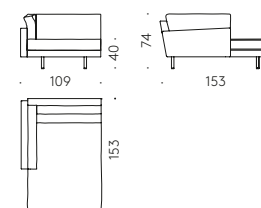

esempi di composizione/compositions

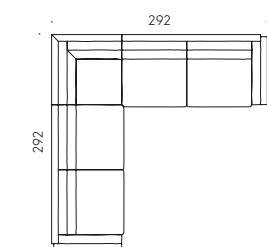
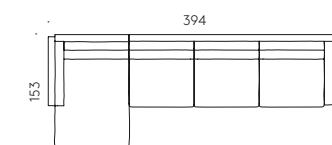
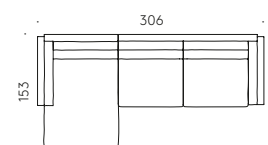



**Poltrone e Divani**  
— Armchairs and Sofas

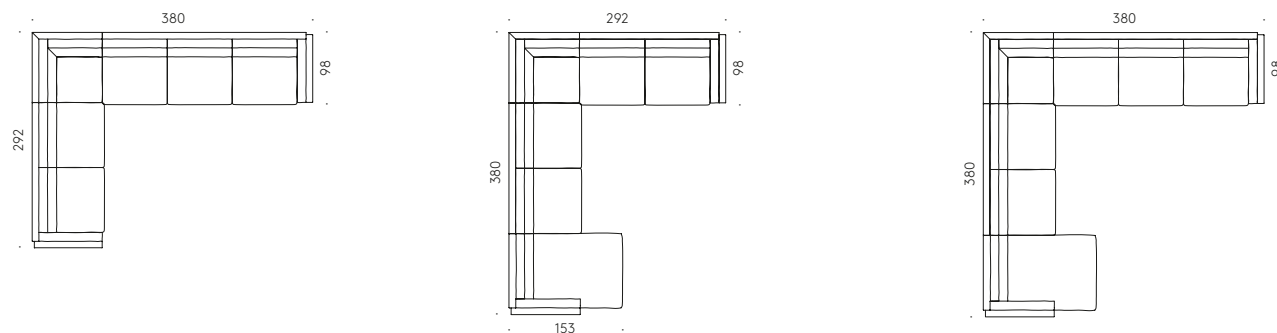

**Square Ground** — 2017

Divano a due o più posti. Struttura in legno con cinghie elastiche. Piedini regolabili in materiale termoplastico. Imbottitura in poliuretano espanso a quote differenziate e ovatta di poliestere rivestito con vellutino di poliestere. Cuscini di schienale in piuma d'oca mista a fibra di poliestere rivestita con tela di cotone. Cuscini di seduta e bracciolo in piuma d'oca con supporto in poliuretano espanso rivestito con tela di cotone. Rivestimento sfoderabile in tessuto o fisso in pelle o velluto.

Two or more-seater sofa. Frame in wood with elastic straps. Adjustable feet in thermoplastic material. Padding in variable-density polyurethane foam and polyester wadding, covered by light polyester velvet. Backrest cushions in goose down mixed with polyurethane foam particles, covered with cotton cloth. Seat and armrest cushion in goose down with support in polyurethane foam, covered with cotton cloth. Removable cover in fabric or non-removable in leather or velvet.

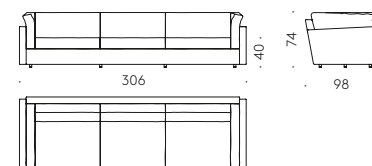
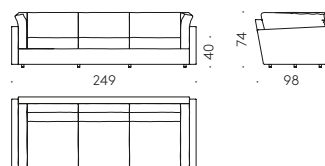
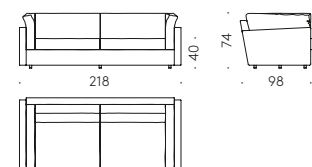
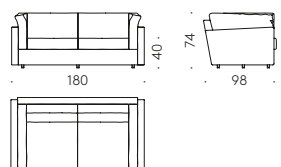

**Square Lounge** — C.R.S. De Padova, 2019

Divano a due o più posti. Struttura in legno con cinghie elastiche. Piedini in frassino tinto noce canaletto. Imbottitura in poliuretano espanso a quote differenziate e ovatta di poliestere rivestito con vellutino di poliestere. Cuscini di schienale in piuma d'oca mista a fibra di poliestere rivestita con tela di cotone. Cuscino di seduta in piuma d'oca con supporto in poliuretano espanso rivestito con tela di cotone. Rivestimento esterno sfoderabile in tessuto o fisso in pelle o velluto.

Two or more-seater sofa. Frame in wood with elastic straps. Feet in canaletto walnut stained ash. Padding in variable-density polyurethane foam and polyester wadding, covered by light polyester velvet. Backrest cushion in goose down mixed with polyurethane foam particles, covered with cotton cloth. Seat cushion in goose down with support in polyurethane foam, covered with cotton cloth. Removable cover in fabric or non-removable in leather or velvet.

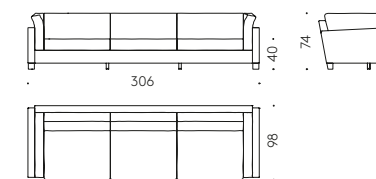
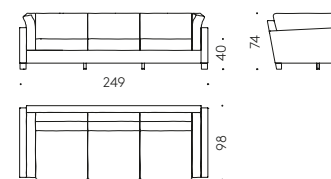
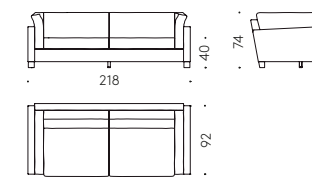
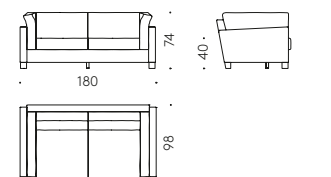

**Square Traditional** — 2017

Divano a due o più posti. Struttura in acciaio e legno con cinghie elastiche. Gambe in acciaio verniciato color canna di fucile con piedini regolabili in materiale termoplastico. Imbottitura in poliuretano espanso a quote differenziate e ovatta di poliestere rivestito con vellutino di poliestere. Cuscini di schienale in piuma d'oca mista a fibra di poliestere rivestita con tela di cotone. Cuscino di seduta in piuma d'oca con supporto in poliuretano espanso rivestito con tela di cotone. Rivestimento sfoderabile in tessuto o fisso in velluto o pelle.

Two or more-seater sofa. Frame in steel and wood with elastic straps. Legs in steel, gun-barrel grey coloured, with adjustable thermoplastic feet. Padding in variable-density polyurethane foam and polyester wadding, covered by light polyester velvet. Backrest cushion in goose down mixed with polyurethane foam particles, covered with cotton cloth. Seat cushion in goose down with support in polyurethane foam, covered with cotton cloth. Removable cover in fabric or non-removable in leather or velvet.

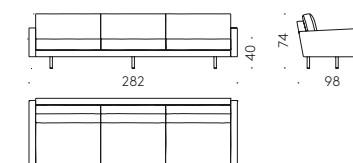
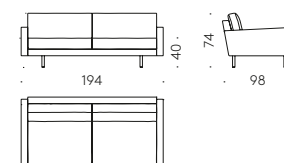

**Poltrone e Divani**  
— **Armchairs and Sofas**

**Susanna** — Vico Magistretti, 1990

Poltrona. Struttura in acciaio con cinghie elastiche. Piedini in massello di faggio tinto color noce. Imbottitura in poliuretano espanso e ovatta di poliestere rivestito con vellutino di poliestere. Cuscino di seduta in piuma d'oca con supporto in poliuretano espanso rivestito con tela di cotone. Rivestimento sfoderabile in tessuto o fisso in velluto.

Armchair. Frame in steel with elastic straps. Feet in solid beech wood, walnut coloured. Padding in polyurethane foam and polyester wadding, covered by light polyester velvet. Seat cushion in goose down with support in polyurethane foam covered with cotton cloth. Removable cover in fabric or non-removable in velvet.

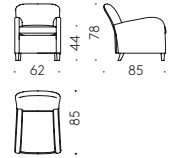

**T54** — Fratelli Monti/Archivio Storico Bonacina 1889, 1954 — *Edizioni De Padova*

Poltrona. Struttura in acciaio verniciato color nero opaco. Piedini in termoplastica. Scocca con tessitura in midollino naturale, qualità extra superiore. Optional: cuscino di seduta in poliuretano espanso e ovatta di poliestere, rivestito con vellutino di poliestere, con inferiormente superficie antiscivolo. Rivestimento sfoderabile in tessuto o in pelle.

Armchair. Frame in steel, matt black coated. Thermoplastic feet. Body with weaving in natural rattan-core, extra-high quality. Optional: seat cushion in polyurethane foam and polyester wadding, covered by light polyester velvet. Anti-slip lower surface. Cover removable in fabric or leather.

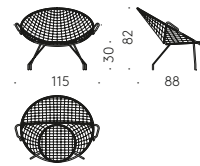

cuscini/cushions



**Tattomi** — Ingo Maurer con Jan Armgardt, 1985

Poltrona trasformabile in chaise longue e letto. Struttura in acciaio con cinghie elastiche. Slitte in MDF color nero opaco. Imbottitura in poliuretano espanso a quote differenziate e ovatta di poliestere rivestito con vellutino di poliestere. Cuscinetto poggiatesta in ovatta di poliestere rivestita con tela di cotone. Rivestimento sfoderabile in tessuto.

Armchair, that can be chaise longue and bed. Frame in steel with elastic straps. Base runner in MDF, matt black. Padding in variable-density polyurethane foam and polyester wadding, covered by light polyester velvet. Lumbar support cushion in Polyester wadding covered with cotton cloth. Removable cover in fabric.

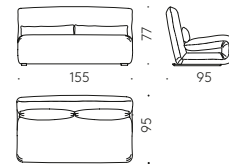
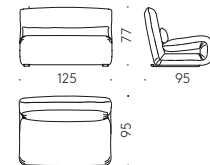
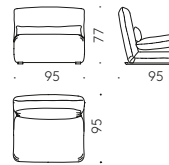

configurazioni/configurations

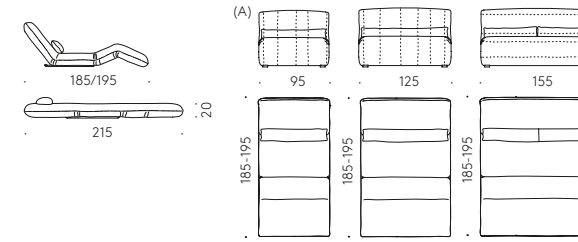

**Tondo 05** — Vico Magistretti con Birgit Lohmann, 2002

Bergère. Struttura in acciaio con cinghie elastiche. Piedini in acciaio verniciato color canna di fucile con ruote anteriori piroettanti o in legno massello di rovere naturale o tinto color wengé. Imbottitura in poliuretano espanso a quote differenziate e ovatta di poliestere rivestito con vellutino di poliestere. Cuscino poggiatesta in piuma d'oca rivestita con tela di cotone. Rivestimento sfoderabile in tessuto o fisso in velluto o pelle.

Bergère. Frame in steel with elastic straps. Coated steel in colour gun barrel feet with front swivel castors or solid wood in natural oak or wengé coated. Padding in variable-density polyurethane foam and polyester wadding, covered by light polyester velvet. Headrest cushion in goose down covered with cotton cloth. Removable cover in fabric or non-removable in leather.

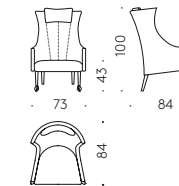
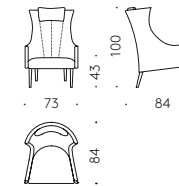

**Wingback** — Paul McCobb, 1956 — *Edizioni De Padova*

Poltrona. Struttura in legno con cinghie elastiche. Gambe in massello di frassino tinto nero. Imbottitura in poliuretano espanso a quote differenziate e ovatta di poliestere. Rivestimento fisso in tessuto o pelle.

Armchair. Frame in black-stained ash with elastic straps. Padding in variable-density polyurethane foam and polyester wadding. Non-removable cover in fabric or leather.

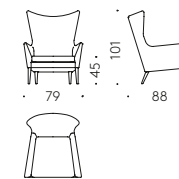

**Ottoman for Wingback** — 1956 — *Edizioni De Padova*

Pouf. Struttura in legno. Gambe in massello di frassino tinto nero. Imbottitura in poliuretano espanso a quote differenziate e ovatta di poliestere. Rivestimento fisso in tessuto o pelle.

Pouf. Frame in wood. Legs in solid black-stained ash. Padding in variable-density polyurethane foam and polyester wadding. Non-removable cover in fabric or leather.

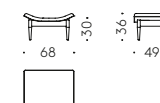

**Poltrone e Divani**  
— Armchairs and Sofas

**Yak** — LucidiPevere, 2015

Poltrona e divano a due o più posti. Struttura con telaio in acciaio verniciato con cinghie elastiche. Gambe e fasce in frassino naturale, tinto color noce canaletto o nero. Piedini regolabili in materiale termoplastico. Scocca esterna in cuoio naturale pieno fiore o cuoio pigmentato naturale o nero. Imbottitura di cuscini di seduta, schienale e bracciolo in piuma d'oca con supporto in poliuretano espanso rivestito con tela di cotone. Cuscini di seduta doubleface con lato morbido o più sostenuto. Materassino di supporto seduta in poliuretano espanso rivestito con vellutino di poliestere. Rivestimento sfoderabile in tessuto.

Armchair and two or more-seater sofa. Frame in coated steel with elastic straps. Legs and bands in natural ash, Canaletto walnut or black coloured. Adjustable thermoplastic feet. Body in natural full-grain or pigmented cowhide, natural or black. Padding: seat cushions, backrest and armrest in goose down with support in polyurethane foam covered with cotton cloth. Double-sided seat cushions: on side is soft, the other firmer. Seat support pads in polyurethane foam covered with light polyester velvet. Removable cover in fabric.

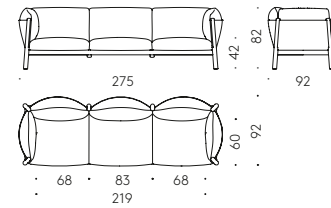
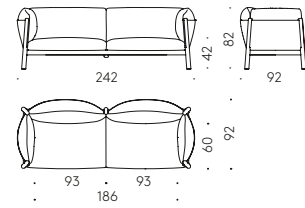
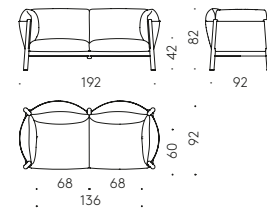
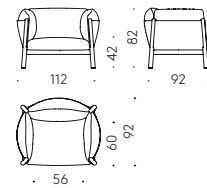

cuscini/cushions



**Yak Indoor/Outdoor** — LucidiPevere, 2019

Poltrona e divano a due o più posti. Struttura in acciaio inox verniciato colore nero con cinghie elastiche indoor/outdoor. Gambe e fasce in teak naturale. Scocca esterna in filato di polipropilene intrecciato. Cuscini di seduta doubleface (un lato è morbido, l'altro più sostenuto), cuscini di schienale e bracciolo in fibra di poliestere con supporto in poliuretano espanso rivestito con tela di poliestere idrorepellente. Rivestimento sfoderabile in tessuto indoor/outdoor.

Armchair and sofa with two or more seats. Frame in black powder coated stainless steel with elastic straps for indoor/outdoor use. Legs and bands in natural teak. External body in woven polyethylene yarn. Double-sided seat cushions (on side is soft, the other firmer), backrest and armrest in polyester fiber with support in foamed polyurethane covered with waterproof polyester cloth. Removable cover in indoor/outdoor fabric.

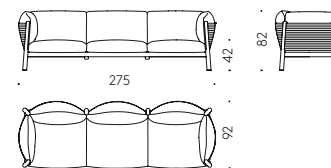
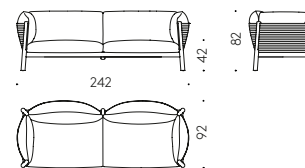
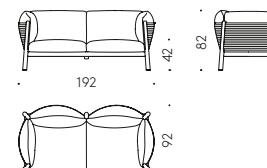
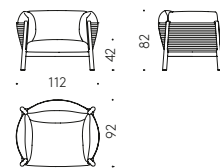

**Tavoli**  
— Tables

**3Millimetri - 3Millimetri Indoor/Outdoor** — Studiocharlie, 2017/2019

Tavolo quadrato e rettangolare con moduli aggiuntivi. Struttura e piano in lamiera di acciaio verniciata color bianco o nero o in lamiera De Castelli délabré. Nella versione Indoor/Outdoor struttura in acciaio inox verniciata color bianco o nero o in lamiera De Castelli délabré.

Square and rectangular table with additional modules. Frame and top in white or black coated steel sheet or De Castelli délabré. Indoor/Outdoor frame in stainless steel. white or black painted, or De Castelli délabré coated.

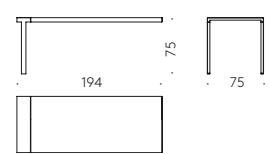
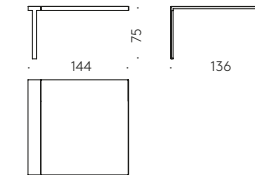
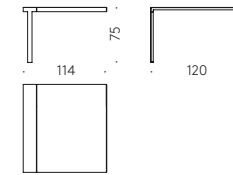
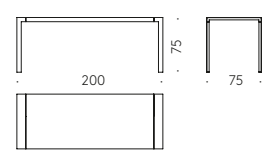
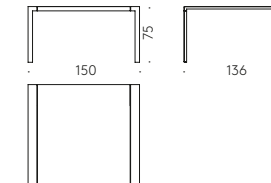
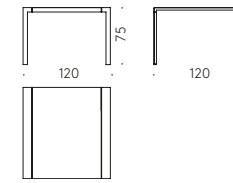

**Campo d'oro** — Paolo Pallucco e Mireille Rivier, 2005

Tavolo a geometria variabile. Base in acciaio verniciato color bianco con cerniere in acciaio inox. Piedini regolabili in acciaio inox. Top in pannelli di multistrato di betulla rivestiti in laminato HPL bianco.

Table with variable geometry. Base in white coated steel with stainless steel hinges. Stainless steel adjustable feet. Top in birch plywood panels covered in white HPL laminate.

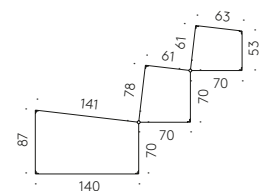
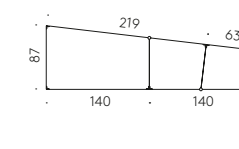
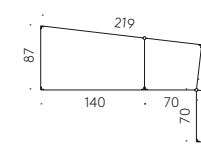
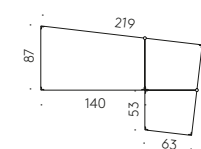
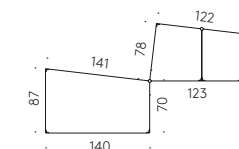
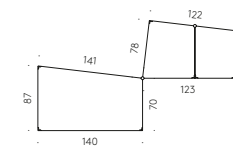
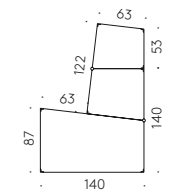
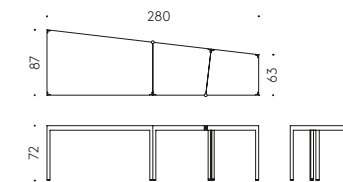
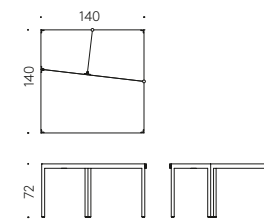

**Tavoli**  
— Tables

**Carlo** — Tono Morganti & Renato Jaime Morganti, 2019 — *Edizioni De Padova*

Tavolo rotondo. Base in multistrato impiallacciato in frassino tinto carbone. Piedini regolabili in materiale termoplastico. Piano in multistrato e impiallacciato in frassino tinto carbone, con bordo in massello di frassino tinto carbone.

Round table. Base in plywood and veneered in charcoal-stained ash. Adjustable feet in thermoplastic material. Top in multilayer and veneered in charcoal-stained ash, with edge in solid charcoal-stained ash.

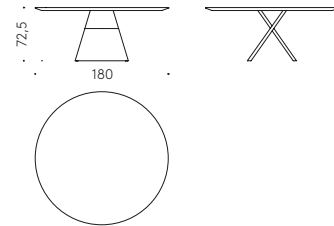
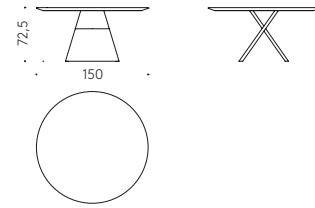

**French Concession** — Piero Lissoni, 2019

Tavolo rotondo. Struttura portante (non a vista) in acciaio verniciato a polvere. Base e piano in Corian bianco. Struttura interna di supporto in acciaio.

Round table. Bearing structure (not visible) in powder-coated steel. Base and top in white Corian. Supporting internal structure in steel.

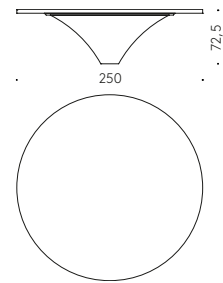

**Mawari** — Gunther Pelgrims, 2019

Tavolo rotondo. Base in massello di rovere naturale. Rinforzi interni in acciaio. Inserti in massello wengè. Piano stratificato in massello di rovere naturale con inserti in wengè. Optional: vassoio in massello di rovere naturale con inserti in wengè.

Round table. Base in solid natural oak with internal steel reinforcements. Decorating inserts in solid wenge wood. Top in solid wood layers in natural oak with decorating inserts in wenge. Optional: tray in solid natural oak with decorating inserts in wenge.

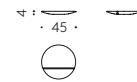
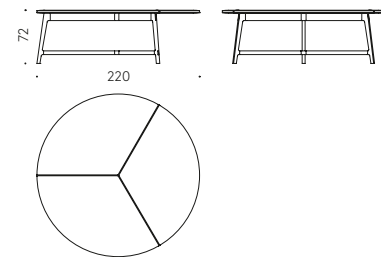

**Otis** — Lorenz\*Kaz, 2007/2008

Tavolo rotondo. Base in lamiera di acciaio verniciato color bianco o nero. Piedini regolabili. Top in multistrato di betulla rivestito con laminato HPL color bianco opaco oppure rivestito con superficie nanotecnologica Fenix NTM® nero opaco "soft touch".

Round table. Base in steel sheet, white or black coated. Adjustable feet. Top in birch plywood covered in HPL laminate matt white coloured or covered with Fenix NTM® nanotechnology surface, matt black "soft touch".

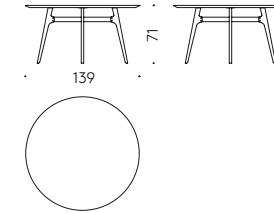
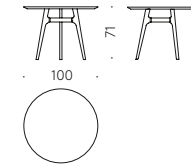

**Quadrato** — 1986

Tavolo quadrato e rettangolare. Base in acciaio verniciato color bianco, piedini in materiale termoplastico. Top in pannello di particelle di legno con bordo in multistrato di compensato marino rivestito con laminato HPL di colore bianco.

Square or rectangular table. Base in steel white coated. Thermo-plastic feet. Top in wood particle board panel with edging in marine plywood, covered in white HPL laminate.

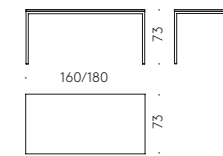
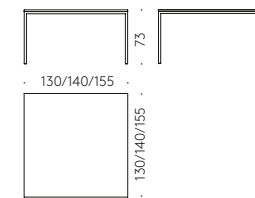

**Shadow** — Vincent Van Duysen, 2011

Tavolo quadrato o rettangolare. Struttura interna in acciaio. Base e piano con finitura bicolore in laminato HPL stratificato impiallacciato.

Square and rectangular table. Internal frame in steel. Base and top with bicolour finish in laminate HPL veneered.

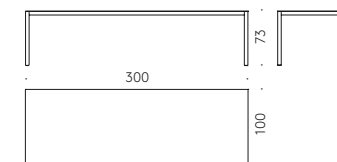
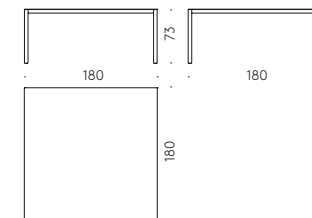

**Tavoli**  
— Tables

**Shine** — Vico Magistretti, 1991

Serie di tavoli. Base con gambe in alluminio con rinforzi interni in acciaio, lucidate a specchio o verniciate nei colori bianco opaco o nero opaco. Traverse e supporti del piano in acciaio verniciato color alluminio, bianco opaco o nero opaco. Piedini regolabili in materiale termoplastico. Top: in legno con pannello impiallacciato in rovere naturale o noce canaletto con bordo sagomato in massello. O in MDF rivestito con laminato bianco con bordo sagomato. Oppure in MDF con superficie nanotecnologica Fenix NTM® colore nero opaco "soft touch" con bordo sagomato.

Series of tables. Base with Legs in aluminium with internal steel reinforcements, polished or coated, matt white or matt black. Cross-bars and top supports in coated steel, in aluminium, matt white or matt black coloured. Adjustable thermoplastic feet. Top: in wood particle board panel, veneered in natural oak or Canaletto walnut with solid wood shaped edge. Or laminate top in MDF covered in white HPL laminate with shaped edge. Or in MDF with Fenix NTM® nanotechnology surface, in matt black "soft touch", with shaped edge.

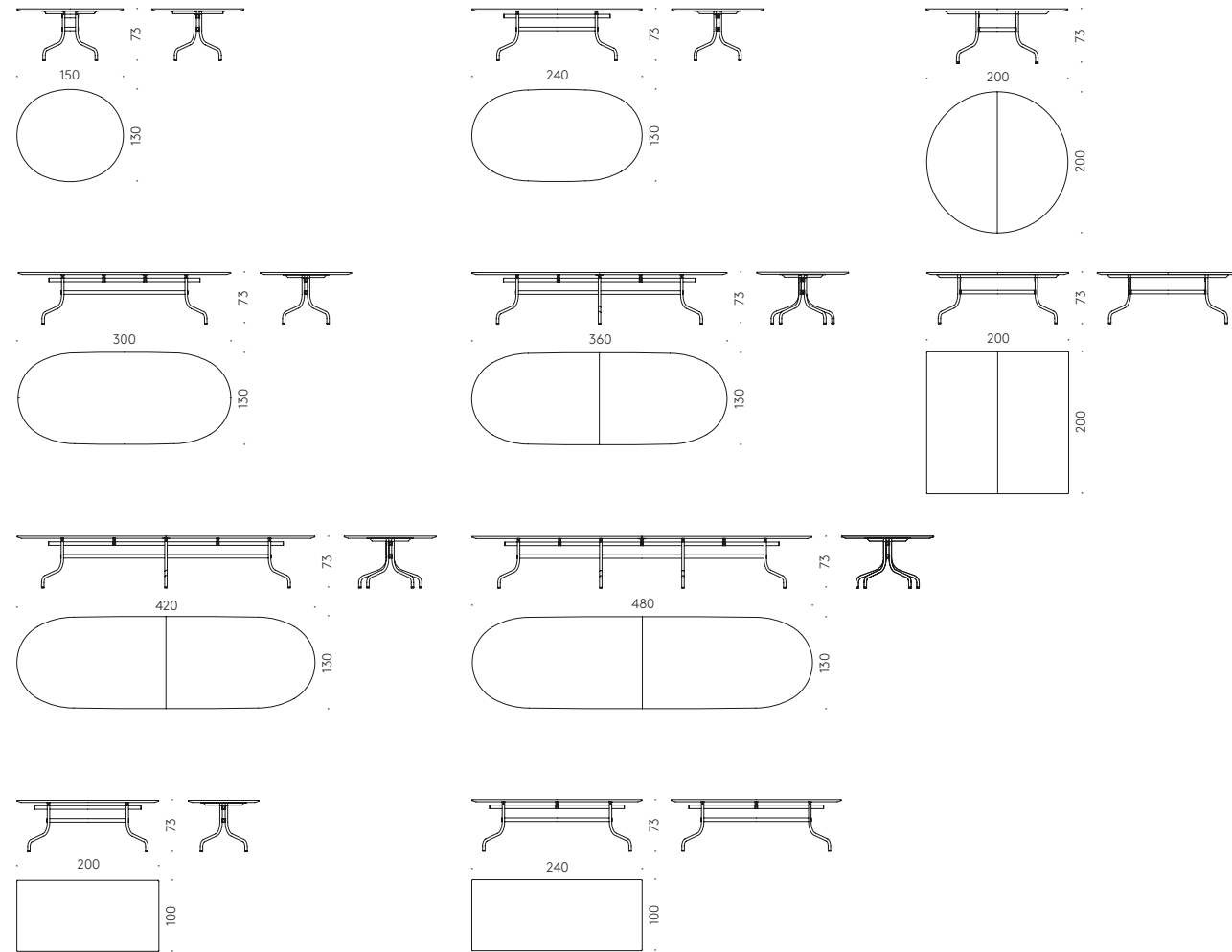

**Tavolo '95** — Achille Castiglioni, 1995

Serie di tavoli. Versione rotonda anche con vassoio girevole. Base con gambe in massello di frassino tinto color carbone. Telaio in acciaio e staffe in alluminio, verniciati color nero opaco. Top: piano in pannello di particelle di legno impiallacciato in rovere affumicato, bordo in massello di rovere affumicato. Oppure con piano in marmo Calacatta Oro o Valentine Grey o Grey Stone o Gris du Marais | Lithoverde® o Pietra d'Avola | Lithoverde®.

Series of tables. Round version also with Lazy Susan rotating tray. Base with legs in solid ash wood, charcoal coloured. Steel frame and brackets made of aluminium, matt black coated. Top: in wood particle board panel, veneered in smoked oak with solid smoked oak edge. Or top in Calacatta Oro marble or Valentine Grey or Grey Stone or Gris du Marais | Lithoverde® or Pietra d'Avola | Lithoverde®.

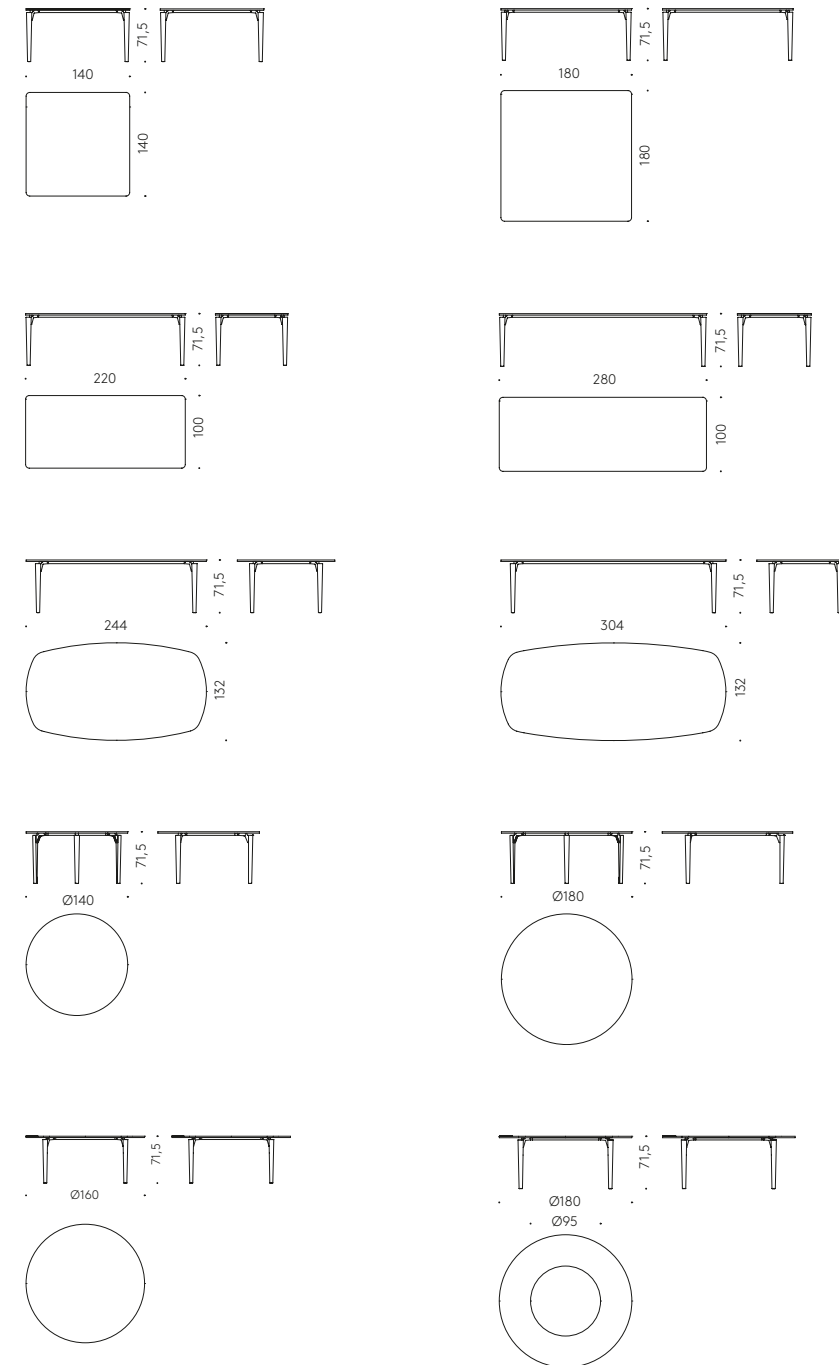



## Tavoli — Tables

### Tools 16 — Studio Cerri & Associati, 2002

Tavolo rettangolare. Base in alluminio, verniciata color bianco opaco. Piedini regolabili in alluminio. Top: piano in multistrato di betulla rivestito con laminato HPL color bianco, bordo in PVC bianco semitrasparente.

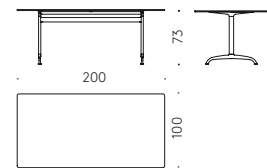
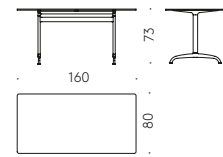

Rectangular table. Base in aluminium, matt white coated. Aluminium adjustable feet. Top: birch plywood covered in white HPL laminate. Edge in PVC, semitransparent white.

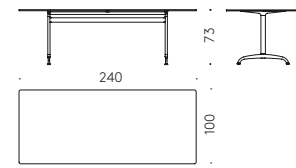
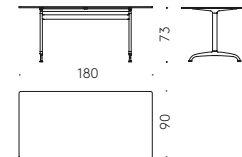

### Vidun — Vico Magistretti, 1987

Tavolo rettangolare o rotondo. Base in massello di noce canaletto, oppure in massello di faggio naturale o laccato color bianco o nero, o tinto color viola-turchese-verde o rosso-giallo-giallo becco d'oca. Piano in vetro extrachiaro, spessore 12 mm, temperato, bordo a filo lucido.

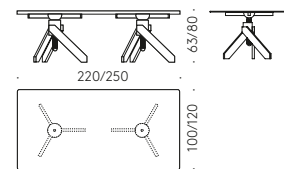

Rectangular or round table. Base in solid Canaletto walnut, or in solid natural beech or with acrylic paint (white or black) or aniline-dyed (violet-turquoise-green or red-yellow-goose beak yellow). Top in extra-clear tempered glass, 12 mm. thick. Polished edge.

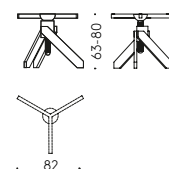
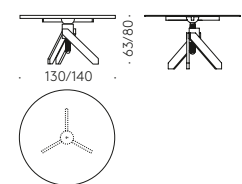

### Lazy Susan — C.R.S. De Padova, 2019

Serie di vassoi girevoli da appoggio. Meccanismo rotante in alluminio. Piano e vassoio girevole in Marmo Bianco Carrara, Calacatta Oro, Valentine Grey o Grey Stone trattato con prodotti idrorepellenti.

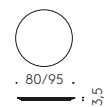

Series of lazy Susan rotating trays. Rotating mechanism in aluminium. Top and rotating tray in white Carrara marble, Calacatta Oro, Grey Stone or Valentine Grey, treated with water repellent products.

## Sedie e Sgabelli — Chairs and Stools

### Chesto — Patrick Nourget, 2014

Sedia. Struttura in acciaio con cinghie elastiche. Gambe in massello di frassino sbiancato, o color noce canaletto o nero. Imbottitura in poliuretano espanso e ovatta di poliestere rivestito con vellutino di poliestere. Rivestimento sfoderabile in tessuto o fisso in velluto o pelle.

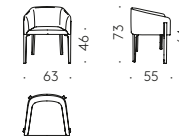

Chair. Frame in steel with elastic straps. Feet in solid bleached ash wood or Canaletto walnut or black coloured. Padding in polyurethane foam and polyester wadding, covered by light polyester velvet. Removable cover in fabric or non-removable in velvet or leather.

### Chesto Lounge — Patrick Nourget, 2018

Sedia. Struttura in acciaio con cinghie elastiche. Gambe in massello di frassino sbiancato, o color noce canaletto o nero. Imbottitura in poliuretano espanso e ovatta di poliestere rivestito con vellutino di poliestere. Rivestimento sfoderabile in tessuto o fisso in velluto o pelle.

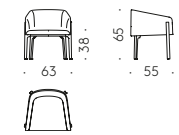

Chair. Frame in steel with elastic straps. Feet in solid bleached ash wood or Canaletto walnut or black coloured. Padding in polyurethane foam and polyester wadding, covered by light polyester velvet. Removable cover in fabric or non-removable in velvet or leather.

### Cirene — Vico Magistretti, 1999

Sedia fissa con e senza braccioli. Versione impilabile (fino a 10 sedie) e versione imbottita non impilabile. Struttura in acciaio cromato lucido o verniciato nero opaco. Piedini in materiale termoplastico. Seduta rigida in multistrato di faggio laccato color grigio antracite, o rivestito in laminato bianco con bordo a vista in multistrato di faggio, o impiallacciato in acero naturale, o in faggio tinto color rosso. Seduta imbottita in poliuretano espanso con vellutino di poliestere. Rivestimento fisso in tessuto o in pelle.

Standing chair with or without armrests. Stackable version (up to 10 chairs) and padded not stackable version. Feet in thermoplastic material. Frame in chrome-plated polished or matt black painted steel. Firm seat in beech plywood, covered with anthracite grey polyurethane paint or with white laminate, with visible edge in beech plywood or veneered in natural maple, or in red aniline-dyed beech. Frame in beech plywood. Upholstered seat with polyurethane foam, covered by light polyester velvet. Non-removable cover in fabric or leather.

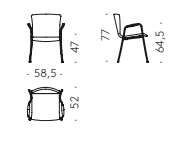
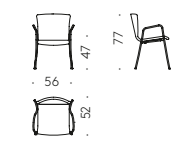
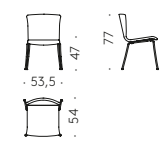
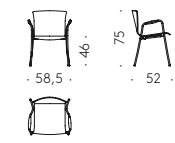
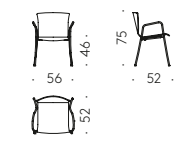
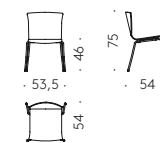

## Sedie e Sgabelli — Chairs and Stools

### Donzella — Michele De Lucchi, 2013

Sedia. Struttura in massello di frassino naturale o laccato nero. Sedile con telaio in multistrato intrecciato a mano con corda di carta naturale o imbottito in poliuretano espanso e rivestito in pelle o tessuto. Rivestimento fisso in tessuto o in pelle.

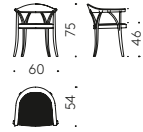

Chair. Frame in solid ash wood or black lacquered. Seat with frame in plywood, hand-woven with natural paper cord or padded in polyurethane foam and covered in leather or fabric. Non-removable cover in fabric or leather.

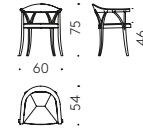

### Donzelletta — Michele De Lucchi, 2017

Sedia. Struttura in massello di frassino sbiancato o tinto color nero. Sedile in multistrato di betulla, imbottito in poliuretano espanso, oppure rivestito con corda in carta naturale intrecciata a mano. Rivestimento fisso in tessuto o in pelle.

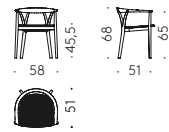

Chair. Frame in solid ash wood, bleached or black coloured. Seat in birch plywood, covered with hand-woven natural paper cord or padded in polyurethane foam. Non-removable cover in fabric or leather.

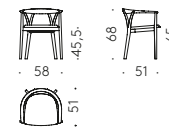

### Florinda — Monica Förster, 2011

Sedia. Impilabile fino a 5 sedie. Struttura in massello di faggio naturale o tinto color moka. Piedini in materiale termoplastico. Seduta e schienale in ABS con fibra di vetro finiti con vernice goffrata color bianco o nero.

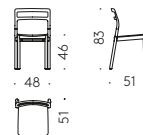

Chair. Stackable up to 5 chairs. Frame in solid natural or mocha-stained solid beech wood. Feet in thermoplastic material. Backrest and seat in ABS with fibreglass, finished with embossed paint, white or black.

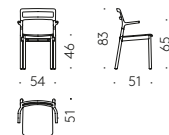

### Incisa — Vico Magistretti con Centro Design Binfaré, 1992

Sedia girevole. Base girevole a quattro razze: acciaio cromato lucido con piedini in termoplastica. Base girevole a cinque razze: acciaio cromato lucido con ruote piroettanti in materiale termoplastico con freno di sicurezza. Struttura in poliuretano rigido. Scocca esterna in cuoio pieno fiore. Imbottitura in poliuretano espanso a quote differenziate e ovatta di poliestere rivestito con vellutino di poliestere. Rivestimento interno in pelle o in tessuto e sfoderabile tramite cerniera zip.

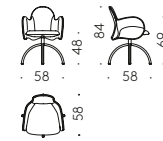

Swivel chair. Swivel four-spoke base: chromium-plated polished steel with thermoplastic feet. Swivel five-spoke base: chromium-plated polished steel with thermoplastic swivel castors with safety brake. Frame in rigid polyurethane. Body in full-grain cowhide. Padding in variable-density polyurethane foam, covered by light polyester velvet. Cover in leather or fabric, removable with zipper.

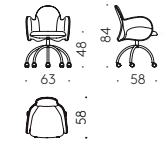

### Lady Pollack — Vico Magistretti, 1998-2016

Sedia. Struttura in acciaio con cinghie elastiche. Gambe in massello di frassino color carbone. Imbottitura in poliuretano espanso e ovatta di poliestere, rivestito con vellutino di poliestere. Rivestimento sfoderabile in tessuto.

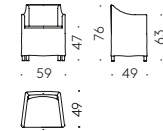

Chair. Frame in steel with elastic straps. Legs in solid ash, charcoal coloured. polyurethane foam and polystere wadding, covered by light polyester velvet. Removable cover in fabric.

### Lavenham Executive — Patricia Urquiola, 2010

Sedia. Base fissa: supporti in acciaio verniciato bianco o nero e gambe in noce canaletto o frassino tinto rovere. Piedini in termoplastica. Base girevole a quattro razze: alluminio lucido o verniciato bianco o nero. Piedini in termoplastica. Base girevole a cinque razze regolabile in altezza: alluminio lucido o verniciato bianco o nero, ruote piroettanti in termoplastica. Scocca in poliuretano strutturale ad alta densità TECH® bianco o nero. Superficie opaca con motivo trapuntato stampato sulla superficie esterna. Optional: cuscino di seduta con imbottitura in poliuretano espanso e ovatta di poliestere rivestito in vellutino di poliestere, con superficie antiscivolo nella parte inferiore. Rivestimento sfoderabile in tessuto.

Chair. Fixed base: supports in coated steel, white or black, and legs in Canaletto walnut or ash oak-stained. Feet in thermoplastic. Swivel four-spoke base: aluminium polished casting or coated, white or black, with thermoplastic feet. Swivel five-spoke base height-adjustable: aluminium polished or coated, white or black, swivel thermoplastic castors. Body in TECH® high-density structural polyurethane, white or black. Matt surface and quilted pattern on the external surface. Optional: seat cushion with polyurethane foam and polystere wadding, covered by light polyester velvet. Anti-slip lower surface. Removable cover in fabric.

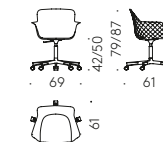
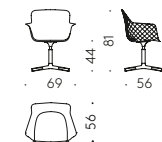
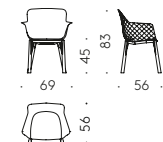

cuscini/cushions



## Sedie e Sgabelli — Chairs and Stools

### M16—2016

Sedia con braccioli. Struttura in massello di frassino sbiancato o color nero. Sedile in multistrato di betulla, impiallacciato in frassino sbiancato o color nero, oppure seduta impagliata con corteccia di giunco naturale, oppure in multistrato di betulla, imbottito in poliuretano espanso con rivestimento fisso in tessuto o in pelle.

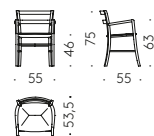

Chair with armrests. Frame in solid ash, bleached or black. Seat in shaped birch plywood, veneered in ash wood and aniline-dyed, bleached or black, finished with transparent water-based or rush seat with natural cane bark, or in birch plywood, upholstered with polyurethane foam. Non removable cover in fabric or leather.

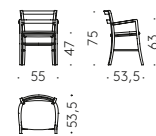
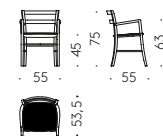

### Marocca—Vico Magistretti, 1987

Sedia con braccioli. Struttura in massello di faggio laccato color nero semilucido. Sedile in multistrato di faggio stampato e laccato color nero semilucido.

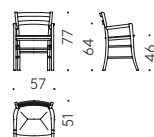

Chair with armrests. Frame in solid beech wood, painted semi-glossy black. Seat in shaped birch plywood, painted semi-glossy black.

### Olimpia—Vico Magistretti, 2008/2019

Sgabello. Versione impilabile (fino a 6 sgabelli) e versione imbottita non impilabile. Struttura in acciaio verniciato color nero. Piedini in materiale termoplastico. Scocca in multistrato rivestito in laminato bianco con bordo a vista in multistrato di faggio, o impiallacciato in acero naturale, in rovere tinto wengè. Seduta imbottita in multistrato e poliuretano espanso con vellutino di poliestere. Rivestimento fisso in tessuto o pelle.

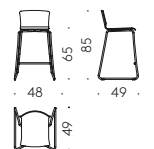

Stool. Stackable version (up to 6 stools) and non-stackable upholstered version. Frame in black painted steel with footrest in black painted steel. Feet in thermoplastic material. Multi-layered body covered in white laminate with visible edge in beech plywood, veneered in natural maple, wenge-stained oak. Seat upholstered in plywood and polyurethane foam with polyester velvet. Non-removable cover in fabric or leather.

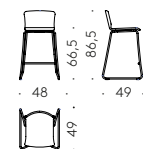

### Pollack—Vico Magistretti, 1998

Sedia. Struttura in acciaio con cinghie elastiche. Gambe in rovere naturale o in frassino tinto color carbone. Imbottitura in poliuretano espanso e ovatta di poliestere rivestito con vellutino di poliestere. Rivestimento sfoderabile in tessuto o fisso in velluto.

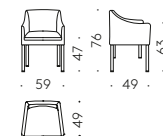

Chair. Frame in steel with elastic straps. Legs in natural oak or ash wood, charcoal coloured. polyurethane foam and polystere wadding, covered by light polyester velvet. Removable cover in fabric or non-removable in velvet.

### Rea—Paolo Tilche, 1956 — Edizioni De Padova

Sedia. Struttura in acciaio verniciato color nero opaco. Seduta e schienale in cuoio pieno fiore e tinto all'anilina color naturale.

Chair. Frame in coated steel, matt black-coloured. Seat and backrest in full-grain cowhide and aniline dyed.

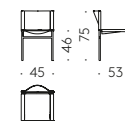

### Serbelloni—Vico Magistretti con Centro Design Binfarè, 1994

Sedia direzionale girevole, con ruote, inclinabile e regolabile in altezza. Struttura in acciaio con cinghie elastiche. Ruote piroettanti in materiale termoplastico con freno di sicurezza. Scocca posteriore in cuoio pieno fiore. Base in acciaio cromato lucido con regolazione in altezza e meccanismo basculante. Imbottitura in poliuretano espanso a quote differenziate e ovatta di poliestere rivestito con vellutino di poliestere. Rivestimento in pelle o in tessuto sfoderabile tramite cerniera zip.

Small reclining and height-adjustable executive swivel armchair with castors. Frame in steel with elastic straps. Swivel thermoplastic castors with safety brake. Base in polished chromium-plated steel with height-adjustment and self-stabilizing mechanism. External cover in full-grain cowhide. Padding in variable-density polyurethane foam and polystere wadding, covered by light polyester velvet. Internal cover in leather or fabric removable with zipper.

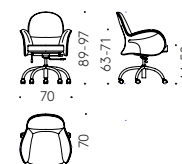

**Sedie e Sgabelli**  
— Chairs and Stools

**Silver** — Vico Magistretti, 1989

Sistema di sedute. Sedia con o senza braccioli; sedia impilabile (fino a sei sedie); sedia girevole su ruote; sgabello; sedie multiple su barra e accessori. Struttura gambe/schienale/braccioli in alluminio anodizzato satinato, anodizzato lucido o verniciato color bianco opaco o nero opaco. Piedini in materiale termoplastico. Base girevole a 5 razze in acciaio verniciato color alluminio, bianco opaco o nero opaco. Ruote piroettanti in materiale termoplastico con freno di sicurezza. Altezza della seduta regolabile. Seduta e schienale in polipropilene o in alluminio anodizzato lucido. Optional: cuscino di seduta, tavoletta di scrittura, carrello per trasporto, tavolino su barra.

Seating system. Chairs, with or without armrests; stackable chairs (up to six chairs); swivel chairs on castors; stools; multiple beam-mounted chairs and accessories. Frame of legs/backrest/armrests in satin-finished anodized aluminum, polished or coated, matt white or black. Feet in thermoplastic material. Swivel five-spoke base coated steel, aluminium finish, matt white or black. Swivel castors in thermoplastic material, with safety brake. Height-adjustable seat. Seat and backrest in polypropylene or in polished anodized aluminum. Optional: seat cushion, writing table, small table on beam, cart for transport.

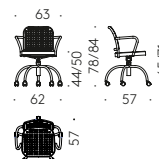
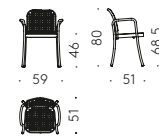
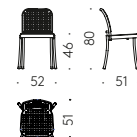
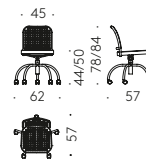
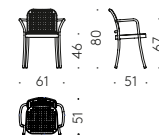
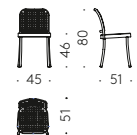

sgabello/stool

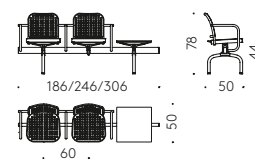
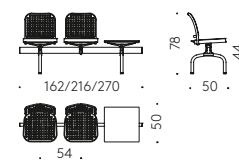
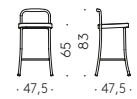

tavoletta di scrittura/writing surface

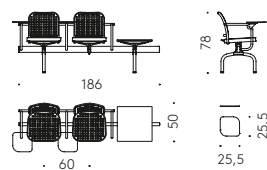
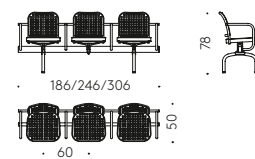
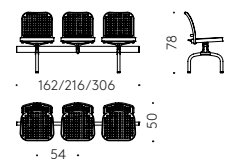
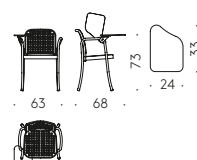

barra di congiunzione/joint bar



ganci/hooks

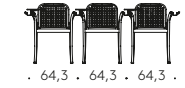
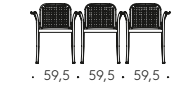

carrello/dolly cart

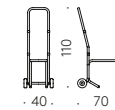

cuscini/cushions



seduta e schienale/seat and back



**Silver Outdoor** — Vico Magistretti, 1989

Sistema di sedute. Sedia con o senza braccioli; sedia impilabile (fino a sei sedie). Struttura in tubolare di alluminio anodizzato satinato o anodizzato lucido o verniciato nei colori bianco opaco e nero opaco (solo per la versione fissa, non impilabile). Piedini in materiale termoplastico. Telaio di seduta in alluminio pressofuso con trattamento speciale di protezione per uso esterno, verniciato color alluminio oppure color bianco opaco o nero opaco (solo per la versione fissa, non impilabile). Seduta e schienale in polipropilene.

Seating system. Chair with or without armrests; stackable chair (up to six chairs). Satin-finished anodized tubular aluminum, polished or coated - matt white or black (only for the non-stackable version). Feet in thermoplastic material. Seat frame in die-cast aluminium with special treatment for external use, aluminium finish or matt white matt black (only for the non-stackable version). Seat and backrest in polypropylene.

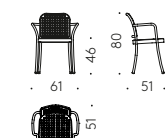
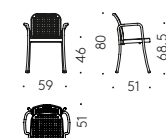
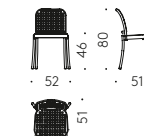
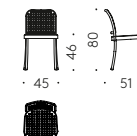

**So** — Naoto Fukasawa, 2017

Sedia. Struttura in massello di frassino tinto color grigio cenere. Schienale in multistrato di betulla stampato. Rivestimento in cuoio pigmentato nero.

Chair. Frame in Solid ash wood, ash grey coloured. Backrest in printed birch plywood. Cover in black pigmented cowhide.

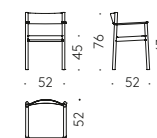

**Sedie e Sgabelli**  
— **Chairs and Stools**

**Sundance** — Paolo Golinelli, 2010

Sedia pieghevole. Struttura in massello di teak. Cerniere in acciaio inox spazzolato fine. Piedini in termoplastica. Braccioli imbottiti in poliuretano espanso. Rivestimento in tessuto 100% acrilico per outdoor.

Small folding armchair. Frame solid teak. Brushed stainless steel hinges. Thermoplastic feet. Armrests padded in polyurethane foam. Cover in 100% acrylic fabric for outdoor.

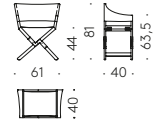

**Uragano** — Vico Magistretti, 1992

Sedia. Struttura massello di frassino sbiancato o color nero. Seduta, schienale e braccioli in midollino naturale o color nero. Optional: cuscino di seduta in poliuretano espanso e ovatta di poliestere, rivestito con vellutino di poliestere. Rivestimento sfoderabile in tessuto.

Small armchair with frame in solid ash wood, bleached or black. Seat, backrest and armrests in rattan-core natural or black aniline-dyed. Optional: seta cushion in polyurethane foam and polyester wadding, covered by light polyester velvet. Removable cover in fabric.

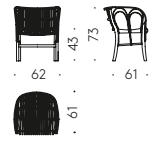

cuscini/cushions



**Librerie e contenitori**  
— **Bookcases and containers**

**606 Universal Shelving System** — 1984

Libreria. Libreria di grande flessibilità, sia a parete sia divisoria, con elementi di contenimento, realizzata in alluminio anodizzato satinato o anodizzato nero opaco o vernicato color bianco.

Shelving and storage system. Shelving system with unmatched flexibility, wall version and uprights version for partition shelving, in satin-finished anodised aluminium or matt black finish, or in coated aluminium, matt white.

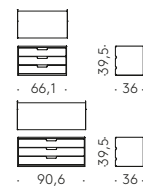
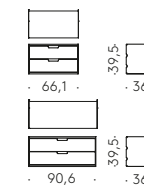
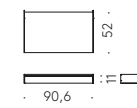
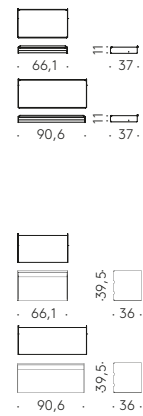
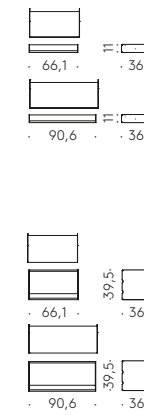
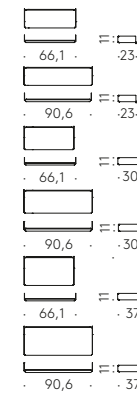
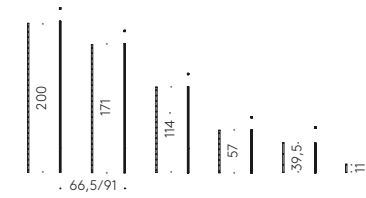
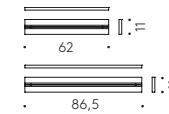
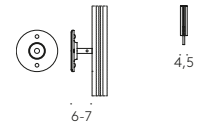
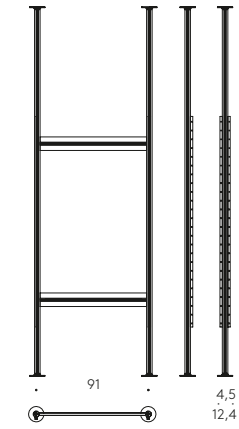
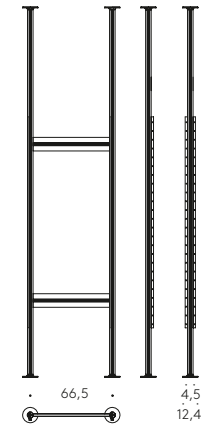



**Librerie e contenitori**  
— Bookcases and storage units

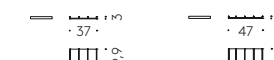
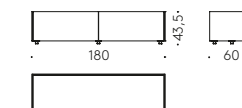
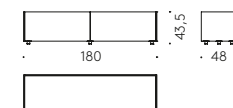
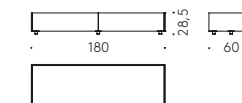
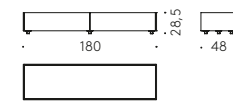
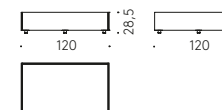
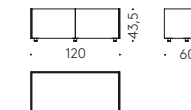
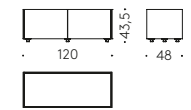
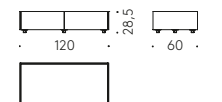
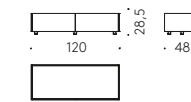
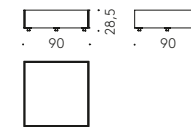
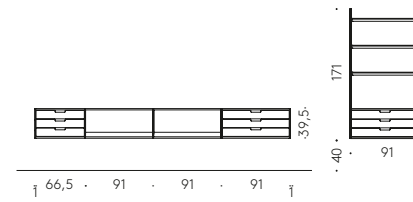
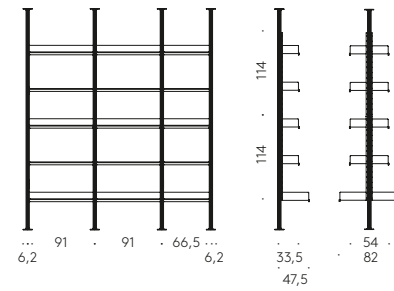
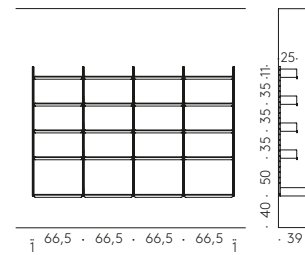

**Combi Cabinets** — Piero Lissoni, 2019

Serie di contenitori. Base in acciaio verniciato nero opaco, piedino regolabile in metallo. Contenitore in pannelli di particelle di legno in nobilitato nero Sablè. Oppure pannelli di listellare impiallacciati in rovere Dark. Cassetti in pannelli di particelle di legno in nobilitato nero Sablè. Oppure pannelli di listellare impiallacciati in rovere Dark per contenitori impiallacciati in legno. Frontali: laccati lucidi in poliestere; listellare impiallacciati rovere Dark spazzolato o rovere Dark freehand o accoppiato con lamiera De Castelli in ottone striato, acciaio délabré grigio, acciaio délabré scuro o ottone freehand; alluminio verniciato a polvere color nero DRY. Top in vetro riflettente retroverniciato caffè oppure laccato lucido in poliestere oppure in lamiera De Castelli in ottone striato, acciaio striato grigio, acciaio délabré scuro o ottone freehand.

Series of cabinets. Base in matt black painted steel, with metal adjustable feet. Carcass in melamine-coated wood particle panels black Sablè. Or blockboard veneered in Dark oak. Drawers in panels in wood particle board, in melamine-coated Sablè black for cabinets in Sablè black melamine-coated. Or blockboard veneered in Dark oak, for cabinets veneered in wood. Front panels: glossy lacquered in polyester; blockboard veneered in brushed Dark oak or Dark oak freehand or coupled with De Castelli sheet in striped brass, grey striped steel, dark délabré steel or brass freehand; black DRY powder-coated aluminium. Top in back-painted reflective glass, coffee coloured or glossy lacquered in polyester or De Castelli sheet in striped brass, grey striped steel, dark délabré steel or brass freehand.

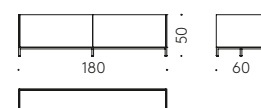
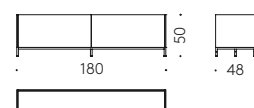
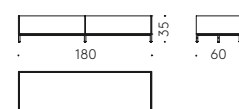
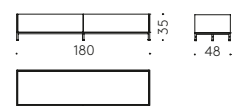
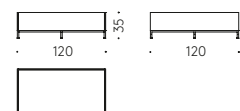
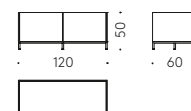
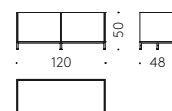
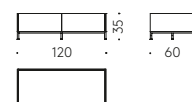
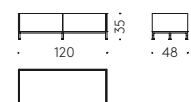
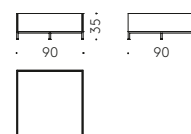

**Combi Madia** — Piero Lissoni, 2019

Madia. Base in metallo verniciato a polvere colore brunito. Contenitore in pannelli di particelle di legno nobilitato rovere grafite. Telaio interno in metallo verniciato a polvere colore brunito. Cassetti con frontali in lamiera di metallo verniciata a polvere colore brunito. Frontali in legno massello di abete "antico" grigio, frassino olivato termotrattato SW, rovere Dark oppure rovere tinto carbone spazzolato. Esclusive cerniere regolabili e chiavistello di chiusura in metallo brunito. Rivestimento interno dello schienale in vetro a specchio. Ripiani in vetro extrachiaro trasparente temperato. Illuminazione interna a LED.

Madia. Base in powder-coated metal, bronze coloured. Carcass in melamine-coated graphite oak particle panels. Internal frame in powder-coated metal, bronze coloured. Drawers with fronts in powder-coated metal sheet, bronze coloured. Front panels in solid old grey pinewood, thermo-treated olive ash SW, Dark oak or brushed charcoal-stained oak. Exclusive adjustable hinges and door lock in burnished metal. Internal covering of back panel in mirrored glass. Shelves in tempered, transparent, extra clear glass. LED internal lighting.

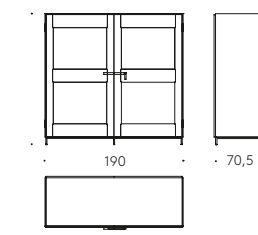
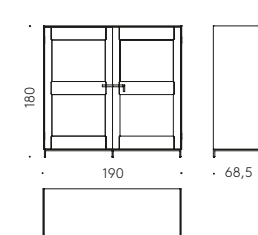

**Librerie e contenitori**  
— Bookcases and containers

**Combi Open Units - Combi Sideboard** — Piero Lissoni, 2019

Contenitore a giorno e madia. Struttura in pannelli di listellare impiallacciati in rovere naturale, rovere Dark o rovere tinto all'anilina color carbone. Montante e basi in acciaio verniciato a polvere color nero opaco, piedino regolabile in metallo stampato. Ripiani in vetro extrachiaro trasparente temperato. Schienale in vetro retinato oppure vetro riflettente temperato retroverniciato oppure caffè. Top in vetro riflettente temperato retroverniciato caffè. Illuminazione interna (opzionale): quattro faretto LED.

Open-faced unit and sideboard. Carcass in blockboard veneered in natural oak, Dark oak or aniline-dyed charcoal-coloured oak. Uprights and bases in matt black powder-coated steel, adjustable feet in metal. Shelves in tempered, transparent, extra clear glass. Back panel in wired glass or tempered back-painted reflective glass, coffee-coloured. Top in tempered back-painted reflective glass, coffee-coloured. Internal lighting (optional): four LED spotlights.

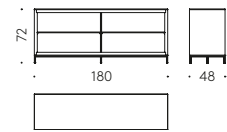
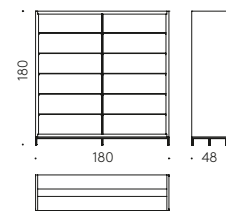

**Kant** — Formförsorge, 1993

Libreria. Libreria contenitore a colonna, realizzata in acciaio verniciato a polvere color bianco opaco.

Tall shelving unit. Tall shelving unit in coated steel, matt white coloured.

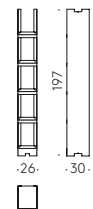

**SC16** — 2016

Sistema di contenitori. Contenitore e cassetti in pannelli impiallacciati in Abonos Oak o rovere affumicato. Frontali cassetti in impiallacciati in Abonos Oak, rovere affumicato, lamiera in ottone striato, acciaio striato grigio o acciaio delabrè scuro. Top impiallacciato in Abonos Oak o rovere affumicato. Oppure con pannello in alluminio rivestito con lamiera in ottone striato, acciaio striato grigio o acciaio delabrè scuro. Oppure top in Marmo Grey Stone o Bianco Carrara o Calacatta Oro. Base in acciaio verniciato nero opaco e piede in acciaio brunito. Piedino regolabile in termoplastica.

Cabinet system. Unit and drawers in panels veneered in Abonos Oak or smoked oak. Drawer front panels in panels veneered in Abonos Oak, smoked oak, striped brass, striped grey steel or dark delabrè steel. Top veneered in Abonos Oak, smoked oak. Or with panel in aluminum, coated with sheet in striped brass, grey striped steel or dark delabrè steel. Or in Grey Stone or White Carrara or Calacatta Gold marble. Base in matt black painted steel, and feet in burnished steel. Adjustable thermoplastic foot.

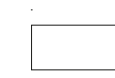
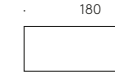
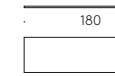
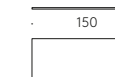
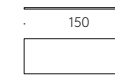
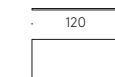
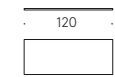
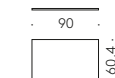
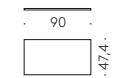
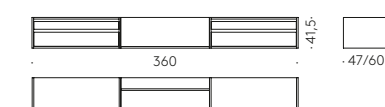
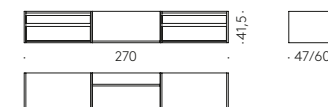
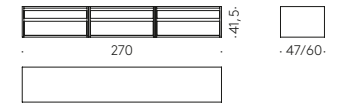
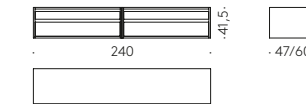
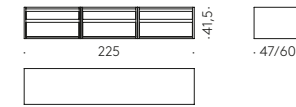
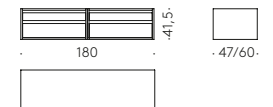
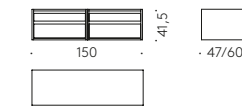
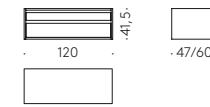
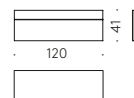
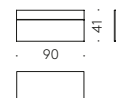
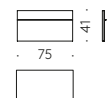

4

**Librerie e contenitori**  
— **Bookcases and containers**

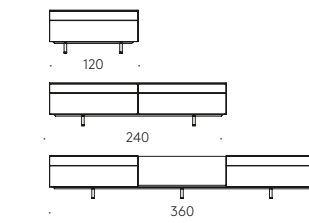
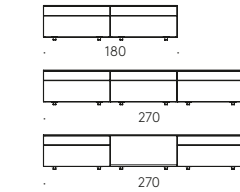
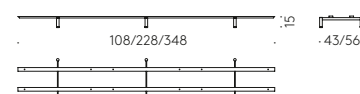
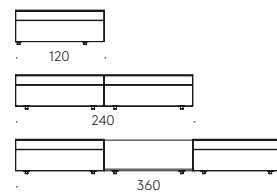
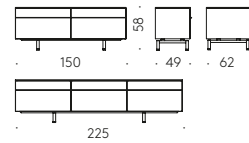
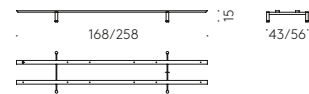
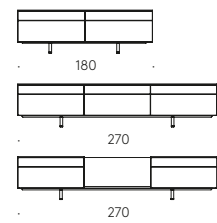
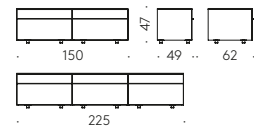
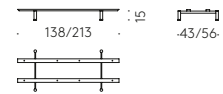

**Shigeto**—Vico Magistretti, 1989

Madia a due ante su ruote. Struttura e ripiani con parti in massello di rovere naturale e parti in pannelli di particelle di legno impiallacciate in rovere naturale. Ruote piroettanti. Le ruote anteriori sono dotate di un sistema di bloccaggio.

Two-door cupboard with castors. Frame and shelves in solid natural oak and panels in veneered in natural oak. Swivel castors. The front castors are equipped with a bracking mechanism.

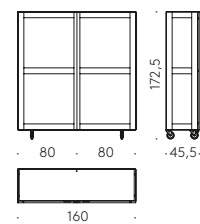

**Shigeto Box**—Vico Magistretti, 1990

Contenitore a giorno su ruote. Struttura e ripiani con parti in massello di rovere affumicato e parti in pannelli di particelle di legno impiallacciate in rovere affumicato. Ruote piroettanti. Le ruote anteriori sono dotate di un sistema di bloccaggio.

Open cabinet with castors. Frame and shelves in solid smoked oak, and in panels, veneered in smoked oak. Swivel castors. The front castors are equipped with a bracking mechanism.

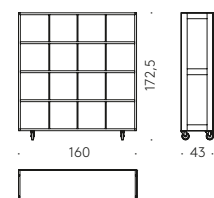

**Tani Moto**—Vico Magistretti, 1991

Libreria a giorno autoportante. Telaio in massello di rovere naturale o di noce canaletto con pannelli di legno impiallacciato in rovere naturale o noce canaletto. Schienale di fondo in multistrato impiallacciato in rovere naturale o in noce canaletto. Piani fissi in pannelli di particelle di legno impiallacciati in rovere naturale o noce canaletto. Piani spostabili e divisori verticali in MDF laccato colore bianco pelle d'uovo, solo per la versione in rovere, o impiallacciato in noce canaletto. Piedini regolabili.

Open free-standing bookcase. Frame in solid natural oak or Canaletto walnut, with panels in wood veneered in natural oak or Canaletto walnut. Back panel in birch plywood, veneered natural oak or Canaletto walnut, fixed shelves in natural oak or Canaletto walnut veneer, Movable shelves and vertical dividers in MDF lacquered in white eggshell, only for oak version, or in veneered Canaletto walnut. Adjustable feet.

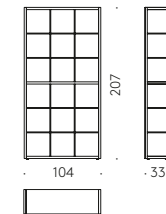

**Complementi**  
— Complementary items

**Art Wood Frame** — Piero Lissoni, 2019

Specchio con cornice. Struttura in MDF laccato nero opaco. Vetro riflettente extrachiaro argentato.

Mirror with frame. Black lacquered MDF frame. Reflective silver extra-clear glass.

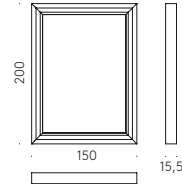

**Betulla** — Vico Magistretti, 1994/2016

Tavolino con cuscino. Base in acciaio cromato lucido. Piedini in termoplastica. Piano in multistrato di faggio impiallacciato in rovere affumicato. Optional: cuscino in memory foam e ovatta di poliestere, rivestito con vellutino di poliestere. Rivestimento sfoderabile in tessuto o in pelle.

Low table with cushion. Base in polished chromium-plated steel. Thermoplastic feet. Top in beech plywood, veneered in smoked oak. Optional: cushion in memory foam and polyester wadding covered by light polyester velvet. Removable cover in fabric or in leather.

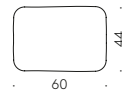
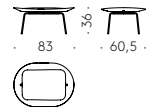

**Chab-table** — Nendo, 2005

Tavolino con vassoio. Base con acciaio verniciato color bianco o nero. Piedini in materiale termoplastico. Vassoio in multistrato di betulla rivestito in laminato HPL color bianco o nero con bordo in massello di faggio curvato e trattato a cera.

Low table with tray. Base in white or black coated steel. Thermoplastic feet. Tray in birch plywood covered with white or black HPL laminate, with edge in solid curved beech wood, treated with wax.

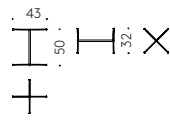
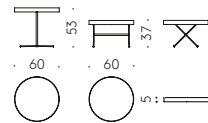

**Connecticut** — Jens Risom, 1965 — Edizioni De Padova

Coffee table. Struttura in massello di rovere tinto carbone. Piano in Marmo Bianco Carrara, Calacatta Oro, Valentine Grey o Grey Stone, trattato con prodotti idrorepellenti. Oppure in vetro temperato acidato retroverniciato color nero opaco.

Coffee table. Frame in solid charcoal-stained aniline-dyed oak. Top in White Carrara Marble, Calacatta Oro, Valentine Gray or Gray Stone, treated with water repellent products. Or in glass tempered, frosted, matt black back-painted.

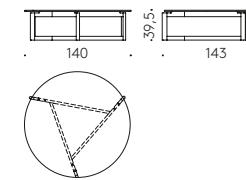
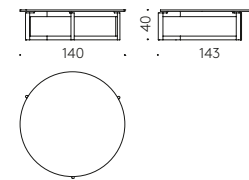
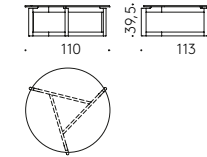
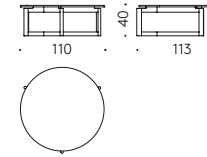

**Console** — 2003

Console. Base in massello di rovere naturale o tinto color wengé. Tiranti e trave inferiore in acciaio verniciato color alluminio o nero. Piano in pannello di particelle di legno impiallacciato rovere naturale o tinto color wengé.

Console table. Base in solid natural oak or wengé stained. Tie-rods and lower beam in coated steel, aluminium or black coloured. Top in particle board panel, veneered in natural oak or wengé stained.

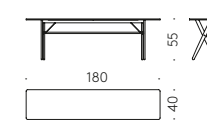
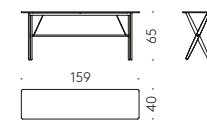

**Complementi**  
— Complementary items

**Dan** — Jørgen Møller, 1992

Tavolino rotondo e ovale. Gambe in estruso di alluminio verniciato color bianco opaco o nero opaco. Top: rotondo in MDF colore bianco o goffrato nero, oppure laminato HPL stratificato impiallacciato in noce canaletto. Ovale in MDF rivestito con laminato HPL bianco con bordo sagomato, oppure MDF con superficie nanotecnologica Fenix NTM® color nero opaco 'soft touch' con bordo sagomato; oppure in pannello di particelle di legno impiallacciato in noce canaletto con bordo sagomato in massello.

Low round and oval table. Legs in coated extruded aluminum, matt white or matt black coloured. Top: round in MDF, finished with white or embossed black. Or layered HPL laminate veneered in Canaletto walnut. Oval top in MDF covered with white HPL laminate with shaped edge. Or in MDF with Fenix NTM® nanotechnology surface in matt black 'soft touch' with shaped edge. Or with panel particle board veneered in Canaletto walnut with solid shaped edging.

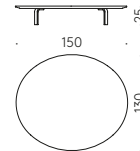
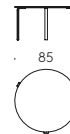
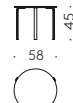
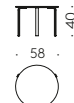
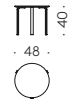

**Erei** — Elisa Ossino, 2018

Serie di tavolini. Tavolini in pannello in fibre di legno ad alta densità rivestito in cuoio pigmentato colore naturale, oppure impiallacciato in rovere affumicato. Piedini in acciaio verniciato color canna di fucile o color mattone.

Low tables in in black high-density wood fiber covered with pigmented cowhide natural matt colour or veneered in smoked oak. Feet in powder coated steel, gunbarrel grey or brick red coloured.

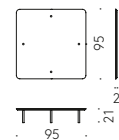
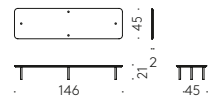
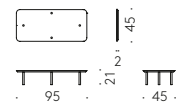
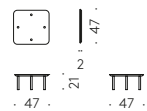

**Flying Landscape** — Piero Lissoni, 2019

Serie di tavolini. Base in lamiera di acciaio color grigio effetto grezzo e piedini in materiale termoplastico color ottone. Piani impiallacciati in rovere affumicato o rovere naturale, in Fenix NTM® nero opaco "soft touch". Oppure in marmo Bianco Carrara, Calacatta Oro, Valentine Grey, Grey Stone, Gris du Marais o Pietra d'Avola trattato con prodotti idrorepellenti.

Series of low tables. Low tables with base in grey, rough-effect steel sheet and thermoplastic feet, brass coloured. Tops veneered in smoked oak or natural oak, in Fenix NTM® matt black "soft touch". Or in Bianco Carrara, Calacatta Oro, Valentine Grey, Grey Stone, Gris du Marais or Pietra d'Avola treated with water-repellent products.

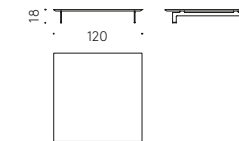
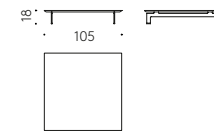

**Garderobier** — Lovorika Banovic, 2018

Servomuto a libro con tavolino/seduta. Struttura in acciaio verniciato color nero goffrato. Piedini e snodi in materiale termoplastico.

Folding clothes valet stand with table/seat. Structure in coated steel, fine embossed black colour. Thermoplastic feet and junctions.

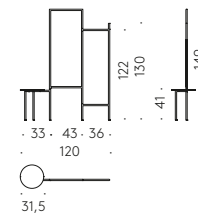

**Ishi** — Nendo, 2016

Tavolino basso. Base di undici elementi in massello di cedro libanese sagomato con forma arrotondata, differenti l'uno dall'altro, sei dei quali con peso in acciaio. Piano in vetro extrachiaro, spessore 12 mm, temperato, bordo a filo lucido.

Low table. Base consisting of eleven components in shaped solid Lebanese cedarwood, with varying and different rounded shapes. Weight in steel. Top in extra-clear tempered glass, 12 mm. thick. Polished edge.

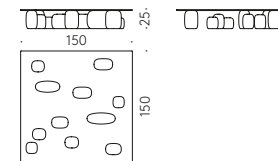



**Complementi**  
— Complementary items

**Mate** — Achille Castiglioni, 1992

Tavolino con base pieghevole e vassoio amovibile. Base pieghevole in massello di faggio naturale o massello di frassino color carbone. Cinghie in cotone di colore blu. Vassoio in massello di faggio naturale frassino tinto color carbone. Piano in multistrato di betulla impiallacciato in faggio naturale o impiallacciato in frassino tinto carbone.

Low table with folding base and removable tray. Folding in solid natural beech or solid ash wood, charcoal-coloured. Blue cotton straps. Tray in solid natural beech or solid ash wood, charcoal-coloured. Tray top in birch plywood, veneered in natural beech, or veneered in ash wood, charcoal-coloured.

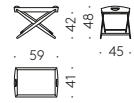

**Metallaro - Metallaro Indoor/Outdoor** — Studiocharlie, 2019

Tavolino. Struttura in lamiera di acciaio verniciata color bianco o nero o De Castelli délabré.

Low table. Frame in white or black painted steel sheet or De Castelli délabré.

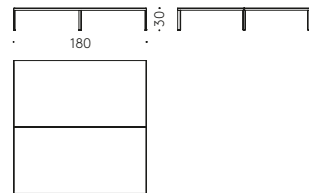

**Mini Mate** — Achille Castiglioni, 1993

Tavolino con base pieghevole e vassoio amovibile. Base pieghevole in massello di faggio naturale, o massello di frassino tinto color carbone. Cinghie in cotone di colore blu. Vassoio in massello di faggio naturale o in frassino tinto color carbone. Piano in multistrato di betulla rivestito in laminato bianco, o impiallacciato in frassino tinto color carbone.

Low table with folding base and removable tray. Folding base in solid natural beech or solid ash wood, charcoal coloured. Blue cotton straps. Tray in solid natural beech or in solid ash wood, charcoal-coloured. Tray top in birch plywood, or veneered in ash wood, charcoal-coloured.

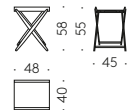

**Quadrato Espositore** — 1996/2016

Tavolino espositore quadrato. Struttura in tubolare quadrato di acciaio verniciato color bianco opaco o nero goffrato. Piano superiore in vetro extrachiaro, spessore 8 mm, temperato, con bordo filo lucido. Piano inferiore in pannello di particelle di legno nobilitato, bordato in ABS, color bianco opaco o nero opaco; oppure in marmo Bianco Carrara, Calacatta Oro, Gris du Marais, Pietra d'Avola o Greystone.

Low square display table. Frame in coated squared tubular steel, matt white or embossed black-coloured. Upper top in extra-clear tempered glass, 8 mm. thick. Polished edge. Lower top in melamine-coated wood particle board panel, with edges in ABS, matt white or black; or in white Carrara marble, Calacatta Oro, Gris du Marais, Pietra d'Avola or Grey stone.

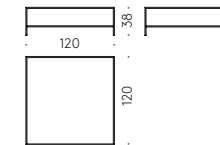
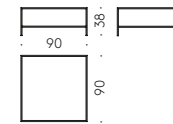

**Rokumaru** — Nendo, 2008

Appendiabiti. Struttura in massello di frassino con inserto in acciaio, sbiancato o tinto wengé. Piedini in termoplastica.

Coat hanger. Frame in solid ash wood with steel insert, bleached or wengé-stained. Thermoplastic feet.



**Sail** — Nendo, 2017

Tavolino. Base in acciaio verniciato color nero opaco. Piedini in termoplastica. Piano in multistrato di betulla impiallacciato in rovere affumicato con bordo in massello di rovere affumicato.

Low table. Base in steel, matt black coated. Thermoplastic feet. Top in birch plywood, veneered in smoked oak, edge in solid smoked oak wood.

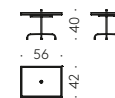

**Complementi**  
— Complementary items

**Scrittarello** — Achille Castiglioni, 1996

Tavolino, scrittoio. Base in massello di faggio naturale o in frassino tinto color carbone. Tiranti e trave inferiore in acciaio verniciato color alluminio o nero con poggiaiedi in materiale termoplastico. Piano e vassoio in multistrato di betulla rivestito in laminato HPL bianco o impiallacciati in frassino tinto color carbone.

Small table, writing desk. Base in solid natural beech or in ash, charcoal-coloured. Tie-rods and lower rod in coated steel, aluminium or black coloured, with thermoplastic footrest. Top and lateral shelves in birch plywood, covered with white HPL laminate or veneered in charcoal-coloured ash wood.

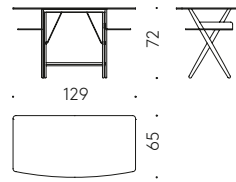

**Sen** — Kensaku Oshiro, 2016/2018

Serie di tavolini. Base in acciaio verniciato color grigio antracite. Piedini in termoplastica. Piano in legno: MDF nero impiallacciato in rovere affumicato o rovere naturale con nodi. Piano in Fenix NTM®: MDF nero rivestito con superficie nanotecnologica Fenix NTM® nero opaco "soft touch". Piano in marmo: marmo Bianco Carrara, Calacatta Oro, Gris du Marais, Pietra d'Avola, Grey Stone o Valentine Grey.

Series of low table. Base in Anthracite-grey steel coated. Thermoplastic feet. Wood top: in black MDF, veneered in smoked oak or natural oak with knots. Top in Fenix NTM®: in black MDF, covered with Fenix NTM® nanotechnology surface, matt black "soft touch". Marble top: in white Carrara marble, Calacatta Oro, Pietra d'Avola, Grey Stone, Gris du Marais or Valentine Grey.

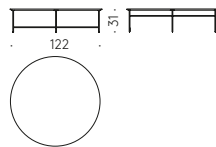
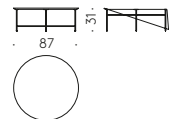
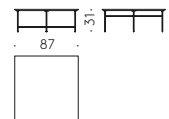
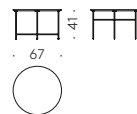
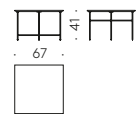
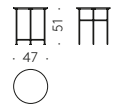
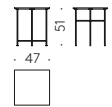

**SP14 Wood Frame** — neunzig° design, 2019

Specchio con cornice. Struttura in MDF laccato nero opaco. Vetro riflettente extrachiaro argentato.

Mirror with frame. Black lacquered MDF frame. Reflective silver extra-clear glass.

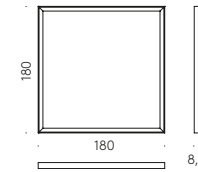

**Swiss 17** -- Mirco Zocca, 2003/2017

Tavolino regolabile in altezza. Base in acciaio cromato. Piedini in termoplastica nera. Top in MDF nero con bordo smussato, impiallacciato in rovere affumicato.

Low height-adjustable table. Base in Chromium-plated steel. Feet in black thermoplastic. Top in black MDF with rounded edge, veneered with smoked oak.

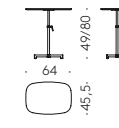
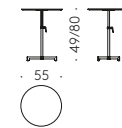

**Tetris** -- Nendo, 2007

Tavolino quadrato. Struttura in tubolare di acciaio a sezione quadrata, verniciato color bianco o nero. Piedini regolabili in materiale termoplastico. Piani in MDF con finitura goffrata, color bianco o nero.

Low square table. Frame in tubular square-sectioned steel, black or white coloured. Thermoplastic adjustable feet. Tops in MDF with embossed-finish, white or black coloured.

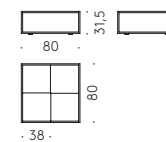

**Lampade**  
— Lamps

**Anna** — Paolo Tilche, 1962 — *Edizioni De Padova*

Lampada da tavolo. Struttura in metallo verniciato color nero. Paralume in policarbonato satinato bianco o in alluminio verniciato esternamente color nero e internamente color bianco. Luce a LED.

Table lamp. Frame in powder coated metal matt black-coloured. Lampshade in white satin polycarbonate or painted aluminium, black outside and white inside. LED light.

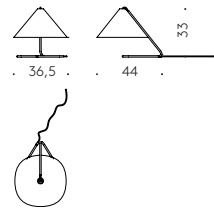

**Cielo-Terra** — Studiocharlie, 2017

Lampada da terra a soffitto (max. 3 mt). Struttura in tubolare in alluminio verniciato color bianco opaco o nero opaco con due barre integrate a LED.

Floor-to-ceiling lamp (max 3 mt). Frame in tubular in aluminium, matt white or matt black coloured, with two LED bars.

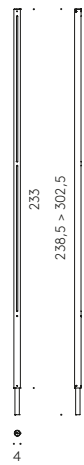

**Cilindri** — Elisa Ossino, 2019

Lampada da tavolo e a sospensione. Base in metallo verniciato nero. Cilindro esterno in Pirex trasparente e cilindro interno in Pirex sabbato. Luce a LED integrata.

Table lamp and pendant lamp. Base in black painted metal. External cylinder in transparent Pirex and inner cylinder in sandblasted Pirex. LED integrated lighting.

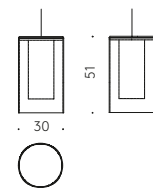
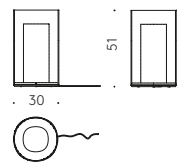

**DT Light** — Phil Luthlen, 2003

Lampada a sospensione. Struttura in alluminio anodizzato satinato. Paralume: Bianco in Pergamena (cellulosa, PVC).

Pendant lamp. Structure in satin anodised aluminium. Lampshade White in Parchment (cellulose, PVC).

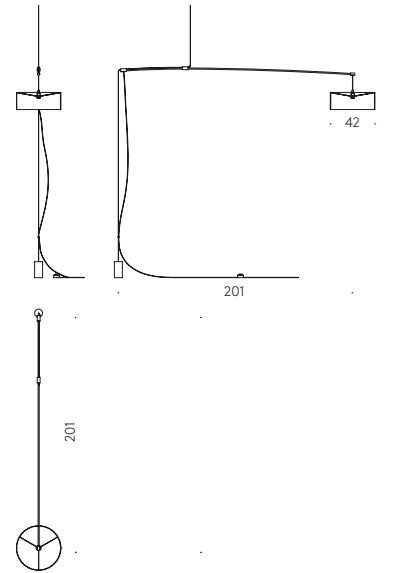
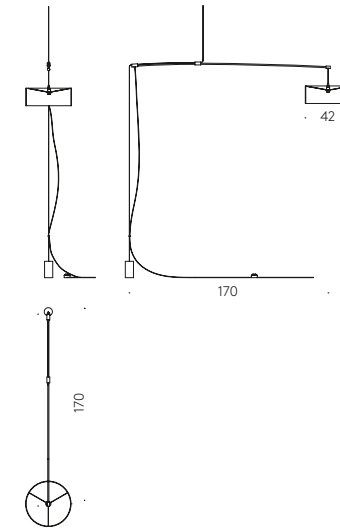
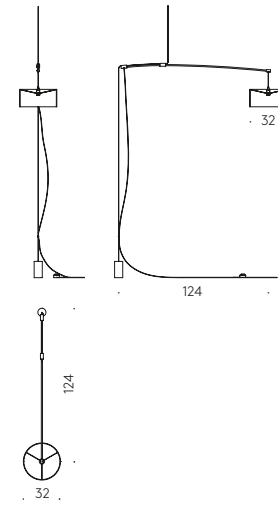

**Elementi** — Elisa Ossino, 2018/2019

Lampada a sospensione o da appoggio. Struttura in ottone verniciato color nero opaco. Diffusore in vetro soffiato opalino acidato. Luce a LED integrata.

Pendant or floor lamp. Frame in coated brass matt black-coloured. Diffusor in etched opal printed glass. LED integrated lighting.

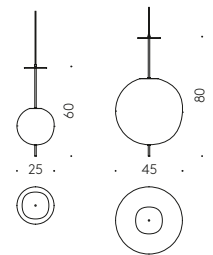
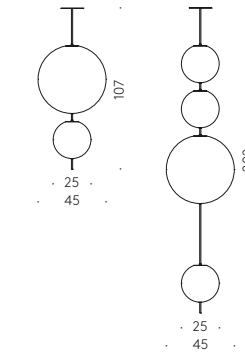
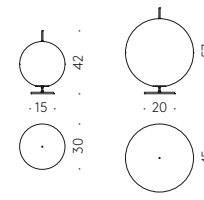

**Lampade**  
— Lamps

**Firefly** — Alexander Ahnebrink, 2016

Lampada portatile. Cestello portalampana in cuoio con fibbie cromate. Base in materiale termoplastico nero. Diffusore esterno in vetro stampato trasparente color grigio. Interno: vetro stampato trasparente acidato. Luce a LED integrata.

Portable lamp. Lamp carry holder in cowhide. Chrome-plated buckles. Base in Black thermoplastic. External Diffuser in Transparent moulded glass, grey-stained. Internal: frosted transparent moulded glass. LED integrated lighting.

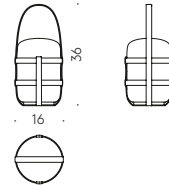

**Mogura** — Nendo, 2016

Lampada a sospensione o da terra. Struttura in tondino di acciaio verniciato color nero opaco. Portalampana in ceramica bianca.

Pendant or floor lamps. Structure in steel rod in matt black coated. White ceramic lamp holder.

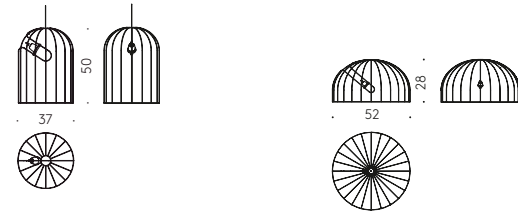
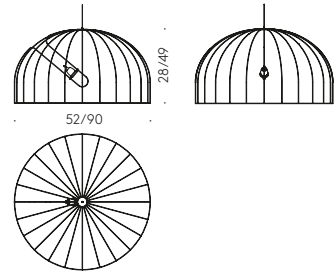

**Nota** — Elisa Ossino, 2017

Lampada da terra o da parete. Struttura in metallo verniciato color nero opaco. Diffusore in policarbonato opalino. Luce a LED integrata.

Floor or wall lamp. Frame in coated matt black steel. Diffusor in opal polycarbonate. LED integrated lighting.

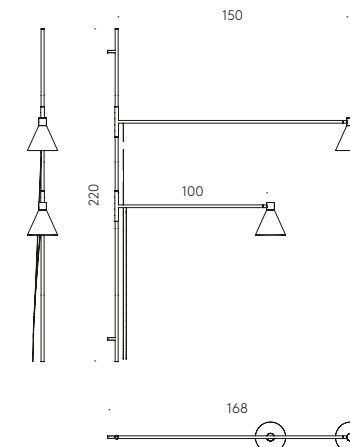
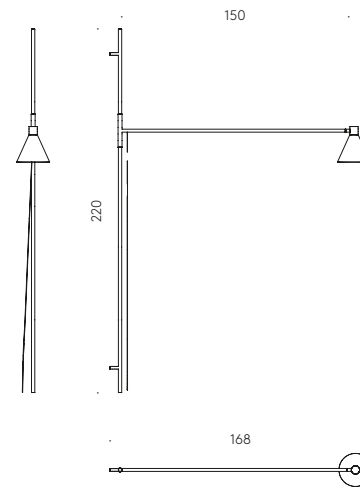
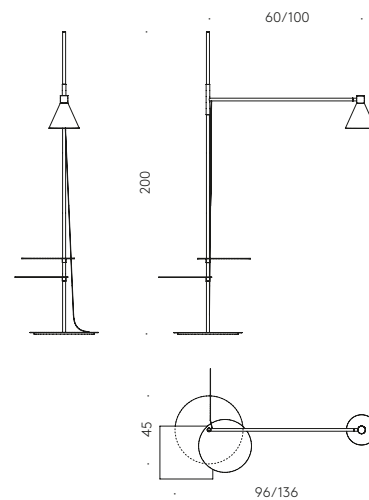
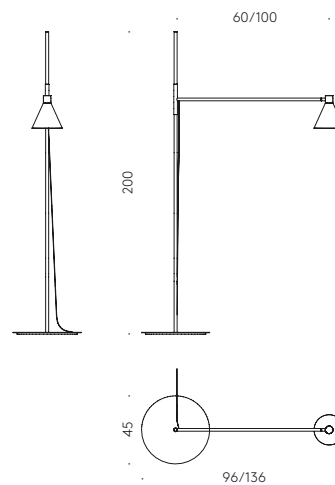

**Poet** — Keiji Takeuchi, 2018

Lampada a sospensione o da appoggio. Struttura in alluminio verniciato color nero opaco nella misura Ø 40, in grigio nella misura Ø 80. Diffusore in policarbonato bianco opalino. Luce a LED integrata.

Pendant or floor lamp. Structure in coated aluminium, matt black coloured for diameter 40 cm and grey for diameter 80 cm. Diffusor in opal white polycarbonate. LED integrated lighting.

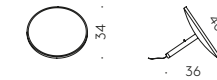
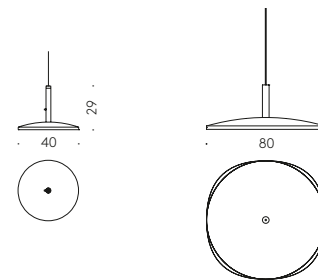

**Twig** — Keiji Takeuchi, 2017

Lampada da terra. Struttura in alluminio anodizzato nero opaco con sorgente luminosa ruotabile intorno al suo asse. Luce a LED integrata.

Floor lamp. Structure in matt black anodised aluminium with light source revolving on its axis. LED integrated lighting.

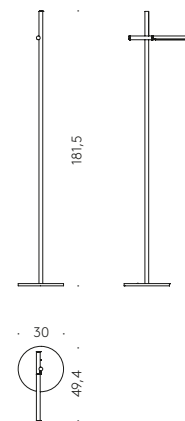

**Letti**  
— Beds

**Asseman** — Patrizia Cagliani, 1984

Letto matrimoniale a baldacchino, con ciellino o zanzariera. Struttura in tubolare d'acciaio verniciato color bianco opaco o nero opaco, con piedini regolabili. Testiera in pannelli di multistrato con imbottitura in poliuretano espanso, rivestiti con vellutino di poliestere. Piano ortopedico in multistrato di pioppo. Rivestimento sfoderabile in tessuto o fisso in velluto. A scelta: ciellino in cotone bianco stringato ai lati o zanzariera in tulle con bordi inferiore e superiore in cotone bianco. Materasso escluso 170x200.

Double canopy bed, with canopy or mosquito-curtain. Frame in coated tubular steel, matt white or matt black-coloured, with adjustable feet. Headboard in plywood panels padded by polyurethane foam and covered by light polyester velvet. Orthopedic base in plywood beech. Removable cover in fabric or non-removable in velvet. To be selected: white cotton canopy with laced up sides or mosquito-curtain in tulle with lower and upper edges in white cotton. 170x200 mattress not included.

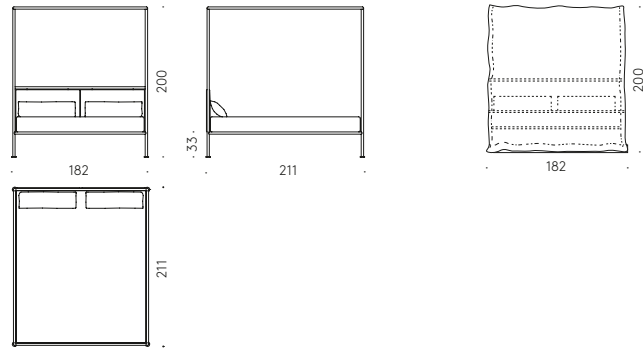

**Asseman Open** — Patrizia Cagliani, 2015

Letto matrimoniale con sommier. Struttura in tubolare d'acciaio verniciato color bianco opaco o nero opaco, con piedini regolabili. Testiera in pannelli di multistrato con imbottitura in poliuretano espanso, rivestiti con vellutino di poliestere. Sommier in multistrato imbottito con poliuretano espanso e rivestito con vellutino di poliestere. Rivestimento sfoderabile in tessuto o fisso in velluto. Materasso escluso 170x200.

Double bed with sommier. Frame in coated tubular steel, matt white or matt black-coloured, with adjustable feet. Headboard in plywood panels padded with polyurethane foam and covered by light polyester velvet. Sommier in class plywood, padded with polyurethane foam and covered by light polyester velvet. Removable cover in fabric or non-removable in velvet. 170x200 mattress not included.

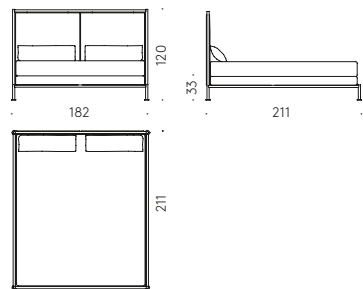

**Blendy** — Omi Tahara, 2019

Letto matrimoniale, matrimoniale queen size e king size. Testiera con struttura in acciaio e legno con imbottitura in poliuretano espanso a quote differenziate ed ovatta di poliestere, rivestito con vellutino di poliestere. Rete con doghe in multistrato di faggio naturale. Giroletto in legno rivestito con vellutino di poliestere. Rivestimento sfoderabile in tessuto, fisso in velluto o pelle. Materasso escluso: 153x203, 170x200, 180x200, 193x203.

Double bed, queen size and king size bed. Headboard frame in steel and wood with polyurethane foam padding in different densities and polyester wadding, covered by light polyester velvet. Base with slats in beech plywood. Wooden bed frame, covered with light polyester velvet. Removable fabric lining, non-removable in velvet or leather. Mattress not included: 153x203, 170x200, 180x200, 193x203

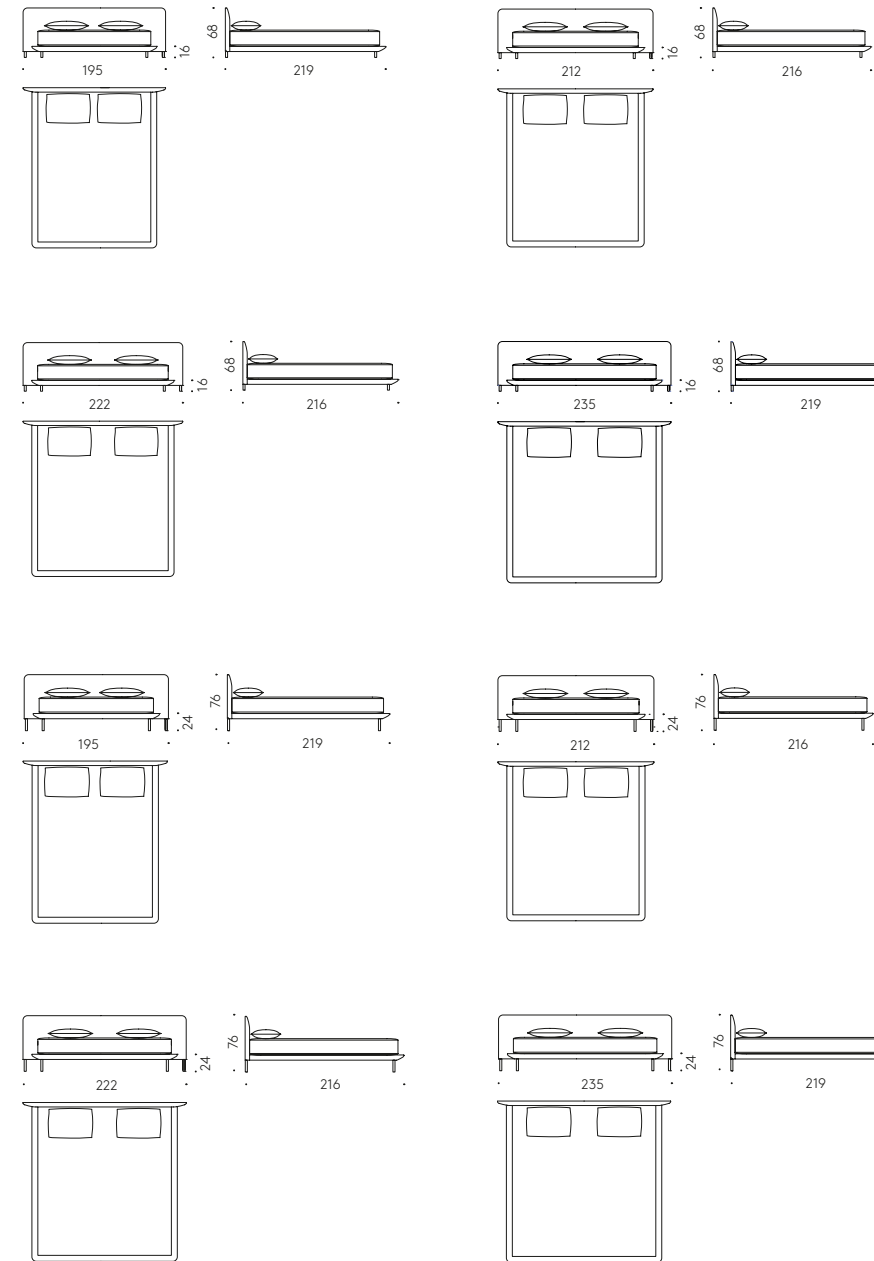



**Letti**  
— Beds

**Erei** — Elisa Ossino, 2018

Letto matrimoniale, matrimoniale queen size e king size. Struttura della testiera in legno. Piedini in acciaio verniciato color canna di fucile o color mattone. Imbottitura in poliuretano espanso a quote differenziate e ovatta di poliestere, rivestito con vellutino di poliestere. Struttura della base in acciaio e legno. Rete con doghe in multistrato di faggio naturale. Imbottitura in poliuretano espanso e ovatta di poliestere, rivestito con vellutino di poliestere. Rivestimento sfoderabile in tessuto o fisso in pelle o velluto. Materasso escluso: 153x203, 170x200, 180x200, 193x203.

Double bed, queen size and king size bed. Headboard with wooden structure. Feet in powder coated steel, gun barrel grey or brick red coloured. Variable-density foamed polyurethane padding and polyester wadding, covered by light polyester velvet. Bed frame in wood and steel. Base with beech plywood slats. Padded in foam polyurethane and polyester wadding, covered by light polyester velvet. Removable cover in fabric or non-removable in leather or velvet. Mattress not included: 153x203, 170x200, 180x200, 193x203.

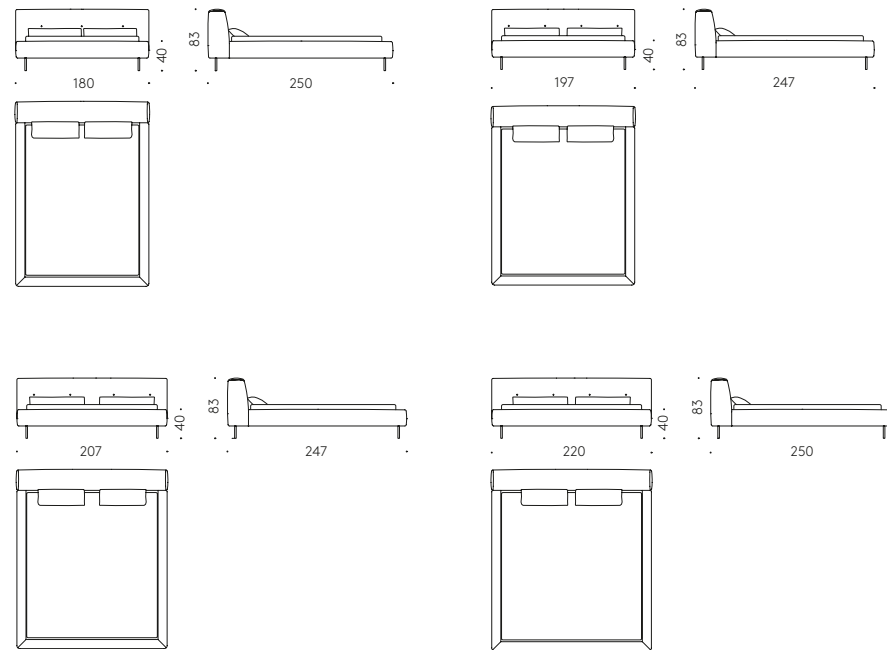

**Étiquette** — GamFratesi, 2019

Letto matrimoniale e matrimoniale king size. Struttura in metallo verniciato color nero opaco con barra posteriore in legno massello di frassino tinto color carbone. Rete con doghe in multistrato di faggio naturale. Cinghie in cuoio pigmentato colore naturale o color marrone. Cuscini della testiera in piuma d'oca con supporto in poliuretano espanso rivestito con tela di cotone. Rivestimento sfoderabile. Materasso escluso: 180x200, 193x203.

Double bed and king size bed. Frame in matt black painted metal with back bar in black stained solid ash wood. Base with beech plywood slats. Straps in mineral-tanned pigmented cowhide, natural or brown colour. Goose down cushions with polyurethane foam backing covered with cotton fabric. Removable cover in fabric or non-removable in leather or velvet. Mattress not included: 180x200, 193x203.

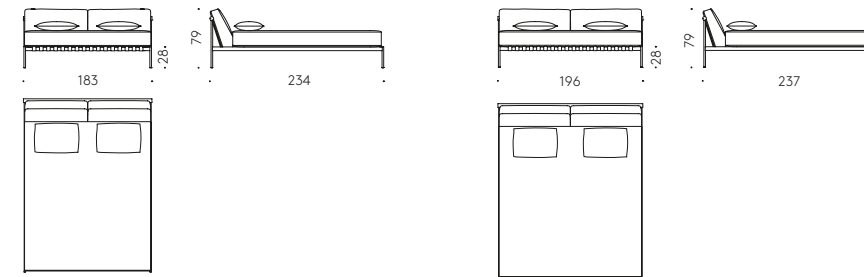

**Sleeping Car** — Vico Magistretti, 2004

Letto matrimoniale e matrimoniale king size. Testiera con struttura in acciaio e legno. Piedini regolabili verniciati color nero. Imbottitura in poliuretano espanso e ovatta di poliestere, rivestito con vellutino di poliestere. Base con struttura in acciaio. Doghe in multistrato di faggio. Giroletto in pannello di multistrato con imbottitura in poliuretano espanso rivestito con vellutino di poliestere. Rivestimento sfoderabile in tessuto o fisso in velluto o pelle. Materasso escluso: 170x200, 193x203.

Double bed and king size double bed. Headboard with steel and wood frame. Adjustable feet, black coated. Padding in polyurethane foam and polyester wadding covered by light polyester velvet. Frame in powder-coated steel. Slats in beech plywood. Bed frame in plywood panel, padded with polyurethane foam and covered by light polyester velvet. Removable cover in fabric or non-removable in leather. Mattress not included: 170x200, 193x203.

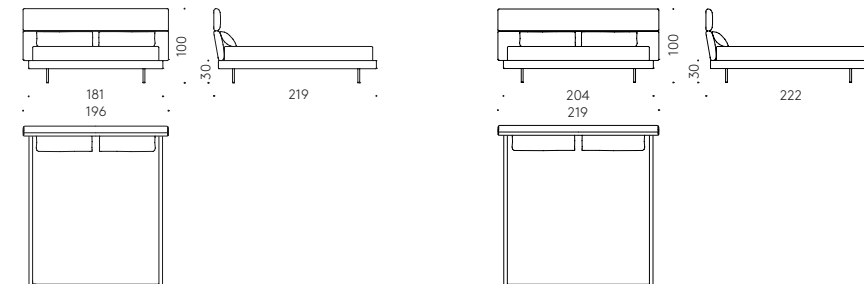



## Indice -- Index

**Connecticut**, J. Risom, 1965 -- *Edizioni De Padova*

Tavolino Low Table

**Chab Table** Nendo, 2005 -- Tavolino Low Table

**Console**, 2003 -- Console Console

**Dan** J. Møller, 1992/2015 -- Tavolino Low Table

**Erei** E. Ossino, 2018 -- Tavolino Low Table

**Flying Landscape** P. Lissoni, 2019 -- Tavolino Low Table

**Garderobier** L. Banovic, 2018 -- Servomuto Valet stand

**Ishi** Nendo, 2016 -- Tavolino Low table

**Madison**, 2018 -- Tappeto Rug

**Mate** A. Castiglioni, 1992 -- Tavolino Low table

**Mini Mate** A. Castiglioni, 1993 -- Tavolino Low table

**Metallaro** Studiocharlie, 2019 -- Tavolino Low table

**Quadrato espositore**, 1996/2018 -- Tavolino Low table

**Rokumaru** Nendo, 2008 -- Appendiabiti Coat hanger

**Sail** Nendo, 2017 -- Tavolino Low table

**Scrittarello** A. Castiglioni, 1996 -- Scrittoio Writing Desk

**Sen** K. Oshiro, 2016/2018 -- Tavolino Low Table

**SP14 Wood Frame** neunzig°design, 2019 -- Specchio Mirror

**Swiss 17** M. Zocca, 2003/2017 -- Tavolino Low table

**Tetris** Nendo, 2007 -- Tavolino Low table

**Tynn** -- Tappeto Rug

-- Lampade / Lamps

**Anna** P. Tilche, 1962 -- *Edizioni De Padova* -- Lampada Lamp

**Cielo-Terra** Studiocharlie, 2017 -- Lampada Lamp

**Cilindri** E. Ossino, 2019 -- Lampada Lamp

**DT Light** P. Luithlen, 2003 -- Lampada Lamp

**Elementi** E. Ossino, 2018/2019 -- Lampada Lamp

**Firefly** A. Åhnebrink, 2016 -- Lampada Lamp

**Mogura** Nendo, 2016 -- Lampada Lamp

**Nota** E. Ossino, 2017 -- Lampada Lamp

**Poet** K. Takeuchi, 2018/2019 -- Lampada Lamp

**Twig** K. Takeuchi, 2017 -- Lampada Lamp

**Poet** K. Takeuchi, 2018/2019 -- Lampada Lamp

-- Letti / Beds

**Asseman** P. Cagliani, 1984 -- Letto Bed

**Asseman Open** P. Cagliani, 2015 -- Letto Bed

**Blendy** O. Tahara, 2019 -- Letto Bed

**Erei** E. Ossino, 2018 -- Letto Bed

**Étiquette** GamFratesi, 2019 -- Letto Bed

**Sleeping Car** V. Magistretti, 2004 -- Letto Bed

-- Boffi

**L.O.P.** CRS Boffi, 2009/2012 -- Lampada Lamp

**Naviglio** P. Lissoni, 1995 -- Lampada Lamp

-- MA/U Studio

**C.O.P.** M. Harrsen, 2012 -- Contenitore Storage

**R.I.G. Modules** M. Harrsen, 2012/2019 -- Libreria Bookcase

pag: 24.25, 202.203, 209, 432.433, 436.437, 440, 441

pag: 2.3, 34.35, 90.91, 231, 367, 406.407, 460.461

pag: 410.411, 412

pag: 196.197, 199, 218.219, 221, 418.419

pag: 120.121, 128.129, 144.145, 442.443, 446.447

pag: 24.25,100.101, 104, 106.107, 111, 128.129, 152.153, 155, 156, 157

pag: 448, 449

pag: 182.183, 240.241

pag: 24.25, 56.57, 100.101, 106.107, 120.121, 128.129, 144.145, 202.203, 432.433,

442.443, 446.447, 450.451, 454.455

pag: 14.15, 426, 432.433

pag: 248.249, 422.423, 427

pag: 113

pag: 68.69, 96.97

pag: 410.411

pag: 14.15, 52.53, 100.101, 104, 106.107, 144.145, 150, 188.189, 202.203,

450.451, 454.455

pag: 414.415, 416, 417

pag: 10.11, 14.15, 16.17, 24.25, 42.43, 48.49, 56.57, 60.61, 68.69, 74.75,

100.101, 106.107, 120.121, 134.135, 188.189, 194.195, 201, 212.213,

428.429, 442.443, 446.447, 450.451

pag: 206, 207

pag: 42.43, 44, 64.65, 67

pag: 6.7, 228

pag: 168.169, 244.245, 248.249

pag: 380,381, 384.385, 387, 450.451, 454.455, 459

pag: 52.53, 54, 64.65, 67

pag: 103, 152.153, 155

pag: 352.353

pag: 24.25, 56.57, 58, 68.69, 100.101, 104, 106.107, 114.115, 116, 120.121,

128.129, 152.153, 155, 264.265, 271, 292.293, 326.327, 330.331, 332, 333, 361, 432.433,

436.437, 442.443, 446.447

pag: 428.429, 431

pag: 240.241, 334.335

pag: 14.15, 24.25, 28.29, 48.49, 50, 114.115, 134.135, 144.145, 188.189,

202.203, 414.415, 442.443, 446.447

pag: 74.75, 76, 78.79, 81, 308.309, 310

pag: 16.17, 23, 42.43

pag: 418.419, 420

pag: 422.423, 424, 428.429

pag: 432.433, 434, 435, 436.437

pag: 442.443, 444.445, 446.447

pag: 450.451, 452, 453, 454.455

pag: 460.461, 463

pag: 354.355

pag: 254.255

pag: 16.17, 19

pag: 24.25, 28.29,56.57, 64.65, 68.69, 74.75, 120.121, 144.145, 414.415,

432.433, 436.437

**Partners**

C&C

Noema Gallery

**Thanks to**

Altai

Anna Lerinder

Aparentment

Arte Nel Pozzo

Bitossi

Consolo Mario

Fil de Fer

Flos

Galleria Nicola Quadri

Gio Bagnara

Guido De Zan

HenryTimi

ImperfettoLab

Makers

Mamate

Memphis

Mmairo

Nude

Officine Saffi

Robi Renzi

Romina Gris

SG Gallery Milano

Solimene Art

Susan Phillips

The House of Vintage

Venini

When Objects Work

Yasha Butler

**Special agreements:**

Bonacina 1889

De Castelli

Salvatori

**Works by Elisa Ossino Studio**

pag. 6.7, 8.9, 34.35, 41, 42.43, 45, 50, 52.53, 64.65, 167, 168.169, 173, 182.183, 218.219, 221, 244.245, 248.249, 286.287, 289, 392.393, 394, 396.397, 410.411

**Works by Tomas Womb**

pag. 227, 229, 417, 422.423

**Courtesy of Daniele De Batté (Artiva Design)**

Modulo, 2018 — pag. 100.101

Modulo 2, 2018 — pag. 100.101

Modulo 3 (serie), 2018 — pag. 100.101

**Courtesy of Esh Gallery**

Kouzo Takeuchi, Modern Remains: Anchor, 2011 — pag. 144.145

Ōki Izumi, Losanga Dinamica, 2017 — pag. 442.443, 446.447

Yoichiro Kamei, Lattice receptacle A4(a), 2006

— pag. 326.327, 330.331

Yoichiro Kamei, Lattice receptacle relief D6, 2011 — pag. 74.75

**Courtesy of Federica Schiavo Gallery**

Todd Norsten, Basic Data, 2018 — pag. 384.385

Todd Norsten, Fumblina, 2018 — pag. 152.153, 155

Todd Norsten, Small Blue Steps, 2015 — pag. 114.115

Todd Norsten, Yellow Medicine, 2018 — pag. 152.153, 155

**Courtesy of Giuliano Cataldo Giancotti**

L'inevitabile progresso urbano, 2016 — pag. 16.17

Paesaggio meditativo, 2014 — pag. 96.97

Ricerca del sé, 2017 — pag. 14.15

**Courtesy of Grossetti Arte**

Giuseppe Spagnulo, Ferro spezzato, 1974 — pag. 134.135

Giuseppe Spagnulo, Studio per grande trappola, 1971 — pag. 56.57

Project / **Graph.X**  
Photo / **Tommaso Sartori**  
Styling / **Elisa Ossino Studio**  
Retouching Pre Press / **A. De Pedrini**  
Printed in Italy by **Grafiche Mariano 2019**

**De Padova srl**

Via Santa Cecilia, 7  
20122 Milano - Italia  
T. +39 02 27 43 97 1  
info@depadova.it  
www.depadova.com

**e DePadova®**

is registered trademark of

De Padova s.r.l.

© 2016 De Padova s.r.l.

All rights reserved. No part of this catalogue may be reproduced or transmitted in any form or by any means, electronic or mechanical, including printing, photocopying, recording, or any information storage and retrieval system without prior permission in writing from De Padova s.r.l., excepting reproduction intended to support the sale of De Padova products privately.

This catalogue is available free of charge subject to the condition that it shall not, by way of trade or otherwise, be sold or hired out totally or partly.



