

stella
1882

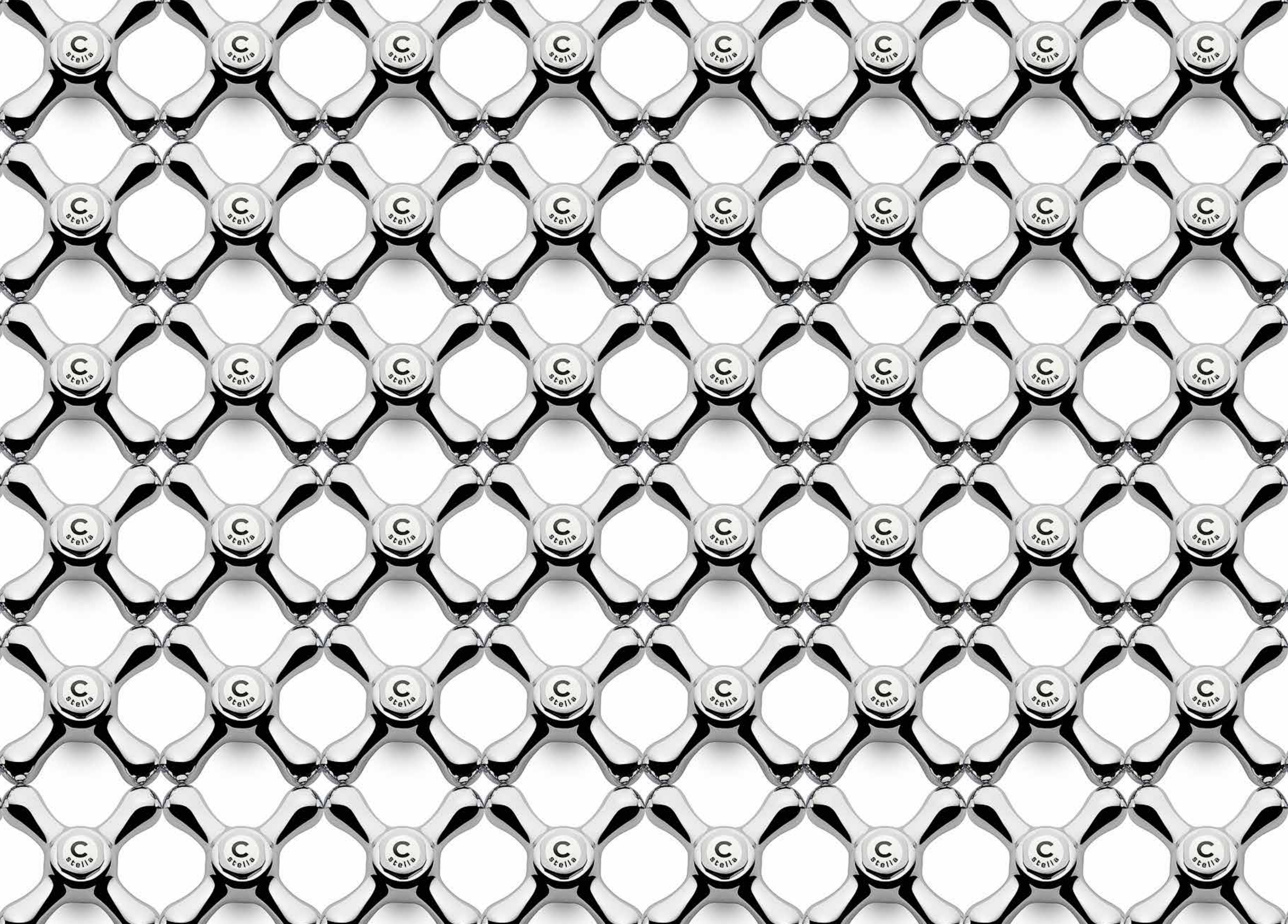

stella
1882

La tecnologia sola non è garanzia di lusso estremo perchè storia, qualità, raffinatezza, esclusività del prodotto sono valori imprescindibili del marchio Stella.

Technology on its own is not inevitably synonymic of Luxury. History, Quality, Refinement, and Exclusivity are fundamental values for Stella.

La Technologie seule n'est pas nécessairement synonyme de Luxe. L'Histoire, la Qualité, le Raffinement, et l'Exclusivité sont des valeurs essentielles de la marque Stella.

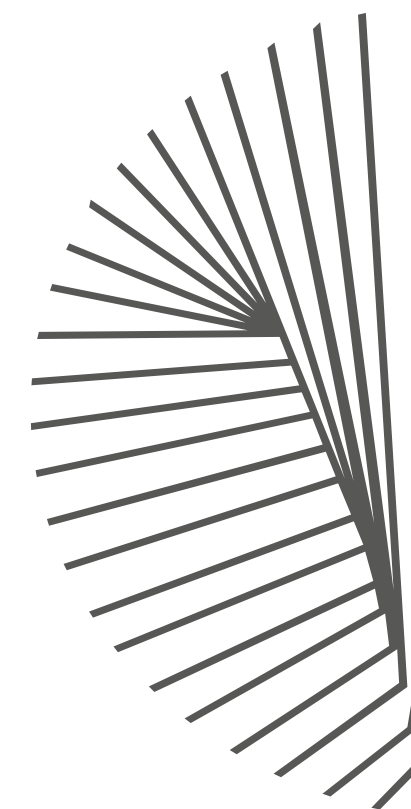

1882 - Sempre, rubinetti per sempre - Taps forever,

always - Toujours, robinets pour toujours - 2016



La nostra storia, il nostro futuro.

Our history, our future.

Notre histoire, notre avenir.

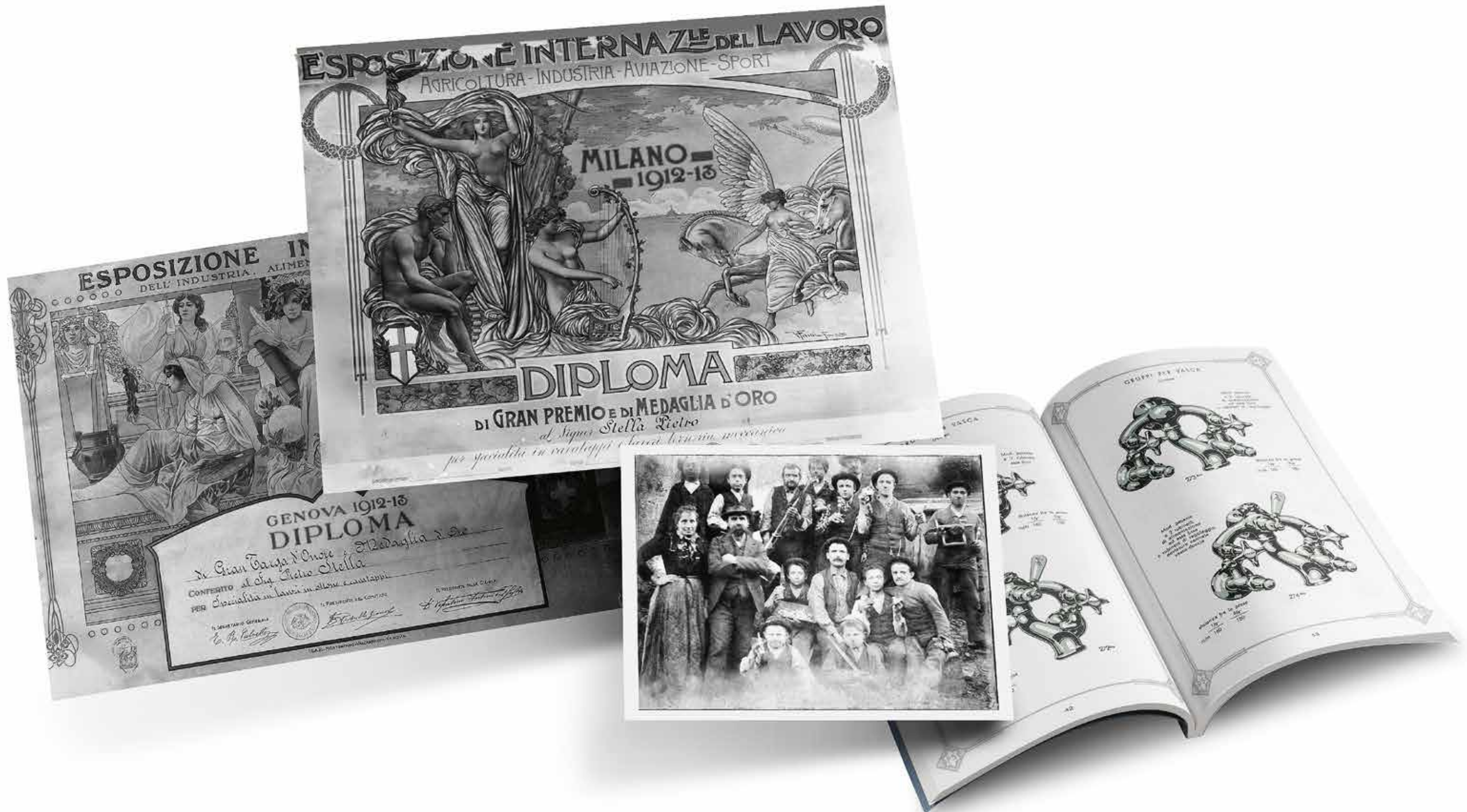

Immagini storiche dall'archivio aziendale
Photos from the company archives
Images d'archives de l'entreprise



Il primato del progetto

Conversazione con Pierluigi Nobili e Stefano Sappa

Lo storyboard è un racconto per immagini - normalmente disegni - usato dai registi per poter “vedere” il film prima della sua effettiva realizzazione.

In che senso avete sostituito il catalogo tradizionale con questo volume, definito appunto Storyboard?

Stefano Sappa:

Nel catalogo classico del nostro settore si punta sulla sensazione, sull’ambientazione, sull’impatto emozionale-estetico. Il prodotto viene di conseguenza in seconda battuta. Abbiamo fatto una scelta diversa: abbiamo privilegiato alcune immagini della nostra attività, concentrando l’attenzione sul ciclo produttivo, sul come e da chi è fatto il prodotto: dettagli di materiali, di lavorazione, della prova in acqua dei corpi a incasso, ad esempio. Come in un film o in un documentario.

Pierluigi Nobili:

Era nostra intenzione dare una prima idea immediata, attraverso la fotografia e la documentazione, delle nostre scelte tecniche e del nostro “modus operandi”. Con un dettaglio della ceramica, ad esempio, vogliamo sottolineare che siamo gli unici a continuare ad usare la porcellana nella doccetta.

Nella prima parte del volume è dato grande spazio alla realizzazione artigianale, manuale, pre-industriale, che l’azienda Stella aveva ai suoi albori. Quanto resta oggi di quel modo di produrre?

Stefano Sappa:

Della nostra ascendenza artigiana rimane sicuramente la libertà di dare priorità al progetto, al progettare: nella grossa tiratura il progetto è come tarpato in diversi suoi aspetti, perché si pensa già alla sua messa in produzione. In Stella invece tutto si plasma secondo il progetto: il rubinetto Titian di Michele De Lucchi con Philippe Nigro ha delle importanti complicazioni di lucidatura, non per questo si è abbandonata la sua realizzazione. Oppure si pensi alle forme di Firenze o a Casanova, forme che per le loro peculiarità non sono certamente destinate alle grandi tirature. In questo senso direi che siamo fieri di conservare un’anima artigiana.

Pierluigi Nobili:

Sono in linea con Stefano Sappa. L’eredità più grande che gelosamente custodiamo è la capacità di dare vita alla progettazione più ardita.

La capacità di plasmare manualmente integrando e andando oltre la macchina.

Vecchio e nuovo in Stella si armonizzano. Si pensi alla vicenda della serie Eccelsa.

Quando venne ripresa, dopo diversi anni di interruzione, venne riprodotta in tutto e per tutto la versione del 1929, conservando tutte le asperità realizzative - e con esse il fascino - di un disegno così datato.

Inoltre è stata prototipata la serie Vittoria del 1932 con maniglie in bachelite, pur scegliendo di non produrla in quel momento. In compenso sono state fatte nuove serie con le sinergie che Nobili ha potuto mettere a disposizione di Stella. Volevamo che Stella tornasse a fare ricerca com’è nelle sue corde.

Nel corso della sua storia, Stella ha avuto a che fare con nomi importanti del design internazionale, nomi che hanno contribuito alla sua fortuna disegnandone i prodotti. Proviamo a tracciare una linea evolutiva che colleghi le prime serie Stella alle ultime nate, quelle firmate Michele De Lucchi, alla ricerca di una essenza comune.

Stefano Sappa:

Io riconosco nelle varie serie una sorta di coraggio progettuale comune.

La ricerca di ergonomia e di proporzione che hanno reso eterna la serie Roma, il futurismo di Eccelsa, certe bocche disegnate da Carlo Santi, l’acquisto del brevetto Morisseu per realizzare con Box il primo rubinetto con azionamento joystick, il brevetto Protector per Aster o la ricerca di forme ispirate dalla natura come

il movimento curvo di Bamboo o la floralità di 130, fino ai terrazzamenti di Titian, la plasticità architettonica che va da Eccelsa del 1929 fino a Stella di Scacchetti passando attraverso Foster, Firenze e Casanova.

È come se ogni volta Stella fosse riuscita a farsi interprete dell’avanguardia progettuale. Tornando a Eccelsa,

ad esempio, ha saputo dare espressione a una forma e un’eco culturale, quelle del futurismo.

Non è dato sapere se sia stata l’idea di un designer o di un ufficio tecnico,

ma conta poco; è subito riconoscibile come prodotto Stella.

Pierluigi Nobili:

La mia storia personale e professionale è legata a doppio filo al rubinetto.

Ho sempre visto nel rubinetto Stella il rubinetto d’arte, l’opposto del rubinetto seriale in grandi tirature.

Titian è una scultura di De Lucchi prestata all’azienda.

Ho sempre visto Stella come il pioniere di tutto il distretto, l’innovatore, l’apripista che crea il pezzo unico.

L’acquisizione di Stella da parte del gruppo Nobili. Una scelta di cuore o di ragione? Cos’è cambiato, per Stella ovviamente, ma anche per Nobili, dopo l’acquisizione?

Pierluigi Nobili:

Direi tanto di cuore quanto di ragione. Il cuore ci ha fatto desiderare di provare a salvare un’azienda storica e la ragione ci faceva pensare che ce l’avremmo fatta. La nostra scelta è stata di non relegare Stella alla totale classicità ma di mantenerne l’essenza e fornirle i mezzi per creare qualcosa di nuovo.

Stella e Nobili hanno una cosa in comune: una produzione completamente interna, in totale autonomia. Stella ha potuto riappropriarsene proprio con l’acquisizione Nobili, azienda che ha potuto dotarla di quanto in quel momento le mancava.

Nel volume che De Agostini ha dedicato a Stella e alla storia dell’ingegno italiano nel Novecento si cerca di capire, discutendone con designer e architetti contemporanei, il segreto di un prodotto che resta in produzione a lungo, sopravvivendo a mode e tempi. Centro di questa discussione proprio le serie Stella Roma, Italica ed Eccelsa. Dove credete si trovi la magia di un rubinetto identico a se stesso da quasi cent’anni?

Stefano Sappa:

Direi in una perfetta combinazione fra funzionamento e bellezza.

Il rubinetto a vitoni meccanici funziona in qualsiasi condizione, a lungo, in modo ecologico,

e la scelta fra acqua fredda e calda è una scelta intuitiva.

Quanto alla bellezza, una bella donna della Belle époque sarebbe indiscutibilmente una bella donna anche oggi.

Pierluigi Nobili:

Talvolta mi capita di pensare alle microtrasformazioni che ha avuto la serie Roma negli anni, consolidando una propria essenza unica, inimitabile. Una proporzione perfetta.

Nel nostro settore, come in altri, normalmente si progetta una serie nuova valutando le linee di

tendenza del mercato e creando il rubinetto di conseguenza; nella Roma, indifferente a tutto

questo, è la durata che resiste agli anni, al tempo, un’idea che continua a realizzarsi ed affermarsi.

stella
1882

Top Class Design (An interview with Pierluigi Nobili and Stefano Sappa)

Storyboards are basically a large comic strip – a series of pictures – that help directors “see” what their film will look like once it’s finished. What made you come up with the idea of dispensing with a tradiional catalogue and opting instead for this volume that you’ve entitled “Storyboard”?

Stefano Sappa: In our business, catalogues are invariably packed with stunning settings meant to take the client’s breath away; the photos are a blatant attempt to impress. The product is virtually an afterthought. We’ve taken the opposite tack. To start with there are a few pictures of the factory. We’ve focussed on our manufacturing process because we want to show how the product is actually made, and the people who make it. There are pictures of materials, processes, water tightness testing, for instance. It’s more like a film or a documentary.

Pierluigi Nobili: We were looking for a combination of words and pictures to tell the story of how we “do things” and explain, visually, why we make certain technical decisions. The concept we’re getting across in one close-up shot, for instance, is that we are the only manufacturers left who actually still use porcelain for shower heads.

The first half of the book is all about Stella’s beginnings, in the very early days, when your products were hand-made by master craftsmen. What have you preserved of that traditional approach?

Stefano Sappa: One thing we have never given up is our freedom to concentrate on design and the design process. In large-scale manufacturing, the original design is often tweaked to within an inch of its life, because the focus is always on streamlining the assembly line. Whereas Stella never, ever loses sight of the design. The Titian faucet created by Michele De Lucchi with Philippe Nigro is a nightmare to polish, but that challenge certainly didn’t hold us up. Not to mention the shape of the Firenze or the Casanova: there’s simply no way those designs could ever be turned out of an assembly line. In that respect it’s safe to say we are truly proud of our craftsman roots.

Pierluigi Nobili: I couldn’t agree more with Stefano. One of our most closely cherished legacies is that we never shy away from designs that many would call daring, to put it mildly. We understand where the limits of machinery lie, and have a flair for getting expert human hands to do certain jobs. At Stella, the old and the new coexist in perfect harmony. The Eccelsa range is a case in point. It went out of production long ago, but we decided to reproduce the 1929 version exactly as it was, ‘warts and all’. And of course leaving the old-fashioned charm of that design absolutely intact. We’ve also prototyped the Vittoria set from 1932, with its lovely Bakelite handles, but it’s on the back burner for the time being. However, we’re also looking ahead. And major synergies are developing between Nobili and Stella. Stella has research in its blood, and we are determined to make research a priority again.

Throughout its history, Stella has partnered some of the world’s leading designers, whose brilliant work helped to build the company’s success. Stella’s earliest product ranges are inextricably bound to the latest ones designed by Michele De Lucchi, insofar as they are driven by the same quintessential aspirations.

Stefano Sappa: To me, the designs all share the same fearlessness and daring. Ergonomics and the search for perfect proportions are what make the Roma series timeless. Not to mention the avant-garde Italian art movement of the early 20th century, Futurism, that’s instantly recognizable in the Eccelsa range, as well as certain spouts designed by Carlo Santi. Stella acquired the Morrisseau patent to make Box, which was the first faucet to feature a joystick mixing cartridge, and the faucet protector patent for the Aster. Mother nature inspired the gentle curves of the Bamboo series and the floral stylings of the 130. Which brings us to the step-pyramid shape of the Titian range, and the architecturally graceful lines of the Eccelsa, created in 1929, right down to the Foster, Firenze and Casanova, and eventually, the Stella series designed by Luca Scacchetti. Every step of the way, Stella has somehow managed to stay ahead of the curve, with designs that are invariably on the cutting edge. Going back to the Eccelsa, for example: here is a range that perfectly embodies the cultural look and feel of Futurism. It matters little whether it was created by a celebrated world class designer or a local artisan. There’s no mistaking the distinctive Stella style.

Pierluigi Nobili: Funnily enough, faucets have played a crucial role in my career and in my personal life. I’ve always viewed the Stella faucet as a design object that has absolutely nothing in common with mass-produced faucets. Titian is a sculpture that the company borrowed from De Lucchi... I have always admired Stella’s pioneering spirit. People around here see them as innovators, as ground breakers always out to create something unique.

What about Stella’s takeover by the Nobili Group: was that a decision that came from the heart or was it a rational move? The acquisition must have meant changes for Stella, but what about Nobili?

Pierluigi Nobili: I’d say the decision was both emotional and rational. Our heart was telling us to try and rescue this landmark company, and our business acumen was saying we should, and could, take it over. However, Stella was not going to be synonymous only with classic styles: we were keen for its essence to be preserved, and we will provide the resources it needs to think out of the box. There’s one thing that Stella and Nobili share, which is that they both manufacture entirely in-house, but independently. With the acquisition, Nobili gave Stella what it needed to re-insource all of its manufacturing processes.

The volume published by DeAgostini about Stella and the history of 20th Century Italian manufacturing ingenuity includes interviews with contemporary Designers and Architects and explores the secrets of a product that has outlived passing fads and fashions, and is still proudly in production. You’re probably referring to Stella’s Roma, Italica and Eccelsa ranges. What explains the enduring popularity of these faucets, which haven’t changed in almost a hundred years?

Stefano Sappa: I think it’s because they offer the perfect balance of attractiveness and function. Faucets using chunky mechanical screws will endure the harshest conditions, they’re environmentally friendly, and the choice of hot and cold water is intuitive. And they’re lovely. The way beauty was defined at the turn of the century, at the height of the Belle Époque, hasn’t changed altogether that much since then.

Pierluigi Nobili: I sometimes think about how the Roma range has changed ever so slightly over the years, without ever forgoing its character. Its proportions are utterly flawless. In most businesses, the latest market trends are generally what drive the roll-out of a new range. The same goes for faucets. But the Roma is impervious to the passing of time. The Roma is what it is, and its enduring popularity proves that there’s no need for any nipping and tucking.

La primauté du projet (Conversation avec Pierluigi Nobili et Stefano Sappa)

Le story-board est une histoire en images – souvent dessins - utilisé par les cinéastes pour pouvoir être en mesure de «voir» le film avant sa réalisation. Comment avez-vous eu l'idée de substituer un catalogue traditionnel par ce volume, intitulé Story-board?

Stefano Sappa: Dans le catalogue classique de notre production, nous mettons l’accent sur la sensation, sur le cadre, sur l’impact émotionnel et esthétique de nos produits. Le produit en est le résultat. Nous avons fait un choix différent: nous avons privilégié quelques images représentatives de notre activité, mettant l’accent sur le cycle de production, sur le « comment » et « par qui » le produit est fait: détails sur les matériaux, sur l’usinage, sur les tests dans l’eau des éléments techniques internes, par exemple. À la façon d’un film ou dans un documentaire.

Pierluigi Nobili: Notre intention était de donner une première idée qui soit immédiate, à travers des photographies et divers documents, de nos choix techniques et de notre «modus operandi». Par exemple avec un focus sur la céramique, nous tenons à souligner que nous sommes les seuls qui continuent à utiliser la porcelaine sur le pommeau de douche.

Dans la première partie de l’ouvrage une grande place est consacrée au travail artisanal et manuel, de l’époque préindustrielle, que Stella avait à ses débuts. Que reste-t-il aujourd’hui de ce mode de production?

Stefano Sappa: De nos aïeux artisans demeure certainement la liberté de donner la priorité au projet et à la conception: dans la grande série, le projet est soumis à de fortes restrictions pour faciliter sa mise en production finale. Chez Stella, au contraire, tout est façonné en fonction du projet: le robinet Titian de Michele De Lucchi et Philippe Nigro révèle d’importantes difficultés lors du polissage, mais ce n’est pas pour cela que le projet a été abandonné. Si nous pensons aux collections Firenze ou Casanova, leur formes sont particulières et ne sont certainement pas destinées à de grandes séries. En ce sens, je dirais que nous sommes fiers de maintenir une âme artisanale.

Pierluigi Nobili: Je suis d’accord avec Stefano Sappa. Le plus grand héritage, que nous conservons jalousement, est sans doute la capacité de soutenir les parti-pris des plus audacieux. Également celle de façonner et d’adapter manuellement, d’aller au-delà du travail automatisé. Chez Stella, ancien et nouveau s’harmonisent. Pensons à l’histoire de la collection Eccelsa. Quand elle fut rééditée, après plusieurs années d’interruption, elle fut reproduite en tous points identique à la version de 1929, en conservant toutes les difficultés de réalisation et avec eux le charme d’un dessin ancien. Fut également prototypée la série Vittoria de 1932 avec ses poignées en bakélite, même si le choix fut de ne pas la fabriquer, pour le moment. D’autre part ont été réalisées des collections grâce à la synergie que Nobili à pu mettre à disposition de Stella. Nous voulions que Stella puisse à nouveau faire les recherches et expérimentations qui la caractérisent.

Tout au long de son histoire, Stella a côtoyé des noms importants du design international, des noms qui par l’intermédiaire du dessin de leur produits, ont contribué à son succès. Essayons de tracer une ligne qui ferait le lien entre les premières collections Stella et les dernières nées, celles dessinées par Michele De Lucchi. Allons à la recherche de leur essence commune.

Stefano Sappa: Je reconnais dans les diverses séries une sorte de courage commun dans la façon de concevoir. La recherche de l’ergonomie et des proportions qui ont rendu la série Rome éternelle, le futurisme d’Eccelsa, certaines pièces conçues par Carlo Santi, l’achat du brevet Morisseu pour réaliser avec Box le premier robinet avec fonctionnement à manette, le brevet Protector pour Aster ou la recherche de formes inspirées par la nature comme le mouvement courbe de Bamboo ou la forme florale de 130, jusqu’aux terrasses de Titian, la plastique architecturale qui va de Eccelsa en 1929 à Stella de Scacchetti en passant par Foster, Firenze et Casanova. C’est comme si pour chaque projet Stella avait été un interprète de l’avant-garde créative. Pour en revenir à Eccelsa, par exemple, elle a réussi à donner une expression à une forme et un écho culturel, qui sont ceux du futurisme. On ne sait pas s’il s’agit de l’idée d’un designer ou d’un bureau d’étude, mais peu importe: elle est immédiatement reconnaissable comme un produit Stella.

Pierluigi Nobili: Mon histoire personnelle et professionnelle est très étroitement liée au domaine de la robinetterie. J’ai toujours considéré le robinet Stella comme un robinet d’art, à l’opposé du robinet de grande série, Titian est comme une sculpture que De Lucchi aurait « prêtée » à la Stella. J’ai toujours vu Stella comme un pionnier dans l’ensemble de notre secteur, innovant et précurseur, capable créer des pièces d’exception.

L’acquisition de Stella par le groupe Nobili. Un choix de cœur ou de raison? Qu’a changé cette acquisition, bien sûr, pour Stella, mais aussi pour Nobili?

Pierluigi Nobili: Je dirais autant de cœur que de raison. Le cœur a permis que nous ayons eu l’envie de sauver une entreprise historique et la raison nous a confirmé que nous en aurions été capables. Notre choix a été celui de ne pas reléguer Stella qu’au classicisme, mais d’en préserver l’essence tout en lui donnant les moyens de créer quelque chose de nouveau. Stella et Nobili ont une chose en commun: une production gérée de façon interne, en totale autonomie. Stella a pu reprendre possession d’elle-même grâce à l’acquisition de Nobili, une entreprise qui a pu lui subvenir quand ceci fut nécessaire.

Dans le livre que De Agostini a dédié à Stella et a l’histoire du génie italien au XXe siècle, il est question de chercher à comprendre, au travers de discussions avec des designers et des architectes, le secret qui fait qu’un produit reste en production pendant très longtemps, imperméable aux modes et au temps. Au cœur de cette discussion, les collections Roma, Italica et Eccelsa. Un robinet presque centenaire, sans une ride, comment cette magie est-elle possible?

Stefano Sappa: Je dirais que cette magie est possible grâce à une combinaison parfaite entre fonction et beauté. Le robinet mécanique avec système de vis, fonctionne dans n’importe quelles conditions, pendant longtemps, d’une manière respectueuse de l’environnement, faisant que le choix entre eau chaude et eau froide soit un choix intuitif. Quant à la beauté, une belle femme de la Belle Époque serait incontestablement une belle femme aujourd’hui.

Pierluigi Nobili: Parfois il m’arrive de penser aux micro-transformations qu’a eues la collection Roma au cours du temps, consolidant sa propre essence, unique, inimitable. Une proportion parfaite. Dans notre secteur d’activité, comme dans d’autres d’ailleurs, normalement lorsque vous concevez une nouvelle collection, vous tenez compte des lignes et des tendances du marché : la collection Roma est indifférente à cela, seule sa capacité à traverser les époques s’affirme et lui permet de rester aujourd’hui encore, actuelle et bien vivante.

stella
1882

Rubinetti
aristocratici,
inimitabili,
unici

Luxurious,
inimitable
and unique
taps

Des robinets
luxueux,
inimitables
et uniques



Made in Italy- Qualità Totale
Made in Italy – Total quality
Made in Italy – Qualité totale



Artigianalità
Craftsmanship
Artisanat



Materiali nobili
Noble materials
Matériaux nobles

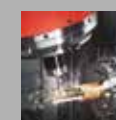

Tradizione - Innovazione
Tradition - Innovation
Tradition - Innovation



Lavorazioni esclusive
Exclusive workmanships
Fabrications exclusives



Finiture
Finishing
Finitions

Made in Italy

Il Catalogo certifica la produzione totale "Made in Italy", a garanzia di rubinetti esclusivi

The Catalogue certifies a total "Made in Italy" production, in order to guarantee exclusive taps

Le Catalogue certifie une production totale « Made in Italy », garantissant des robinets exclusifs



Materiali nobili

Noble materials

Matériaux nobles

Bronzo

Il bronzo è materiale antico e pregiato, da tempi remoti usato nella costruzione degli acquedotti come pure nelle valvole delle tubature di piombo nelle città dell'antica Roma.

Ritrovamenti di manufatti in bronzo negli scavi archeologici dimostrano che, a distanza di duemila anni, ha mantenuto inequivocabili eccezionali caratteristiche di duttilità e resistenza alla corrosione. Per questo Stella, unica nel panorama delle rubinetterie, mantiene ed impiega fusioni in bronzo per le parti ad incasso dei propri rubinetti, garantendo durata illimitata nel tempo.

Bronze

Bronze is a metal that has been prized throughout history. It was used in ancient Rome to construct aqueducts and for the valves in lead pipes.

Archeological finds prove that even after two thousand years, bronze retains its ductility and corrosion-resistance. This is why Stella is the only Italian faucet-maker that still uses bronze castings for parts used behind the wall, guaranteeing they will last forever.

Bronze

Le bronze est un matériau antique et précieux, depuis l'antiquité utilisé dans la construction des aqueducs ainsi que dans la fabrication des valves des tuyaux en plomb, dans les villes de la Rome antique.

La découverte d'objets en bronze lors de fouilles archéologiques démontre que même après deux mille ans, il conserve sans équivoque son exceptionnelle qualité ductile et de résistance à la corrosion. Pour cela Stella, la seule entreprise dans le secteur de la robinetterie, maintient l'utilisation de la fonte de bronze dans la fabrication des pièces encastrées, de ses robinets, garantissant ainsi une durée illimitée dans le temps.

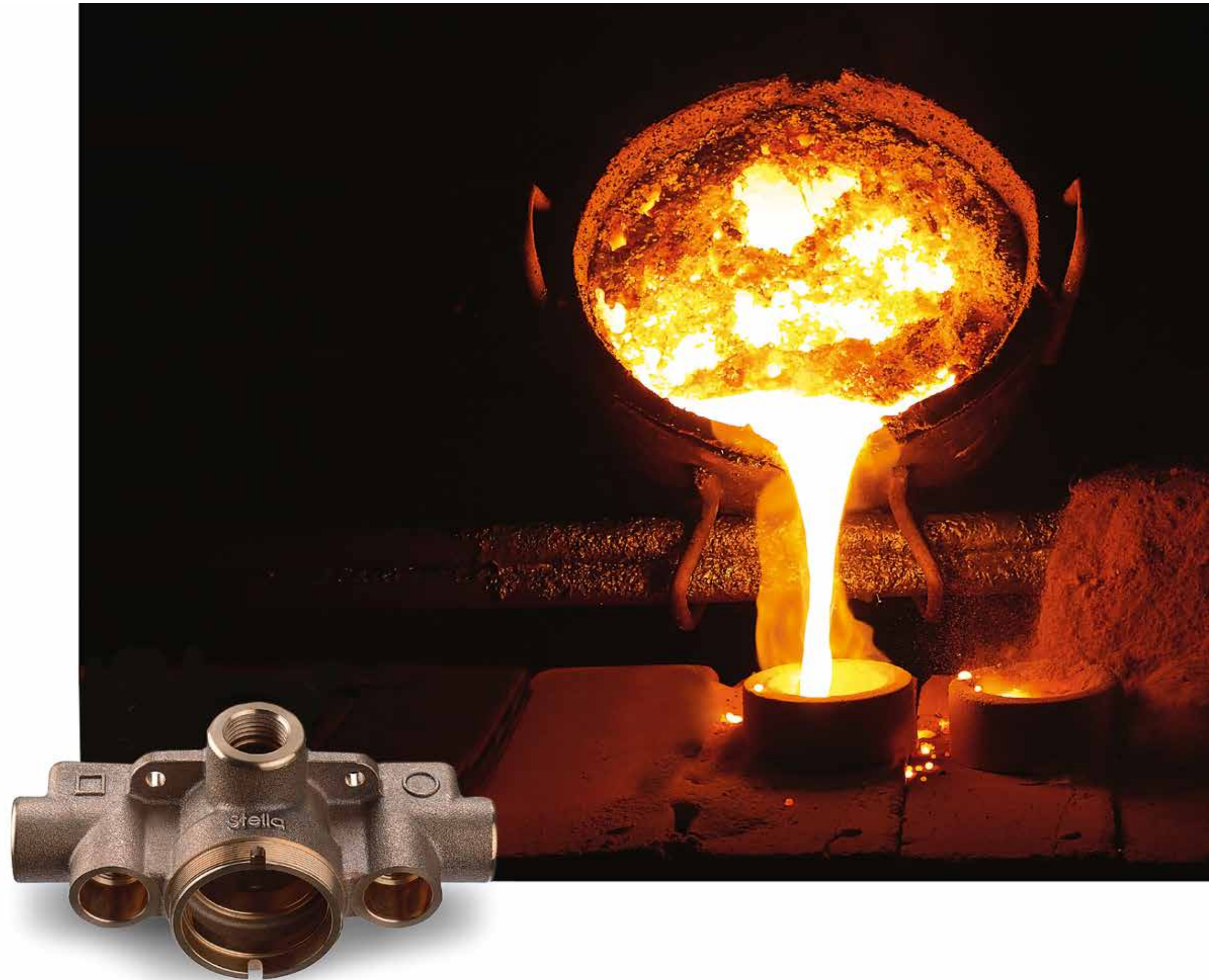

Artigianalità
Craftsmanship
Artisanat

Da sempre nei processi produttivi l'artigianalità ha contraddistinto la storia di Stella

Within the Production processes, craftsmanship has always countersigned the History of Stella

Depuis toujours dans les processus de production, l'artisanat a marqué l'histoire de Stella





Tradizione - Innovazione

Tradition - innovation

Tradition - innovation

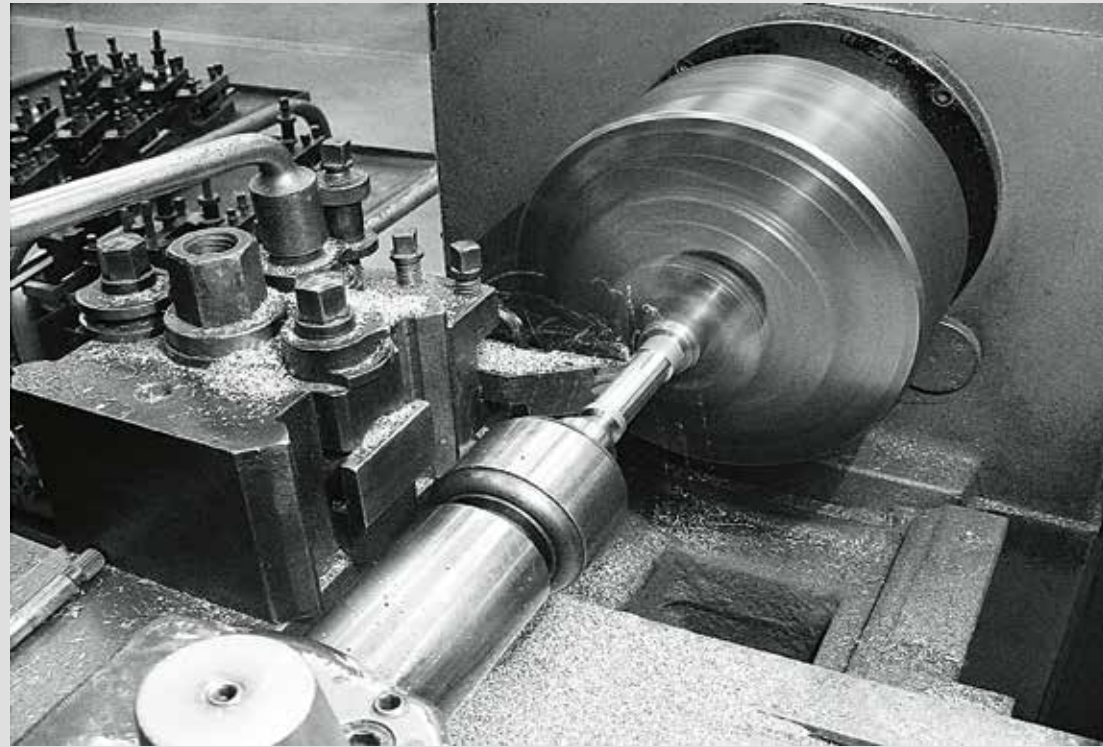

Tradizione - Per la produzione di componenti di rubinetti di forniture particolari e speciali, si utilizzano a tutt'oggi macchine utensili di eccezionale precisione gestite manualmente

Tradition - To craft our special finished taps' components, we use extraordinarily precise machines, manually controlled

Tradition - Pour la production des composants de nos robinets aux finitions spéciales, nous utilisons des machines-outils d'une précision exceptionnelle pilotées manuellement.



Innovazione - Lavorazioni dell'ottone robotizzate per un prodotto finale perfetto.

Innovation - Robotic workmanships of the brass for a perfect final product.

Innovation - Un travail du laiton entièrement robotisé pour un produit final parfait.

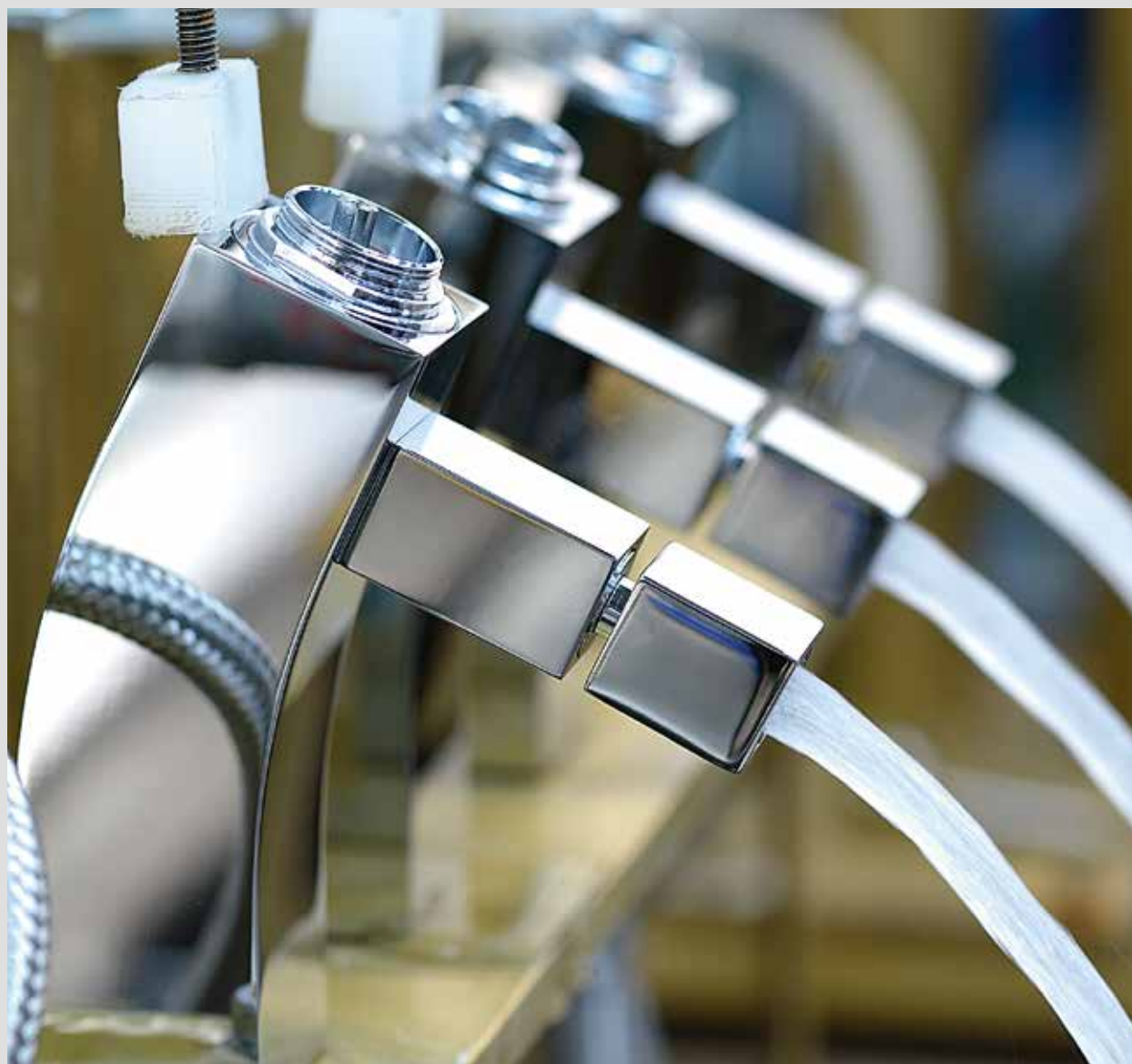

Prima della vendita ogni miscelatore è collaudato con acqua a pressioni differenziate

All mixers are tested at different water pressure before sale

Avant leur mise en vente, les mitigeurs sont soumis à des tests à l'eau sous différentes pressions.



Gli incassi in bronzo, testati ad acqua in immersione, sono garantiti a vita

The bronze embedded parts, water tested by dumping, are Life-guaranteed.

Les parties encastrées en bronze, testées à l'eau en immersion, sont garanties à vie.



Lavorazioni esclusive
Exclusive workmanships
Fabrications exclusives

Eccelsa: le placchette colorate sono smaltate con lavorazione "guilloché";
è possibile arricchire Eccelsa con pietre dure preziose.

Eccelsa: the "guilloché" process is used to enamel the colored plates;
precious stones can also be used to embellish the Eccelsa range.

Eccelsa: les pastilles colorées sont guillochées et émaillées au feu;
Il est possible d'enrichir la série Eccelsa avec des pierres précieuses.



Doccette in finissima porcellana per Roma, Italica ed Eccelsa.

Italica, Roma and Eccelsa shower heads are made out of super-fine porcelain.

Les pommeaux de douche Italica, Roma et Eccelsa sont composés de porcelaine fine

Guilloché è una decorazione manuale che rende la superficie metallica “viva”. La luce fa percepire una vibrazione variando il punto di vista

Guilloché is a manual decoration which makes the metallic surface live. The light reflects differently on the metal according to the adopted point of view.

Le « **Guillochage** » est une décoration manuelle qui rend la surface métallique vivante. La lumière s’y reflète différemment suivant le point de vue adopté.

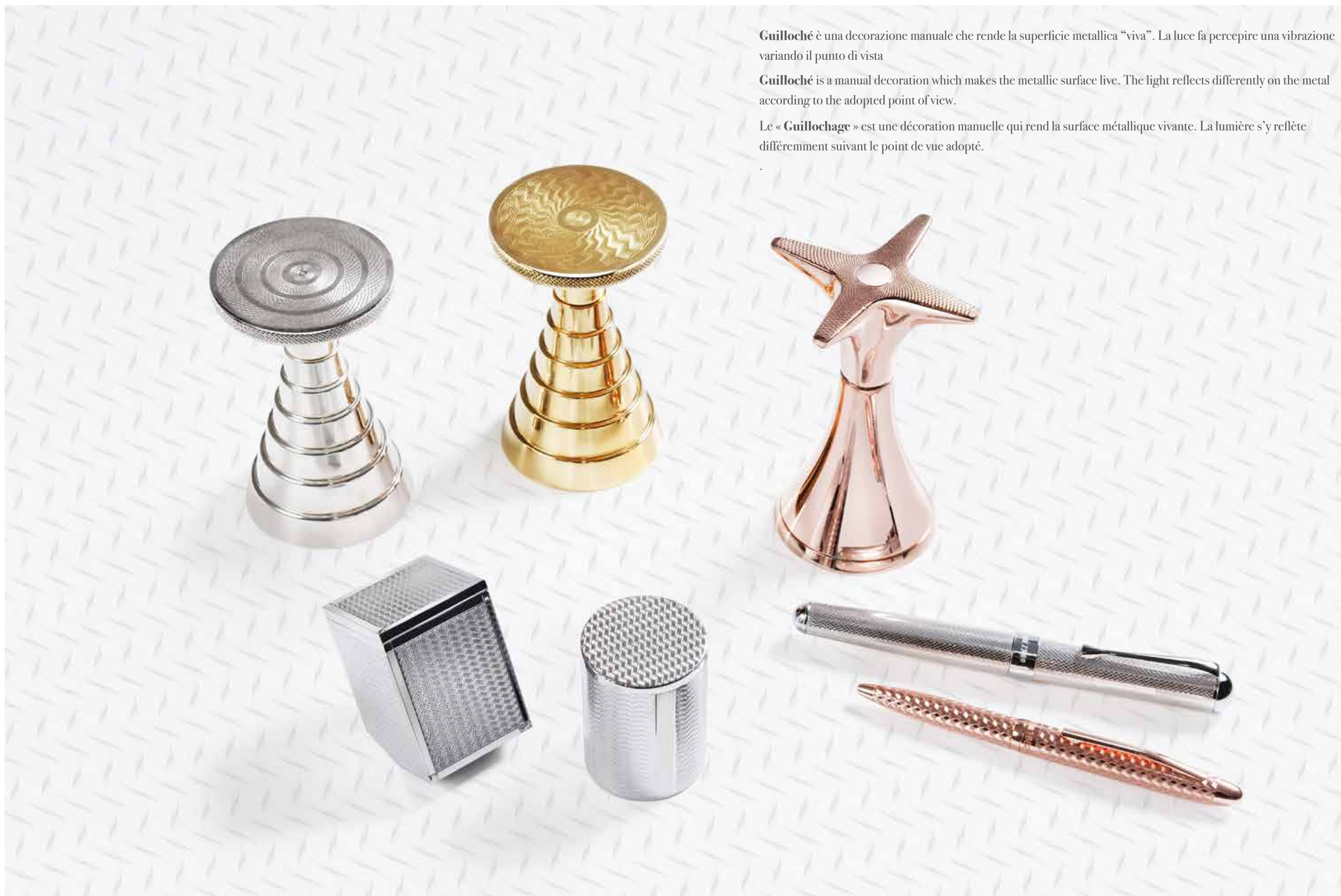

Finiture
Finishing
Finitions





Nichel Spazzolato
Nikel Matte
Nikel Mat



Oro Rosa
Rose Gold
Or Rose



Bronzo Scuro
Dark Bronze
Bronze Noir



Bronzo
Bronze
Bronze

FINITURE
FINISHING
FINITIONS

CR00 Cromo- Chrome

PV02 Nichel PVD - Nickel PVD

NI01 Nichel Spazz - Nickel Matte - Nickel Mat

PV01 Ottone PVD - Brass PVD - Laiton PVD

AU00 Oro - Gold - OR 24 Carats

AU02 Oro Rosa - Rose Gold - Or Rose

AG00 Argento - Silver - Argent

BZ00 Bronzo - Bronze

BZ01 Bronzo Scuro - Dark Bronze - Bronze Noir

FINITURE
FINISHING
FINITIONS



PV01



PV02



CR00



AU00



NI01



AG00



AU02



BZ00



BZ01

- CR00 Cromo - Chrome
- PV02 Nichel PVD - Nickel PVD
- NI01 Nichel Spazz - Nickel Matte - Nickel Mat
- PV01 Ottone PVD - Brass PVD - Laiton PVD
- AU00 Oro - Gold - OR 24 Carats
- AU02 Oro Rosa - Rose Gold - Or Rose
- AG00 Argento - Silver - Argent
- BZ00 Bronzo - Bronze
- BZ01 Bronzo Scuro - Dark Bronze - Bronze Noir



BZ01



AC00



PV01



AU00



CR00



BZ00



PV02



NI01



AU02

FINITURE
FINISHING
FINITIONS

CR00 Cromo- Chrome

PV02 Nichel PVD- Nickel PVD

NI01 Nichel Spazz - Nickel Matte - Nickel Mat

PV01 Ottone PVD - Brass PVD - Laiton PVD

AU00 Oro - Gold - OR 24 Carats

AU02 Oro Rosa - Rose Gold - Or Rose

AC00 Argento - Silver - Argent

BZ00 Bronzo - Bronze

BZ01 Bronzo Scuro - Dark Bronze - Bronze Noir



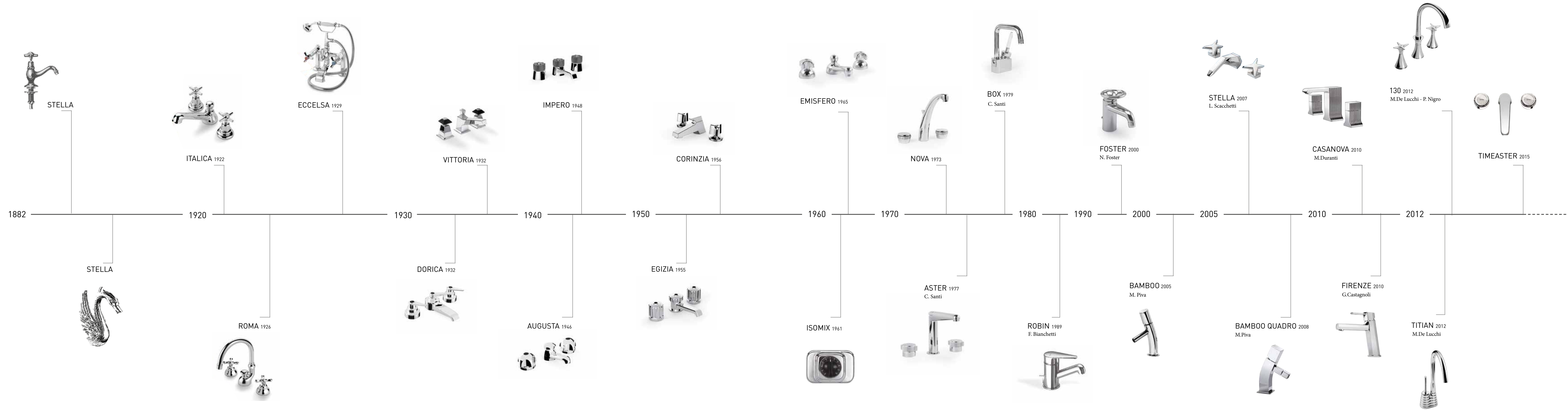

Italica

Collezione storica

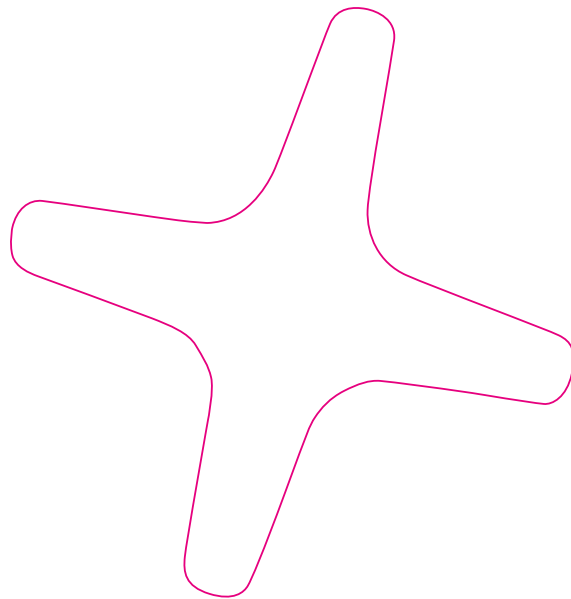

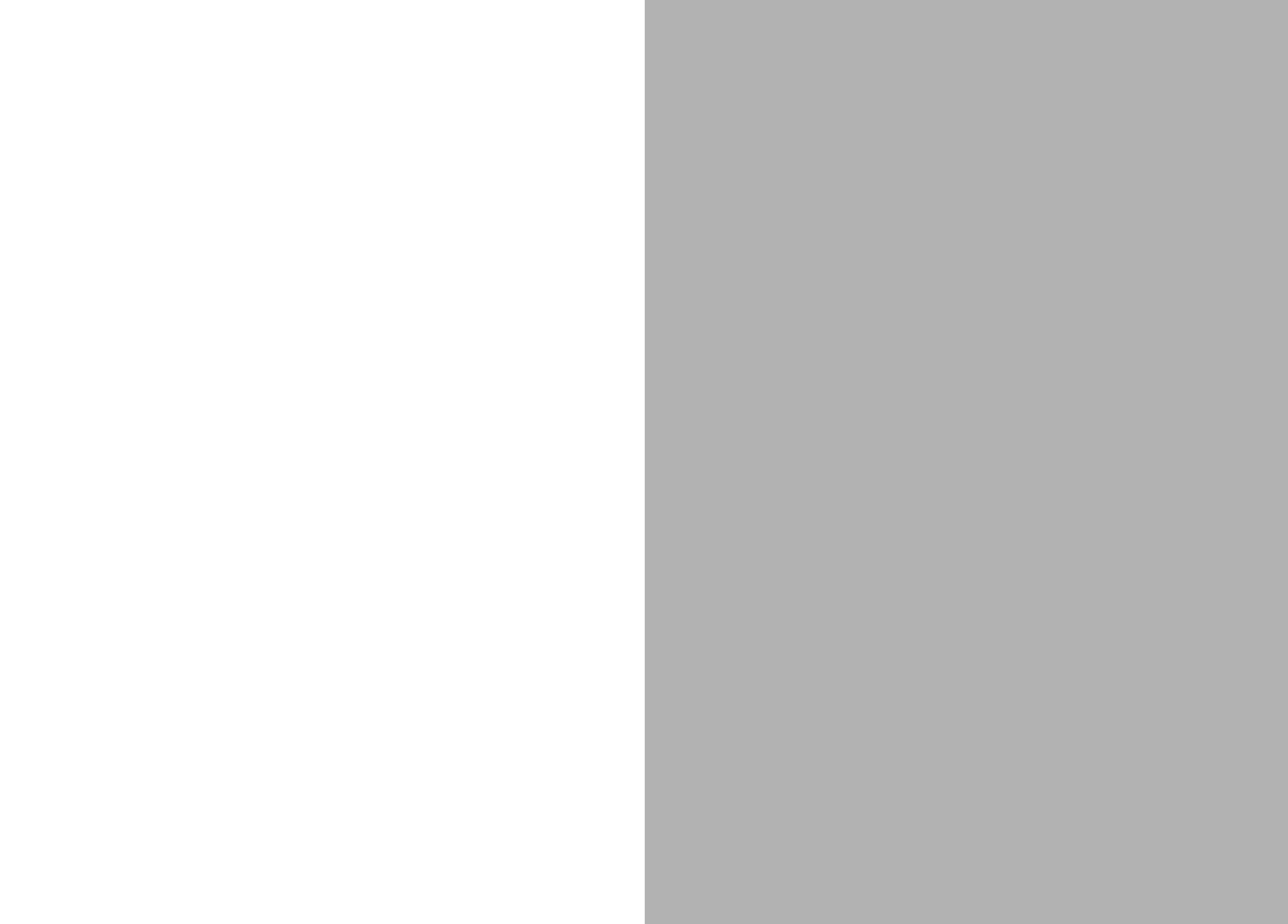

Italica









Isomix





Roma
Collezione storica

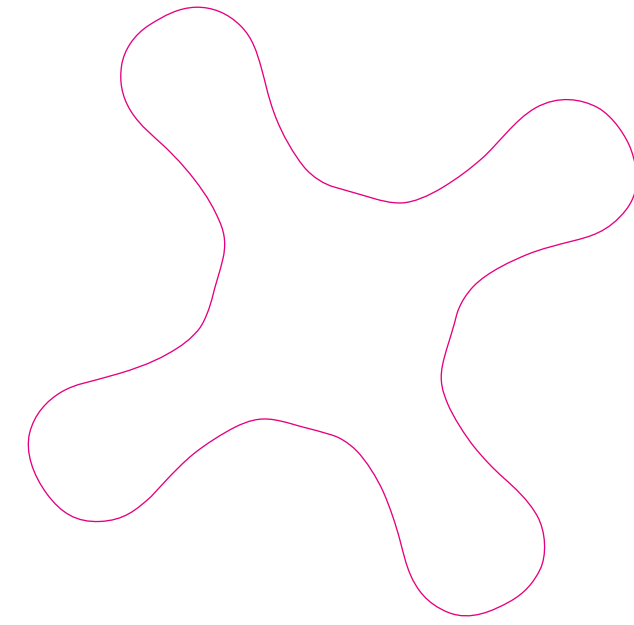

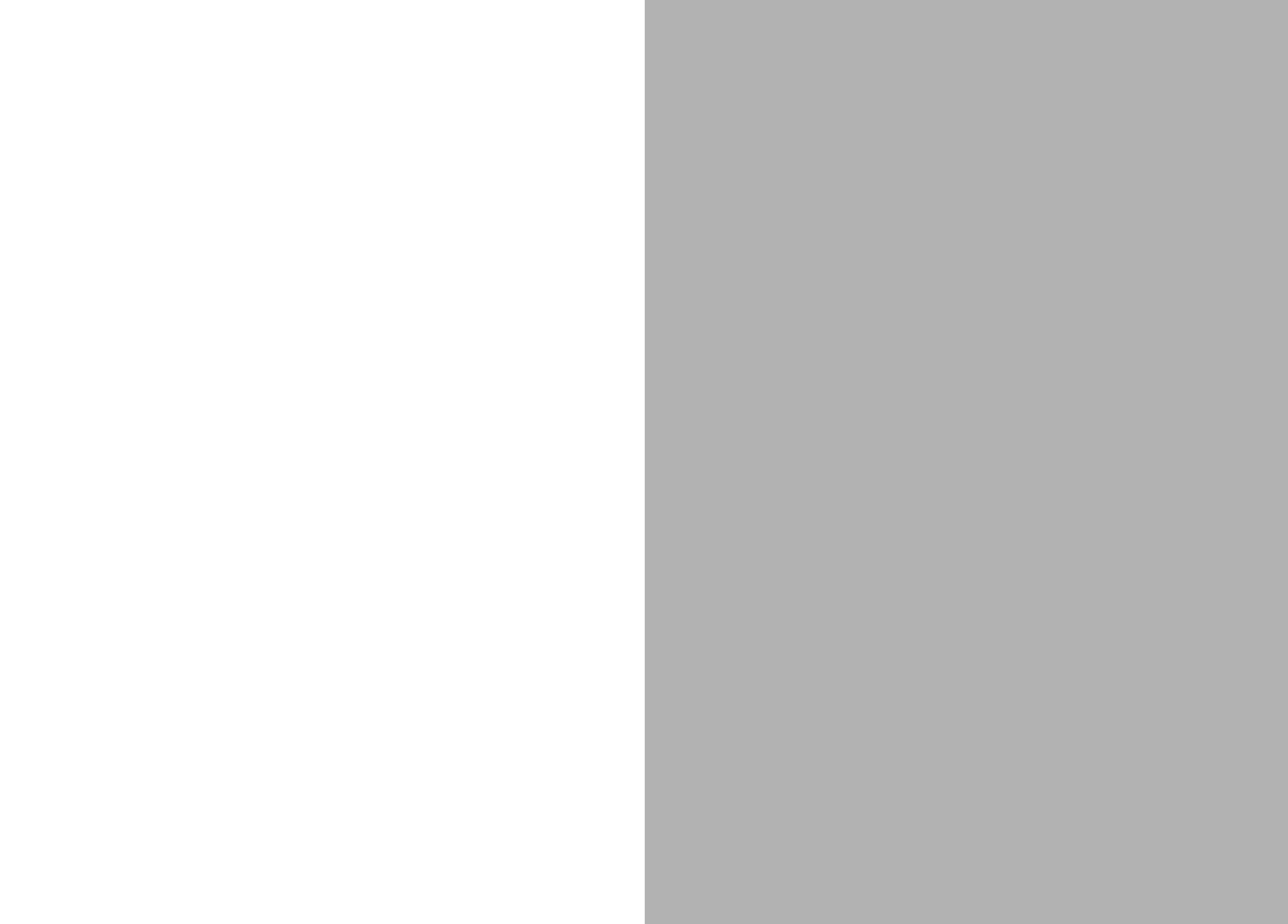



Roma











Eccelsa
Collezione storica

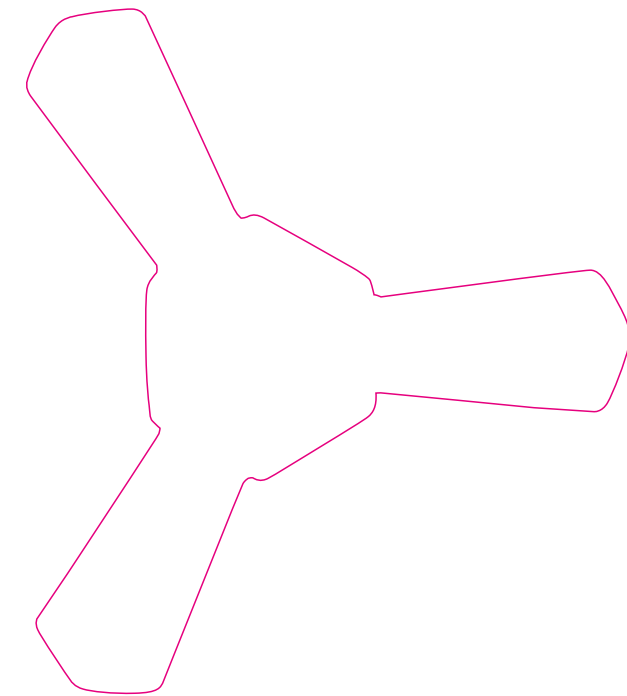

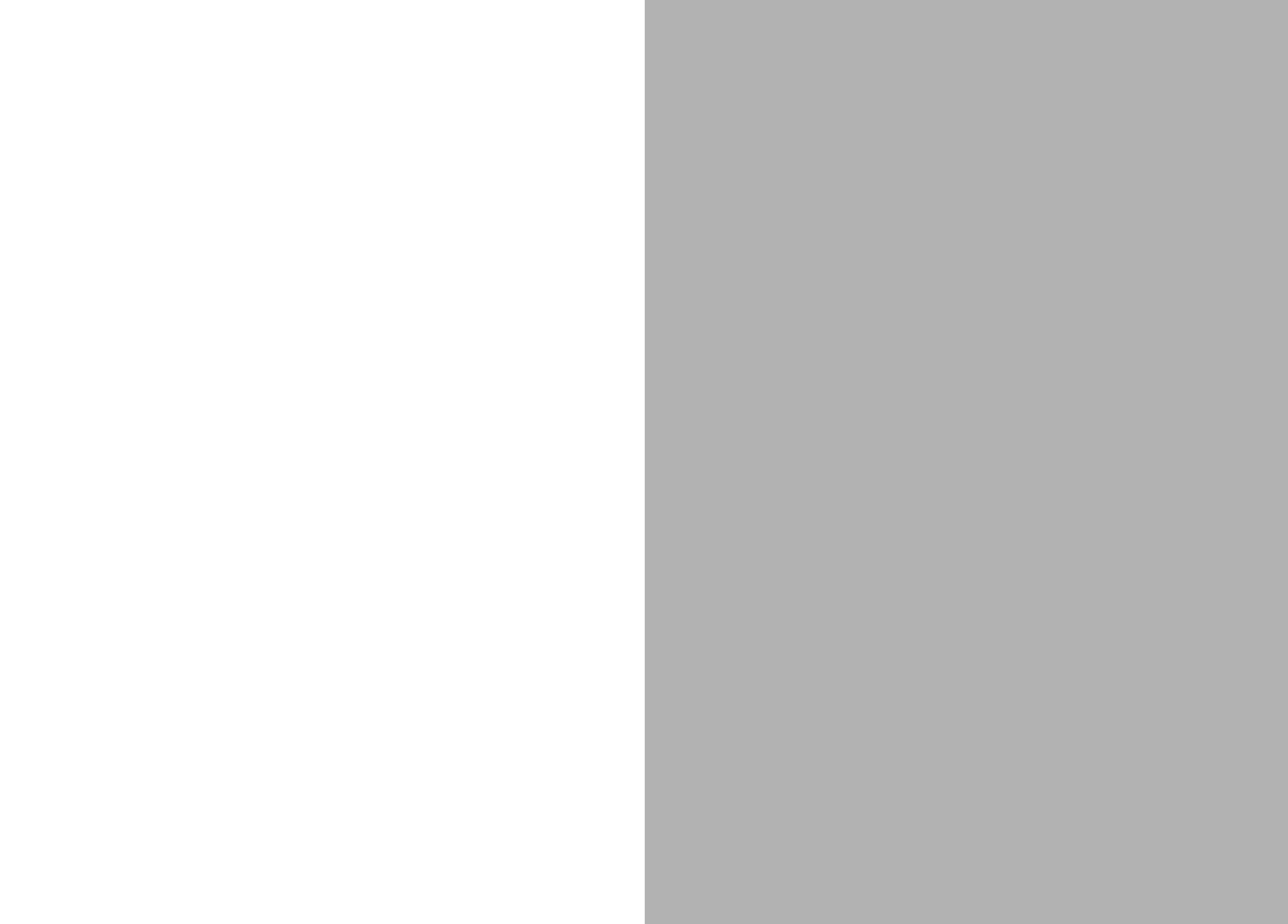

Eccelsa







Isomix







TITIAN
Design Michele De Lucchi

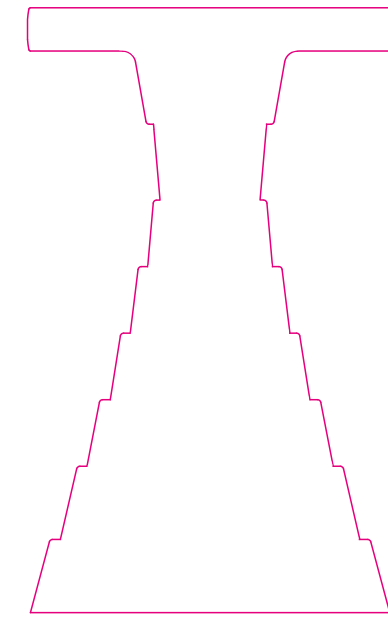



TITIAN





TITIAN





130

Design Michele De Lucchi - Philippe Nigro

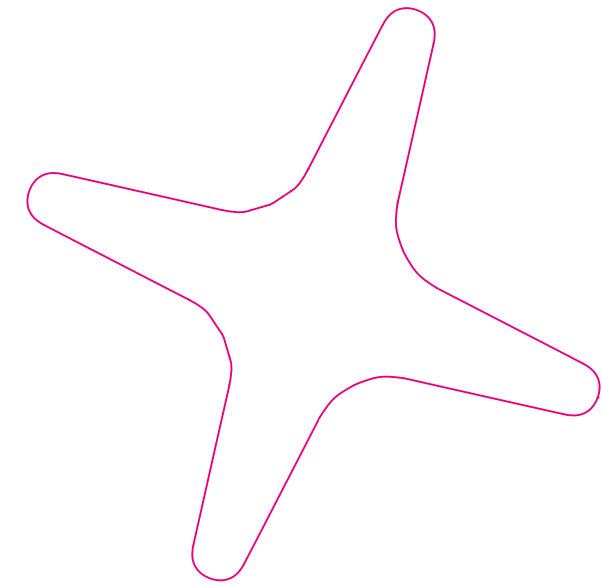



130





130





130



130



CASANOVA
Design Maurizio Duranti

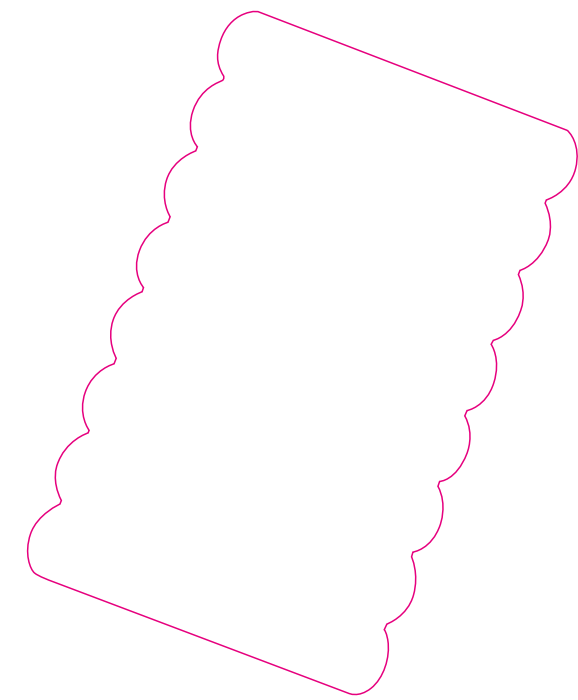

CASANOVA





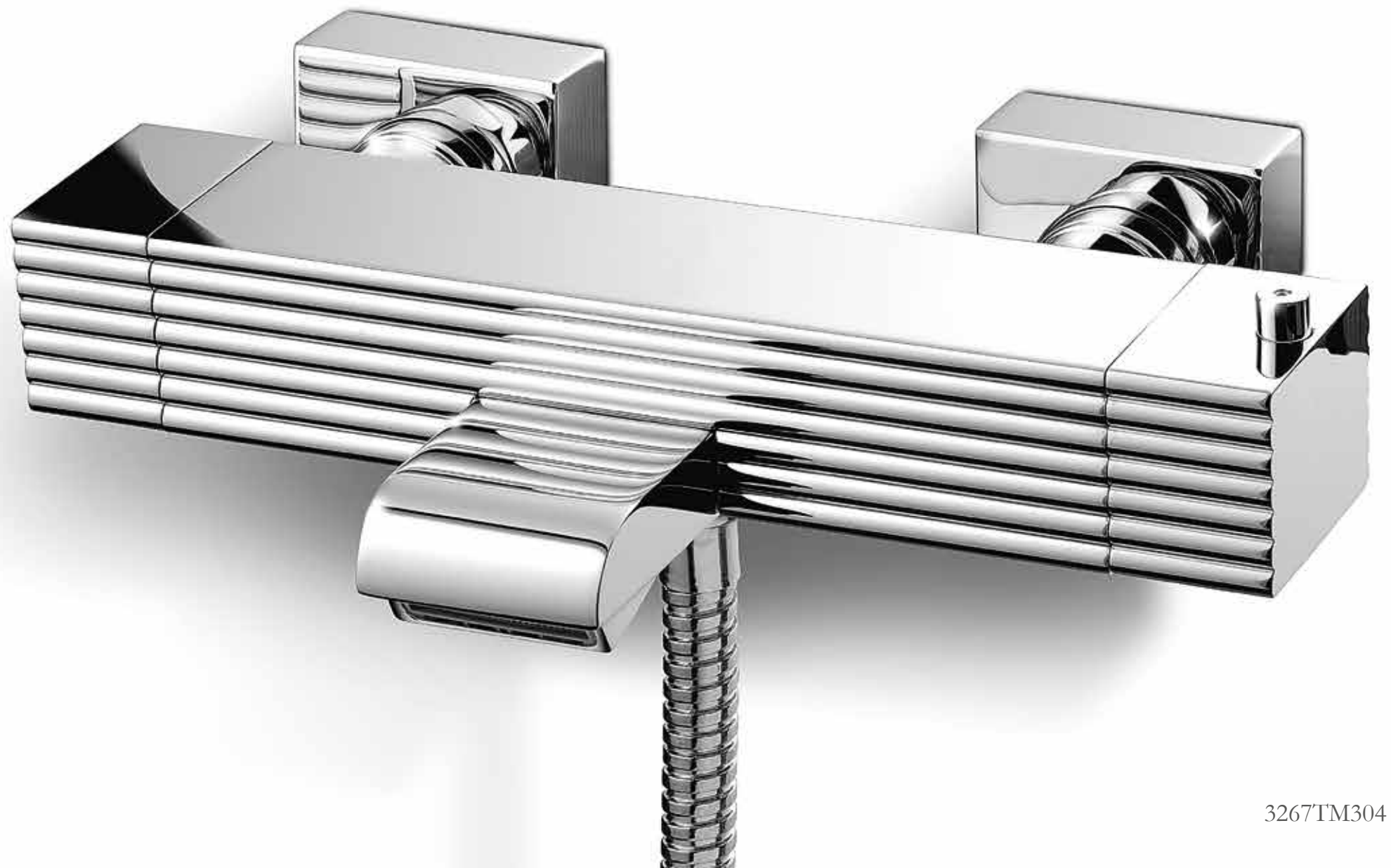

CASANOVA





CASANOVA



STELLA
Design Luca Scacchetti

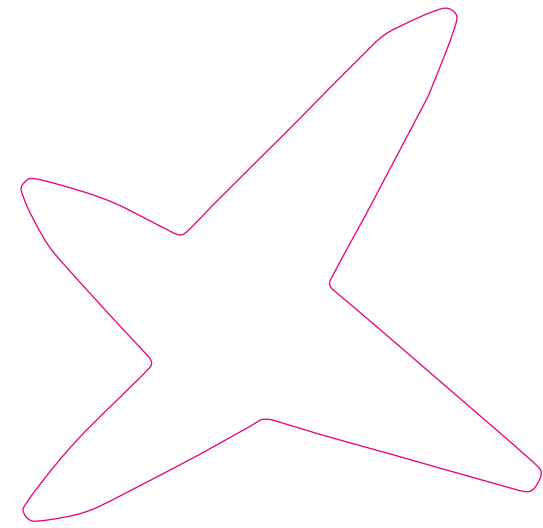

STELLA





STELLA





TIMEASTER

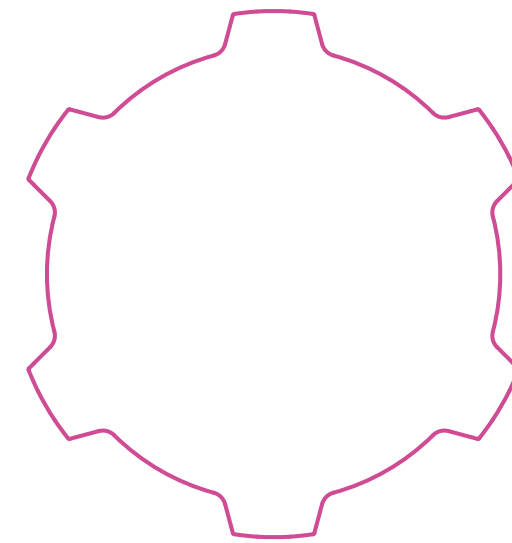

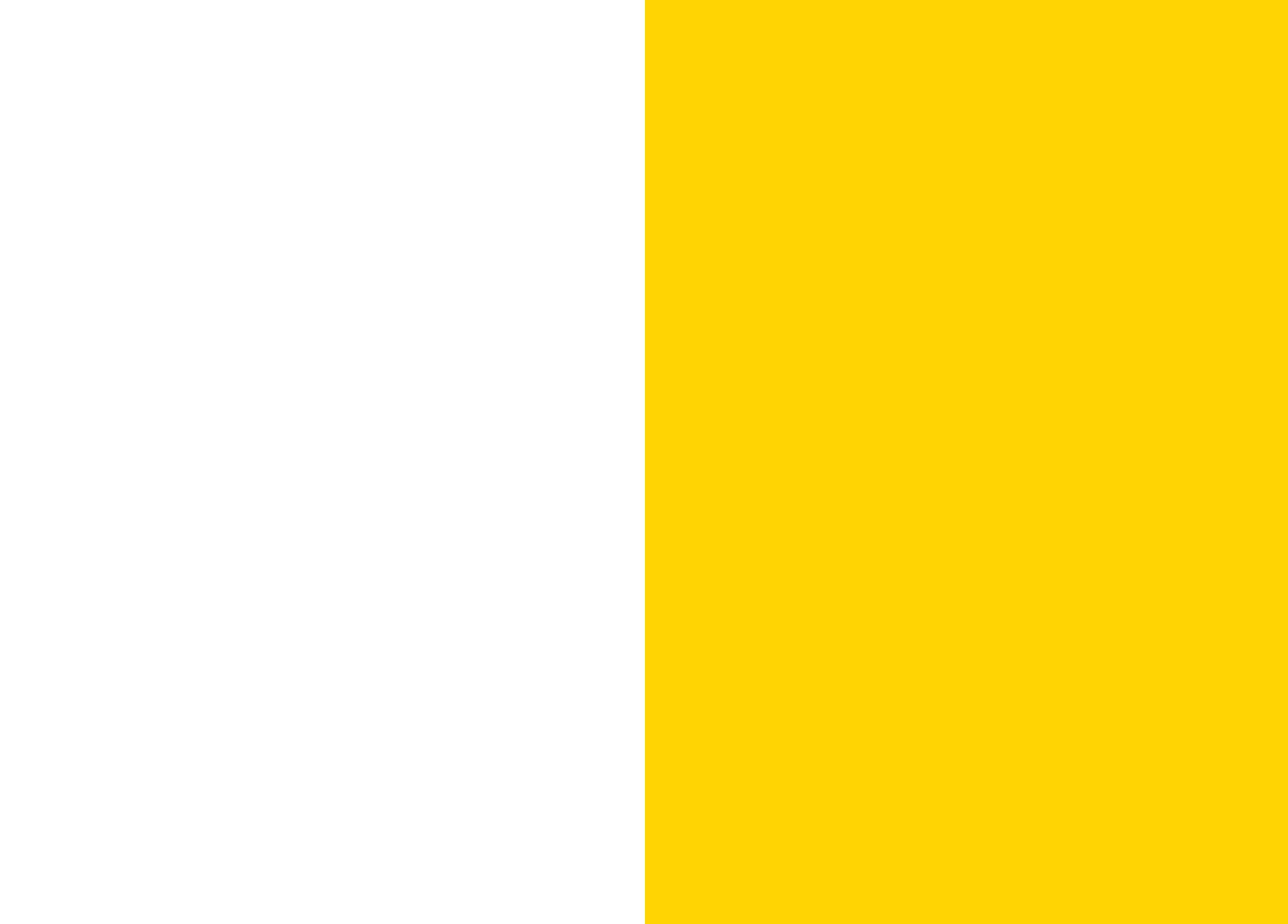

TIMEASTER





TIMEASTER





FIRENZE
Design Giampiero Castagnoli

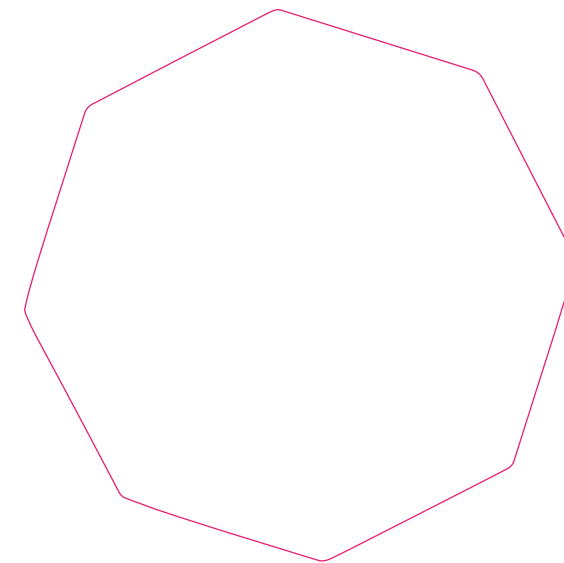



FIRENZE







3267TM304

Isomix



BAMBOO

Design Marco Piva

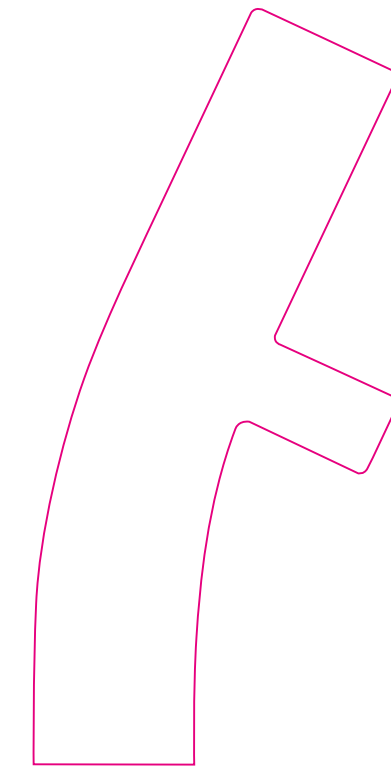



BAMBOO









SWAN

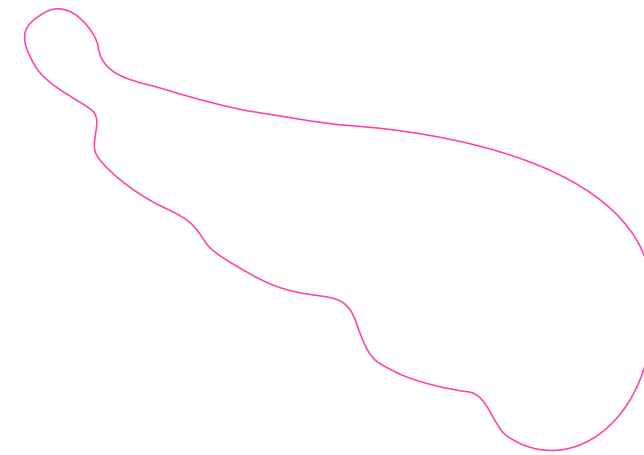







SWAN



Stella nel Mondo

Per i raffinati frequentatori dell'alta Hotellerie il bagno deve essere la massima espressione della bellezza, del lusso e dell'intimità.

Stella in the World

For the sophisticated guests of the world's top hotels, the bathroom needs to be the purest expression of beauty, luxury and intimacy.

Stella dans le Monde

Pour la clientèle raffinée des grands hôtels, la salle de bain doit être synonyme de beauté, de luxe et d'intimité.

Cavalieri Hilton - Roma
Excelsior Gallia - Milano
Grand Hotel et de Milan - Milano
Carlton Senato - Milano
Jolly Hotel President - Milano
Grand Hotel Villa d'Este - Cernobbio (CO)
Splendido - Portofino (GE)
Imperiale Palace - Santa Margherita Ligure (GE)
Hotel Excelsior Palace- Lido di Venezia
Danieli - Venezia
Palazzo Victoria - Verona
Hotel Cavalieri Hilton- Roma
Hotel Hassler Villa Medici--Roma
Villa La Massa - Firenze
JK Place - Firenze
Il Salviatino - Fiesole (FI)
Luna - Amalfi (SA)
Il San Pietro - Positano (SA)
Bellevue Syrene - Sorrento (NA)

Ritz - Parigi
Costes - Parigi
Raphael - Parigi
Millenium Opera, Parigi
Vernet, Parigi
D'aubusson, Parigi
Edouard VII, Paris
De Sers, Paris
Square, Paris
Pont Royal, Paris
Saint James Et Albany, Paris
Royal Palace, Evian
Ermitage, Evian
Westminter, Le Touquet
Le Royal Hôtel, Oran
Grand Hôtel De Cala Rossa, Porto Vecchio
Royal Riviera, St Jean Cap Ferrat
Beach Plaza, Principato di Monaco
Eden Rock, St Barthelemy
Louis Hotel - Monaco
Royal Windsor, Bruxelles
Park Hyatt, Jeddah
Heritage, Lisbona
The Raj Palace, India
Eden Rock, Saint Barthelemy
Mombasa Serena Beach, Kenya
Kampala Serena, Uganda
Soundouss - Rabat
Hyatt Equestrian Club II - Jeddah

Project
Carlo Suardi

Interview
Valentino Ronchi

Photo, post production
Gabriele Buratto
Stefania Zeccoli
stecia . NO
Mauro Porta. NO

Photographic archives
Edo Bertona . NO
WideStudio .NO

Print
Intese Grafiche .BS

Rubinerie Stella S.p.A.
Via Monte Bianco , Dormelletto (NO)
Tel. +39.0321.473351 - Fax: +39.0321.474231
www.rubineriestella.it
info@rubineriestella.it

