

## **TOWEL WARMERS**

Discover the Electric system

## **BATHROOM NEWS**

News from Stella world

## **ACCESSORIES**

Best completions for Bathroom

# SCALDASAVIETTE ELETTRICO

ELECTRIC TOWEL WARMERS | SÈCHE SERVIETTES ÉLETRIQUE

981E-983E

- Caratteristiche estetiche analoghe allo scaldasaviette ad acqua
  - Modello a 3 (981E) o 4 (983E) tubi, funzionamento a 230V
  - Interamente in ottone, realizzabile in tutte le finiture di listino
  - Tecnologia riscaldamento con cavo riscaldante Made in Italy
  - Non utilizzo di resistenze o liquidi termoriscaldanti (glicole)
  - Sensore di sicurezza per blocco temperatura
  - Interasse orizzontale 55 cm
  - Possibilità di fuori misura
- 
- Aesthetic features similar to the classic towel warmers
  - Available with 3 (981E) or 4 (983E) hoses, working at 230V
  - Fully in brass, available in all the finishes on the price list
  - Heating technology with heating cable Made in Italy
  - No resistors or heating liquids (glycol)
  - Safety sensor for temperature lock
  - 55cm horizontal interaxle spacing
  - Can be made to measure
- 
- Caractéristiques esthétiques similaires aux sèche-serviettes classiques
  - Modèles 3 tubes (981E) et 4 tubes (983E) disponibles, fonctionnant à 230V
  - Entièrement en laiton, réalisable dans toutes les finitions
  - Technologie de chauffage par câble "Made in Italy"
  - Aucune utilisation de résistances ou de liquides thermo-chauffant (glycol)
  - Capteur de sécurité pour le bloc de température
  - Entraxe horizontale de 55 cm
  - Faisable sur mesure



981E



## SCALDASAVIETTE - TOWEL WARMERS - SÈCHE SERVIETTES

981A-981AR-983A-983AR

FIG 1



PATENT PENDING

FIG 2

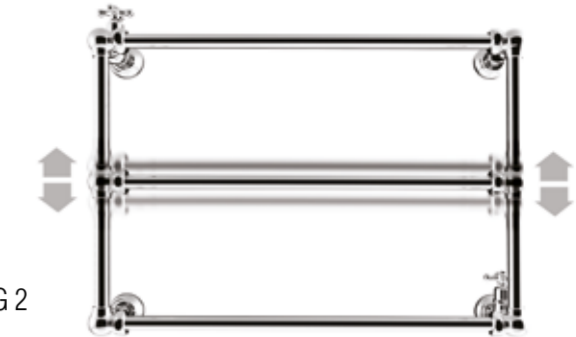

FIG 3



- Sistema telescopico (fig 1) per regolazione su interasse verticale fino a 2 cm (fig 2)
- Installazione semplificata sia su nuovo impianto sia in caso di ristrutturazione
- Regolazione dimensionale sull'interasse orizzontale al momento dell'installazione (fig 3)
- Realizzabile in tutte le finiture
- Installazione (fig 4) regolata dai 2 raccordi per entrata e uscita acqua (particolare A) e da 2 flange da muro passive (particolare B)

- Telescopic system (fig 1) allowing to adjust the vertical centreline up to 2 cm (fig 2)
- Simplified installation in both case: new implementation and/or renovation
- Dimensional adjustment on the horizontal axis during installation phase (fig 3)
- All finishes available
- Installation (fig 4) adjusted by 2 water fittings, inlet and outlet (detail A), and 2 passive wall flanges (Part B)

- Système télescopique (fig 1) permettant le réglage de l'entraxe verticale jusqu'à 2 cm (fig 2)
- Installation simplifiée à la fois lors de nouvelles installations mais aussi en cas de rénovation ou restructuration.
- Réglage dimensionnelle sur l'entraxe horizontale au moment de l'installation (fig 3)
- Disponible dans toutes les finitions
- Installation (fig 4) réglée par les 2 raccords pour l'entrée et sortie d'eau (détail A) et par 2 platines de fixation (détail B)

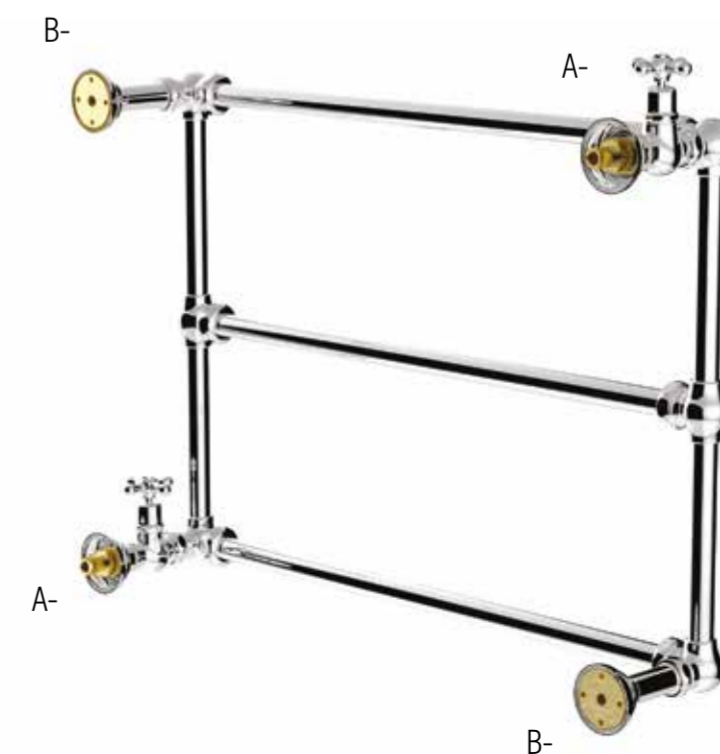

FIG 4

## 437 - 438

BOCCHIE A PAVIMENTO | FREE STANDING SPOUT | BEC AU SOL



Minimal e funzionale: le bocche da pavimento free standing sono la soluzione ottimale per le nuove scenografie di interior design dell'ambiente bagno.

Minimal and functional: free standing spouts are the optimal solution for the new interior design of the bathroom environment.

Minimaliste et fonctionnels, les bec au sol sont la solution idéale pour les nouvelles créations en terme de design d'intérieur de la salle de bain.





- Corpo incasso universale, con regolazione "messa in bolla" (schema A)
- Bocca a pavimento con rubinetto di apertura e chiusura (mod 437)
- Bocca a pavimento con rubinetto di apertura e chiusura e rubinetto di miscelazione (mod 438)
- Universal concealed body, with levelling regulation (scheme A)
- Free standing spout with water opening/closing ring (mod 437)
- Free standing spout with water opening/closing faucet and mixing faucet (Mod 438)
- Corps encastré universel, avec régulation "niveau à bulle" (schéma A)
- Bec de sol avec robinet d'ouverture et de fermeture (mod 437)
- Bec de sol avec robinet d'ouverture et de fermeture et robinet « mélangeur » (mod 438)

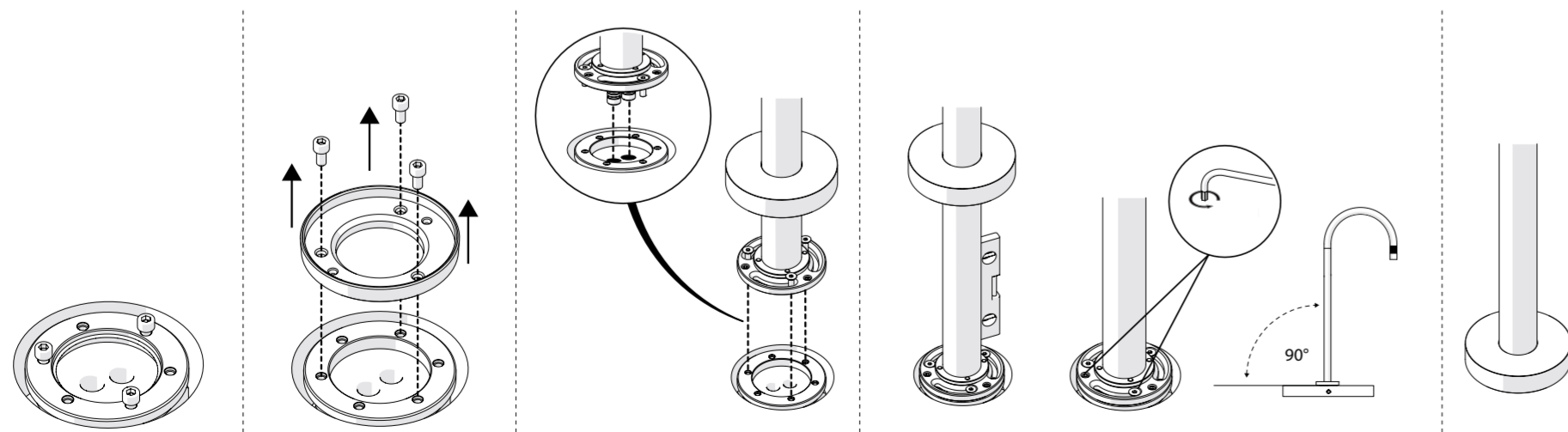

(schema A)

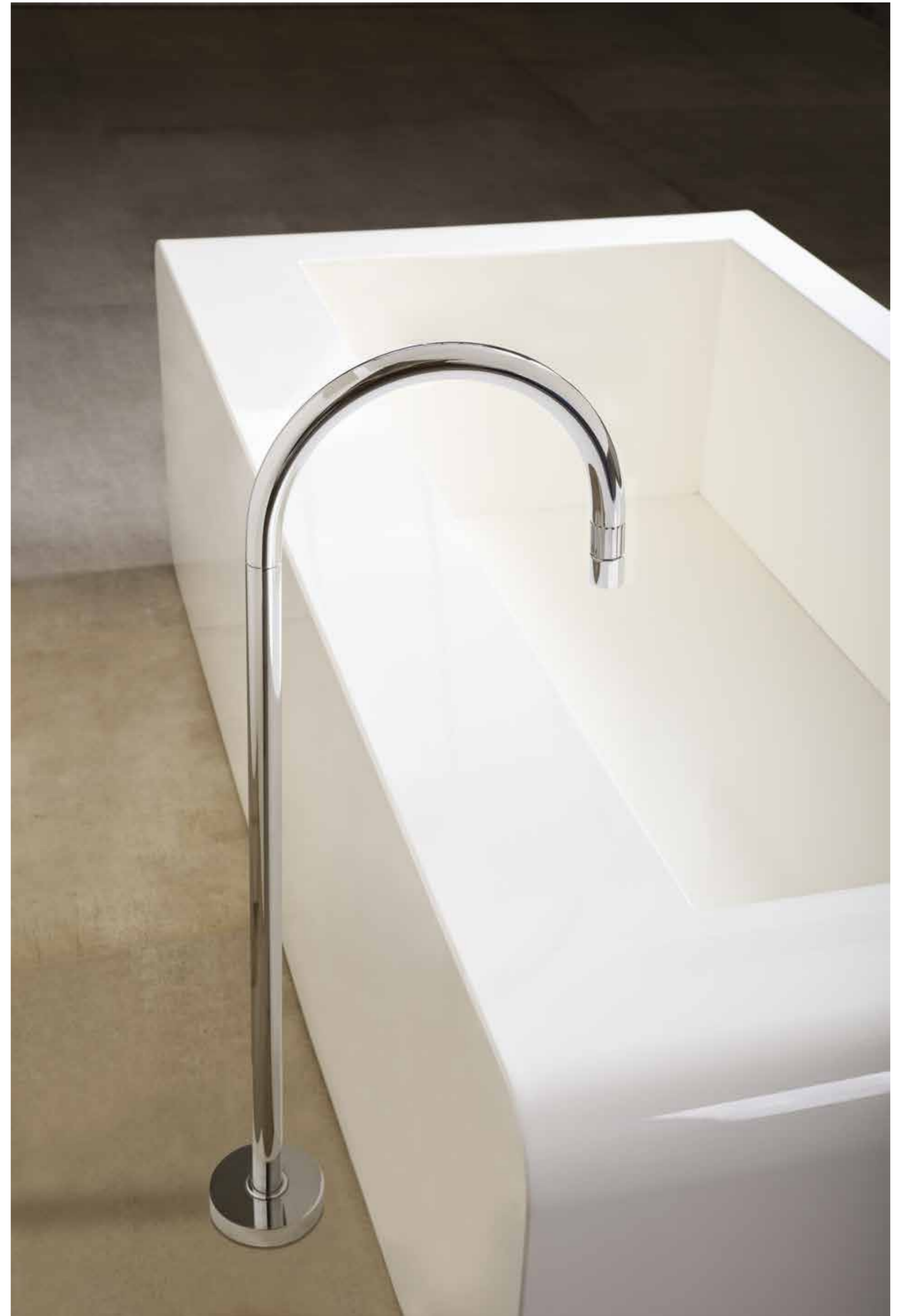



## ITALICA LEVE - ECCELSA LEVE

ITALICA - ECCELSA LEVER | ITALICA - ECCELSA MANETTE



La versione a leve per la serie Italice e Eccelsa, costituisce qualcosa di più che una semplice variante. Infatti le nuove maniglie e il vitone a dischi ceramici con apertura-chiusura a 90°, attribuiscono a tutta la serie un nuovo design esaltandone la modernità di queste collezioni degli anni 20..

The lever version for the Italice and Eccelsa collections is something more than a simple variant. In fact, the new handles and the ceramic headworks with 90° opening-closing feature give to the items a new design highlighting the modernity of these 20's collections.

La version à leviers pour les séries Italice et Eccelsa, représente plus qu'une simple variante. En effet, les nouvelles poignées à têtes céramiques avec une ouverture-fermeture de 90°, confèrent à la série un nouveau design exaltant la modernité de ces collections des années 20.





La serie Stella viene completata con l'introduzione del gruppo monoforo da lavabo (3219) e bidet (3604) entrambi con comando di scarico e dal gruppo vasca doccia esterno (3267/304) con deviatore a ritorno automatico.

Stella collection is completed with the introduction of the single-hole washbasin unit (3219) and bidet (3604) both with waste control and the external shower tub group (3267/304) with automatic return diverter.



La présentation des groupes monotrou de lavabo (3219)



et de bidet (3604), tous deux avec vidage, et celui pour baignoire externe (3267/304), avec inverseur à retour automatique, viennent compléter la série Stella.

**stella**  
1882

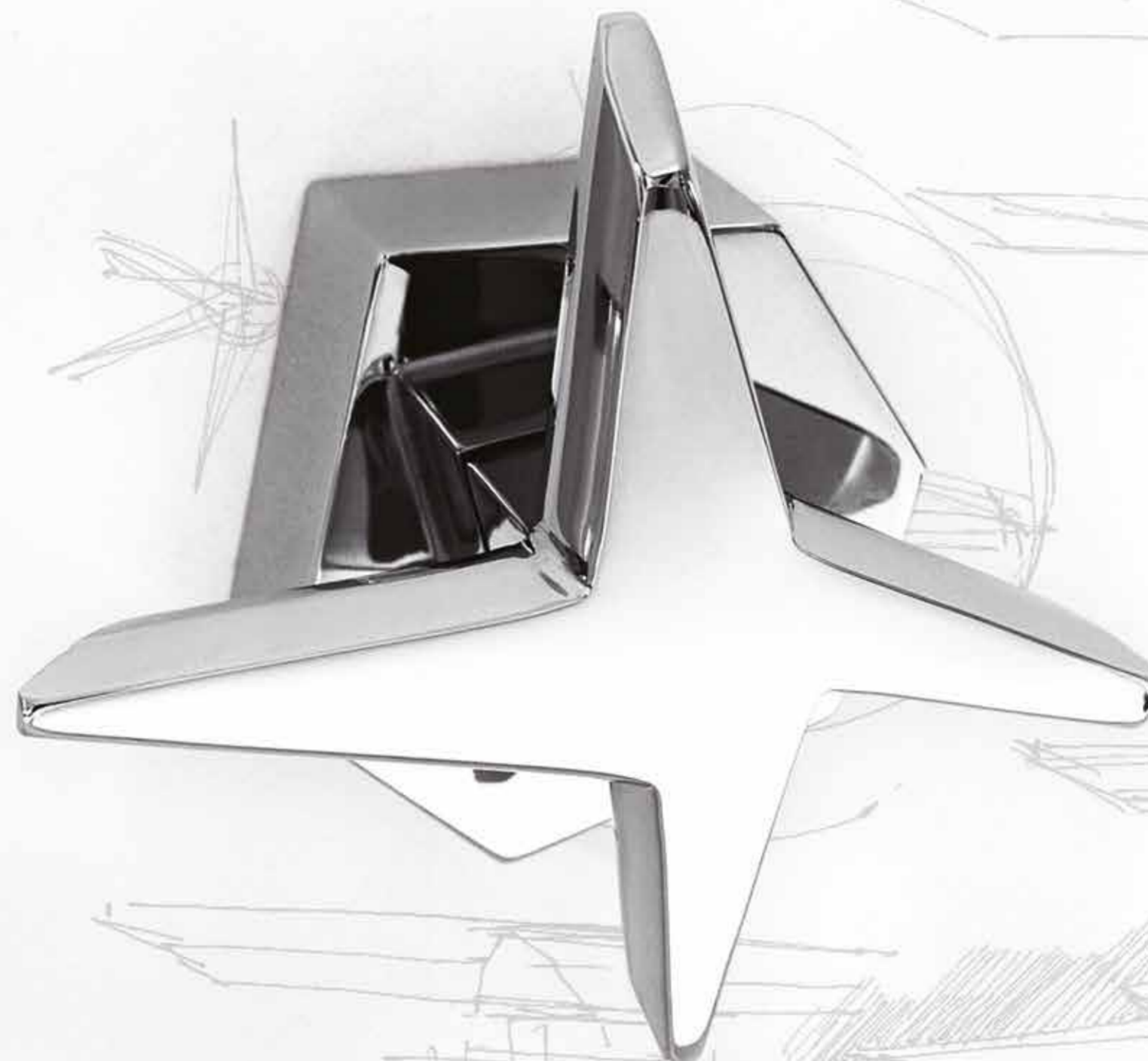

## LUCA SCACCHETTI

Luca Scacchetti è stato un architetto e designer, con campi di lavoro che hanno spaziato dal design, all'architettura, design interni e urbanistica. Ha collaborato nel corso della sua carriera con le aziende leader in Italia e nel mondo nella produzione di mobili, illuminazione, mobili d'ufficio e da bagno.

Luca Scacchetti was an architect and designer, working on various fields such as Design, Architecture, Interior Design, and Urban Design. During his career, he cooperated with the greatest leading companies, from across Italy and the World, specialized in the bathroom, lighting office and furnitures production.

Luca Scacchetti était un architecte et designer, avec des travaux variés allant du Design, à l'Architecture, en passant par le Design d'intérieur et l'Urbanisme. Il a travaillé tout au long de sa carrière avec les principales entreprises leader, en Italie mais aussi dans le Monde, sur le Marché de la production de meubles, de luminaires, d'équipement de bureau ou encore de salles de bain.

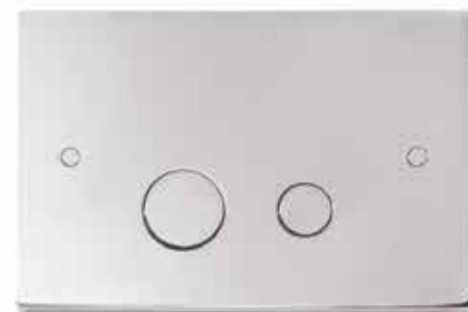

CROMO | CHROME

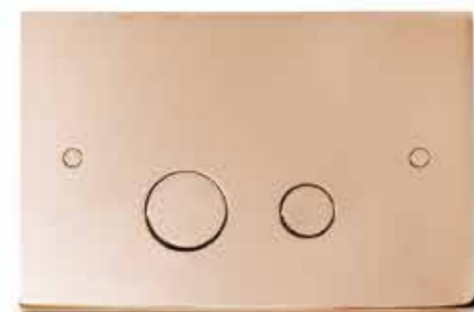

ORO ROSA | ROSE GOLD | OR ROSE

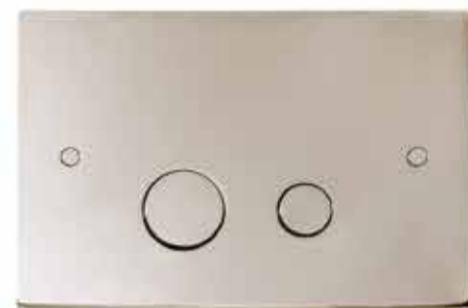

NICHEL | NICKEL

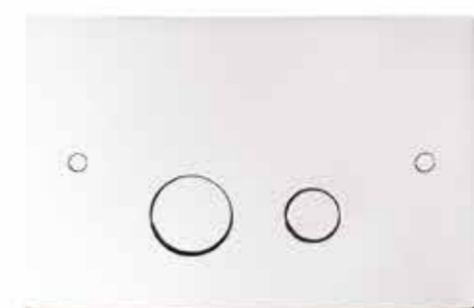

ARGENTO | SILVER | ARGENT

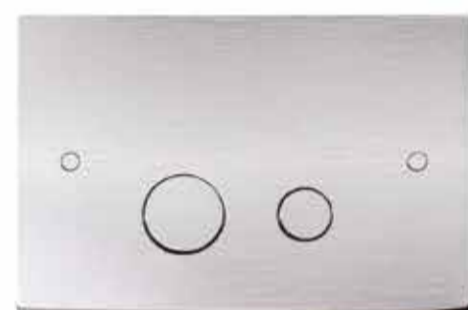

NICHEL SPAZZOLATO | NICKEL MATTE | NICKEL MAT



BRONZO SCURO | DARK BRONZE | BRONZE NOIR

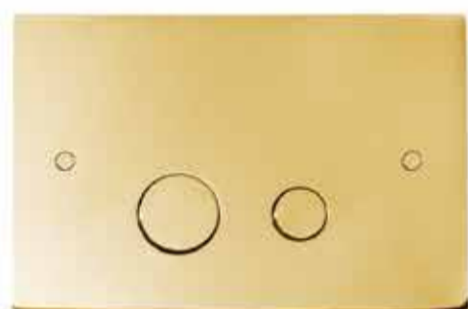

ORO | GOLD | OR 24 CARATS

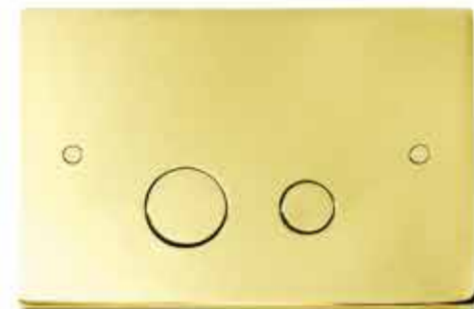

OTTONE PVD | BRASS PVD | LAITON PVD

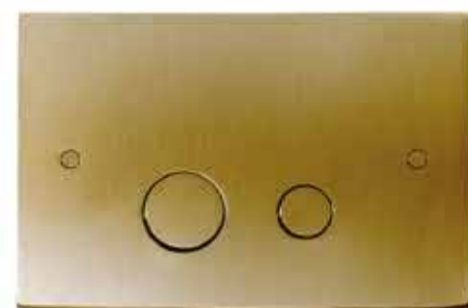

BRONZO | BRONZE

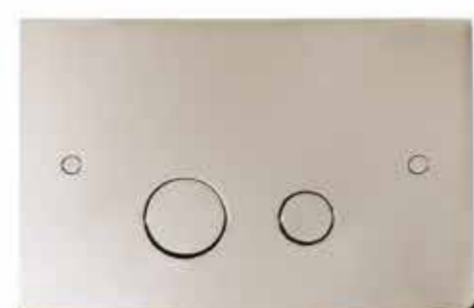

NICHEL PVD | NICKEL PVD

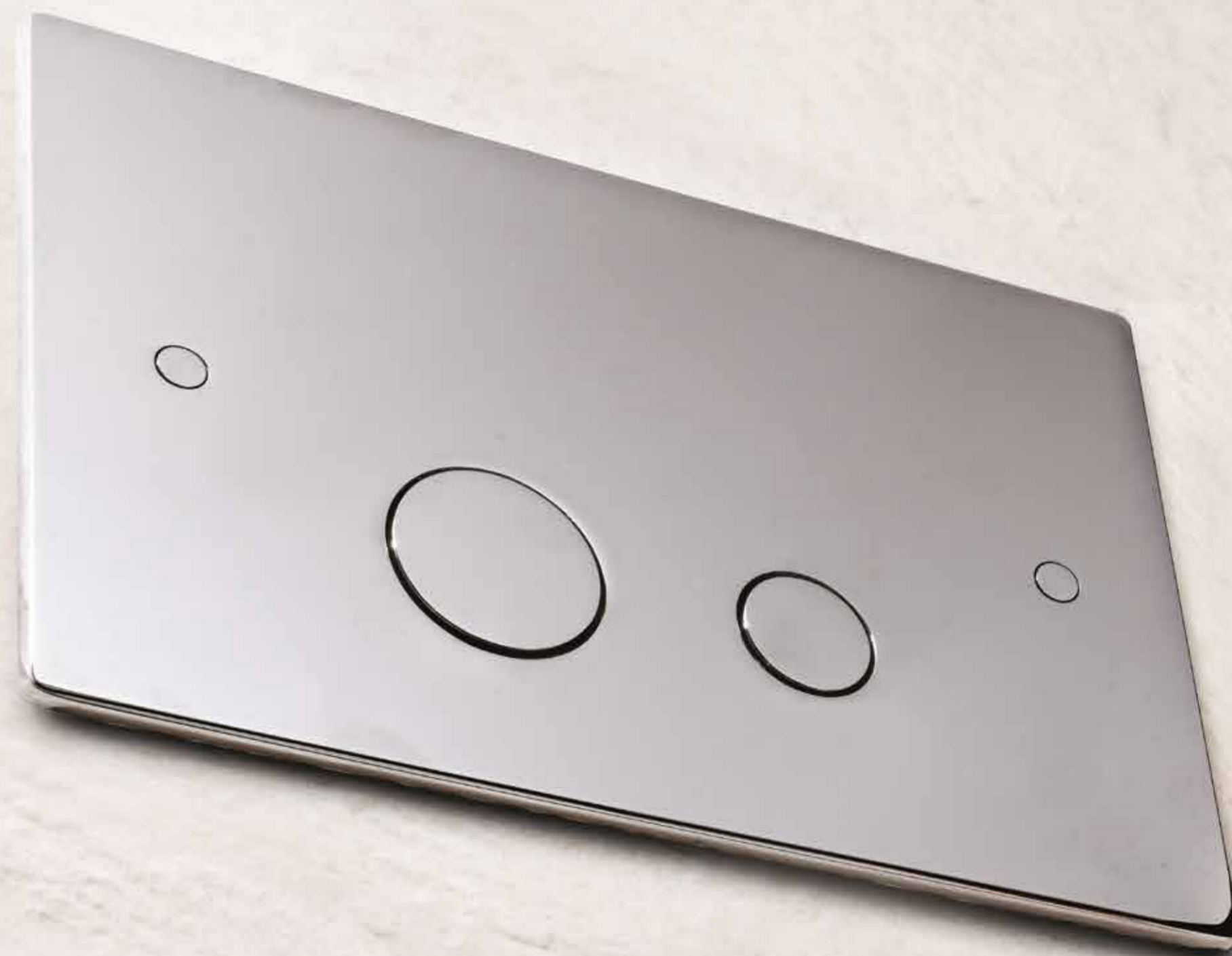

**3820**

PLACCA SCARICO  
FLUSHING PLATE  
PLAQUE DE DÉCLENCHEMENT WC

- Compatibile con le cassette Geberit UP320 et UP720
- Totalmente in Ottone, disponibili in tutte le finiture
- Doppio pulsante per risciacquo "eco" e "full"
- Compatible with Geberit Drainbox UP320 et UP720
- Totally made of Brass, available in all finishes
- Both "eco" and "full" rinsing button
- Compatible avec les systèmes encastrés Geberit UP320 et UP720
- Entièrement en laiton, disponible dans toutes les finitions
- Double chasse d'eau : « éco » et « totale »



Tra le molte figure introdotte, abbiamo selezionato quelle che rappresentano le massime espressioni della volontà di Stella di essere sempre pronta alle crescenti richieste del mercato e alle necessità dei progettisti e interior design che ricercano il prodotto con caratteristiche estetiche uniche.

- la bocca 0/256 per lavabo (fig 1), abbinabile a maniglie storiche e contemporanee
- il braccio doccia a "L" (fig 2); scomposto come tutti i bracci doccia dai soffioni per permettere una scelta di composizione ancora maggiore
- i bracci doccia da soffitto per serie in modo da poter facilitare le installazioni dei soffioni doccia, come l'articolo 299bis (fig 3)
- Il corsoio, in serie Roma e Italica, per la doccetta da applicare al tubo doccia dei gruppi doccia esterni mod 301 (fig 4)
- Il gruppo termostatico esterno per vasca/doccia della serie Italica (fig 5)



FIG 1



FIG 2



FIG 3

Among the many new features introduced, we have chosen those that represent the utmost expression of Stella's will to be always ready for the growing market request and for the needs of designers and interior designers who look for products with unique aesthetic features.

- 0/256 washbasin spout (fig 1), which can be combined with historical and contemporary handles
- "L" shaped shower arm (fig 2); Divided from the shower head, like all shower arms, to allow even more composition choices
- Ceiling mounted shower arms to facilitate the installation of shower heads, such as Article 299bis (fig 3)
- Sliders for the hand-shower, in Roma and Italica collection, to be applied to the external shower tubes such as model 301 (fig 4)
- The Italica series external thermostatic bath/shower mixer (fig 5)

FIG 4



Parmi les nombreuses nouveautés présentées, nous avons sélectionné celles qui illustrent le mieux la volonté pour Stella d'être toujours prêt à la demande croissante du Marché et aux besoins des architectes et designer d'intérieur qui recherchent le produit aux caractéristiques esthétiques uniques.

- Le bec 0/256 pour lavabo (fig 1), peut être combiné avec des poignées traditionnelles et contemporaines
- le bras de douche à "L" (fig 2); décomposé comme tous les bras de douche par les pommes pour permettre la plus grand choix de composition
- les bras de douche au plafond par série, afin de faciliter l'installation des pommes de douche, comme l'article 299bis (fig 3)
- le coulisseau pour douchette, dans la série Roma et Italica, intégré à la colonne de douche pour les groupes externes mod 301 (fig 4)
- Le groupe thermostatique externe pour baignoire / douche pour la série Italica (fig 5)



FIG 5

# BAMBOO QUADRO

ACCESSORI - ACCESSOIRES - ACCESSORIES



1082

1082BIS

1012/B016

1022/P026

602/40

1033

**1082** Porta-abiti | Hook | Porte-peignoir

**1082bis** Porta-abiti doppio | Double hook | Porte-peignoir double

**1012/B016** Portabicchiere a muro con bicchiere | Tumbler holder with tumbler | Porte-verre sur paroi avec verre

**1022/P026** Portavaschetta a muro con vaschetta | Soap dish holder with soap dish | Porte-savon sur paroi avec coupelle

**602/40** Asta portasalviette - lunghezza 400 mm | Towel rail - length 400 mm | Porte serviette de 400 mm

**1033** Portarotolo | Toilet roll holder | Porte-papier

**1052** Portascopino a parete | Wall mounted toilet brush set | Porte-balai sur paroi

1052

# GUILLOCHÉ

Guilloché è una decorazione manuale che rende la superficie metallica "viva". La luce fa percepire una vibrazione variando il punto di vista

"Guillochage" is a manual decoration which makes the metallic surface live. The light reflects differently on the metal according to the adopted point of view.

Le « Guillochage » est une décoration manuelle qui rend la surface métallique vivante. La lumière s'y reflète différemment suivant le point de vue adopté.





Nella flagship lounge Casa Alitalia Roma e Casa Alitalia Malpensa progettati dallo studio Marco Piva recentemente completati potrete trovare oltre agli ambienti eleganti, ospitali e confortevoli anche rubinetti elettronici Teletron, esempio tangibile dell'affidabilità e della qualità della produzione Stella.

In the recently built flagship lounges Casa Alitalia Roma and Casa Alitalia Malpensa, designed by Marco Piva studio, you will find, in addition to the elegant and comfortable environments, our electronic taps Teletron, a tangible example of the reliability and quality of Stella's production.

Dans les salons VIP "Casa Alitalia Roma" et "Casa Alitalia Malpensa" conçues par le studio Marco Piva et récemment terminées, vous trouverez en plus d'une atmosphère élégante, accueillante et confortable, nos robinets électroniques Teletron, exemple concret de la fiabilité et de la qualité de la production Stella.





Rubinerie Stella Vi aspetta a:

**CERSAIE** - BOLOGNA 25-29 Settembre **PAD 30** stand **D16-E15**

**ARCHITECT@WORK** - ROMA 11-12 Ottobre **STAND 34**

**ARCHITECT@WORK** - MILANO 29-30 Novembre **STAND 124**

**stella**  
1882

Rubinerie Stella S.p.A.  
Via Monte Bianco snc - 28040 Dormelletto (NO)  
Tel. +39.0321.473351 - Fax: +39.0321.474231  
[www.rubinetteriestella.it](http://www.rubinetteriestella.it) | [info@rubinetteriestella.it](mailto:info@rubinetteriestella.it)