



Free your landscape design



IMAGE'IN



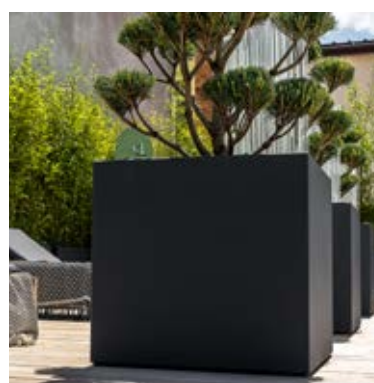

Table of contents

Image'In by Atelier So Green

Committed Designer & Manufacturer

The Fibre Cement

Made-to-measure Manufacture



The Virtual Range

Cubes

Rectangles

Pyramids

Specials

Finishes

Options

Water Management

Implementation

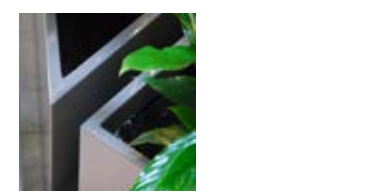



OUR AREAS OF EXPERTISE UNITED AT THE SERVICE OF OUTDOOR LAYOUTS

ATELIER SO GREEN studies, sizes and produces products in line with your specific needs.

An activity ocused on three brands : Image`In / Steelab / CJCJ.

Different offers that share a common philosophy and resources.



Ever since it was first set up back in 1984, the family-run limited liability company «Création Jean Claude Joly sarl» has been committed to studying and manufacturing urban fixtures to meet specific needs. The company has been developing technical lighting integration solutions since 1991 under the original brand **CJCJ**, thanks to its multi-skilled technical know-how encompassing fibre-cement processing, sheet metal work and the concrete and mirror trades among others.

In 2007, the company designed the **IMAGE`IN** range for gardens, patios, balconies, ...

Sleek, clean-lined fibre-cement planters for indoor or outdoor use. This has now become our main line of business today, expanding over the years particularly to include outdoor furniture to go with our plant tubs : benches, storage boxes, side tables, Salon lounge range ...

Last but not least, to cater to needs where fibre cement is no longer the best solution, we have come up with an additional sheet metal range : **STEELAB**. Together with our local partner, we jointly oversee the manufacture of sheet metal planters and furniture for urban fixtures, large-scale projects calling for high production capacities, or to address weight or volume restrictions ...

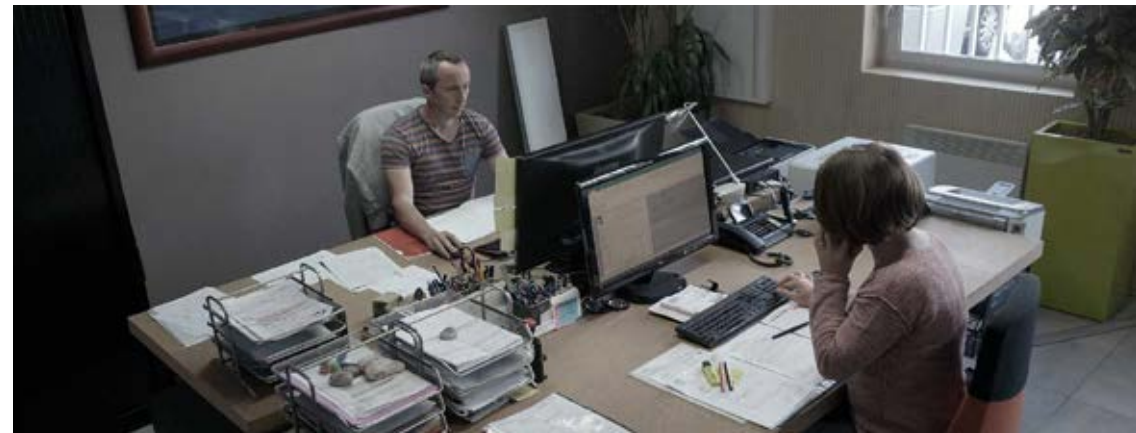

DESIGNER & MANUFACTURER COMMITTED TO ENVIRONMENTAL AND SOCIETAL QUALITY

MADE IN FRANCE

Our workshop is a craft business guaranteeing 100% French manufacture.

ATELIER SO GREEN is located in Touraine, in the heart of an industrial park for small businesses.

Between rivers, vineyards and forests, nature and human activity live together with harmony.

We attach great importance to our skilled, local workforce and the use of top-of-the-range tools, guarantees of our employees' safety and the quality of our products.

Our materials and accessories all come from Europe, mainly from France.

SUSTAINABLE COMMITMENT

Committed as we are to rational consumption and in order to ensure lasting quality, we have chosen to use such long-lasting materials as fibre cement, bicomponent PU paints and finishing varnishes.

We focus our efforts on providing aesthetic, long-lasting solutions that harmonise with their surroundings. Commitment is one of the company's founding values, and has been expressed from its very beginnings through attentiveness to our customers' needs and expectations, as well as through our product design and manufacture processes. It is commitment that inspires all the company's initiatives.



ENVIRONMENT

Commitment to optimised management of materials. Fibre cement is a mineral material used in green construction due to its inherent qualities. Our supplier is eco-responsible in its own right, with ISO14001 certification.

Our bicomponent polyurethane paints and our glues are manufactured in France. We use paints similar to those used in the automotive sector : LOW VOC ensuring compliance with the law on limitation of emissions of volatile organic compounds.

We produce no paint waste; all residual paint is used to weatherproof the insides of our planters.

With a view to reducing offcuts (<10%) we use software designed to optimise cutting. Offcuts are reused to manufacture sample cards and small presentation planters.

Workshop waste is sorted and recycled at a specialised treatment facility (rubble, paper and cardboard, and wood).



THE FIBRE-CEMENT

Planters & Furniture ImageIn are manufactured in fibre cement HDNT (High density new technology) in thickness of 10 or 15 mm depending on the product sizing. The panel is composed of a mixture of cement, natural fibers, mineral fillers, and additives. The plates thus obtained are doubly compressed and then autoclaved.

This material, standed out through high stability, is worked by cutting and gluing. Then it is laquered and varnished for an optimal coat.

Its composition

WATER : Essential component for the manufacture of fiber cement, it is used to transport raw materials during the process and it is also present in the finished product. Its use is limited to the minimum necessary. The factories operate in closed circuit and reuse their industrial wastewater.

CEMENT : Binder hydraulic mineral, based limestone and clay, which allows to agglomerate the sand, fibers, etc.. Cement from cement plants located near the places of manufacture.

CALCIUM CARBONATE : It is used as a filler in the product.

AMORPHOUS SILICA : Dust residual of the fumes in the silicon industry. Amorphous silica is a byproduct of the manufacture of silicon, ferrosilicon and some alloys. Since 1997, fiber cement values this product by using it in its manufacture.

POLYVINILALCOOL : Synthesis fiber of organic origin whose main components are coal and oil. This fiber traditionally used in the manufacture of textiles, gives the product its mechanical resistance. Suppliers are mostly in Japan and are engaged in type ISO 14001 approaches.

CELLULOSE : Organic fiber derived from wood and paper. Once refined cellulose fibers are used to trap and to agglomerate the cement to form a plate. Suppliers are involved in processes of responsible forest management : FSC / PEFC / ISO 14001.

Its Qualities

ENVIRONMENTAL RESPECT

Its composition makes it perfectly respectful throughout the manufacturing cycle / implementation / deconstruction.

FROST PROOF

Insensitive to cold or to the most intense heat.

MOISTURE RESISTANT

It is totally insensible to moisture.

LONG-LASTING

Its nature and quality ensure a long-term use.

THERMAL VALUE

Its conductivity is particularly low.

NON-COMBUSTIBLE

By nature it is incombustible and is classed : MO / A2-s1dO - EN 13501-1

It is in compliance with the NF EN 12467 Standard (class 4 - category A).





MADE-TO-MEASURE MANUFACTURE

Because every project is unique, ATELIER SO GREEN is at your disposal to create it tailor-made to your requirements.

With long experience to our credit, along with finely honed technical skills, unrivalled proficiency in the manufacture of our «Made in France» products at our Touraine workshops, we manufacture our products to order only and therefore to your specifications.

It's your choice !

Formats proposed on our catalog is an illustration of our manufacturing capacity without being a limit.

So the **Image`In** range will meet the needs of all your projects, however specialised, under the best possible quality and service conditions. The Image`In range of planters and furniture provides an unlimited choice of shapes, sizes, colours, finishes, etc.



THE VIRTUAL RANGE

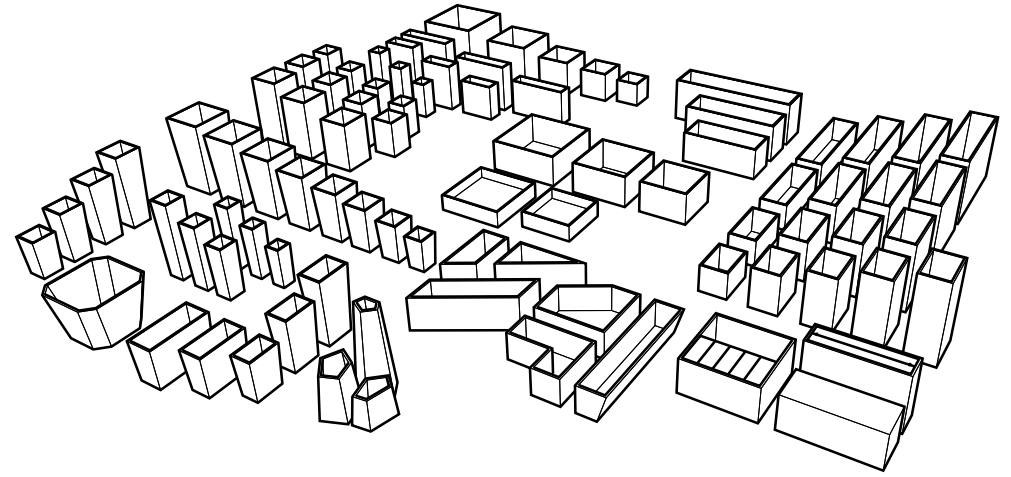



ICH - IMAGE'IN CARRÉ HAUT

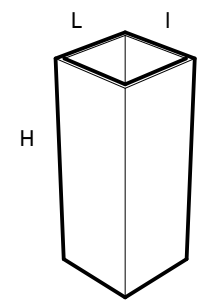

	L/I	H		L/I	H		L/I	H
ICH 30H80	30	80	ICH 40H80	40	80	ICH 50H80	50	80
ICH 30H100	30	100	ICH 40H100	40	100	ICH 50H100	50	100
ICH 30H120	30	120	ICH 40H120	40	120	ICH 50H120	50	120

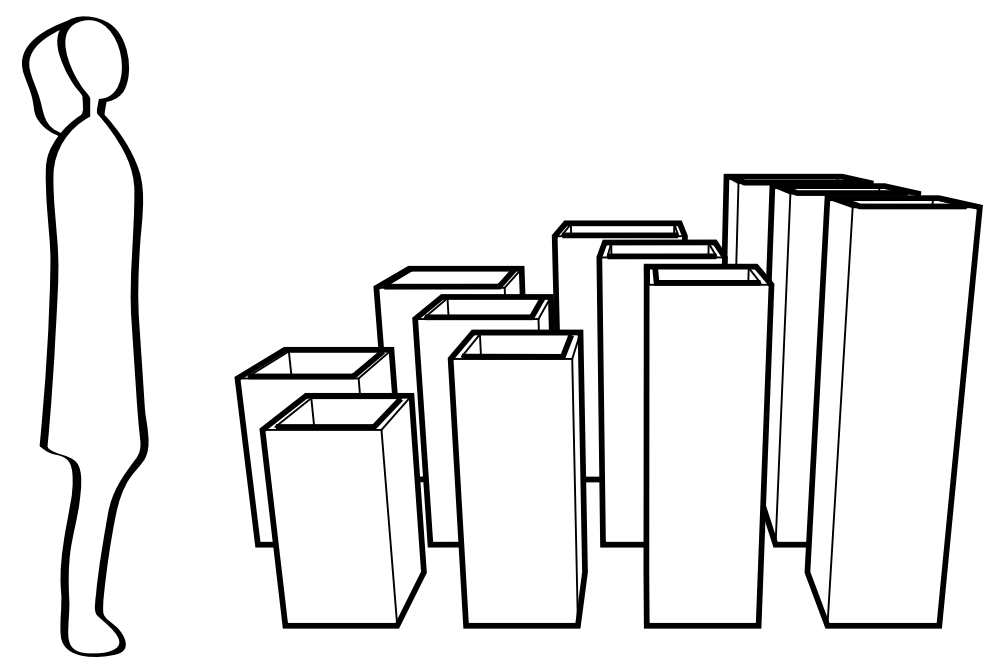

ICC - IMAGEIN CARRÉ CUBIQUE

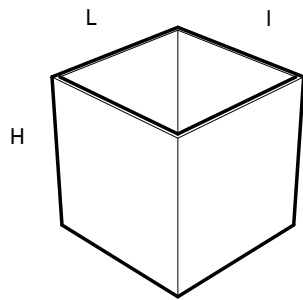

	L / I / H
ICC 40	40
ICC 50	50
ICC 60	60
ICC 75	75
ICC 90	90

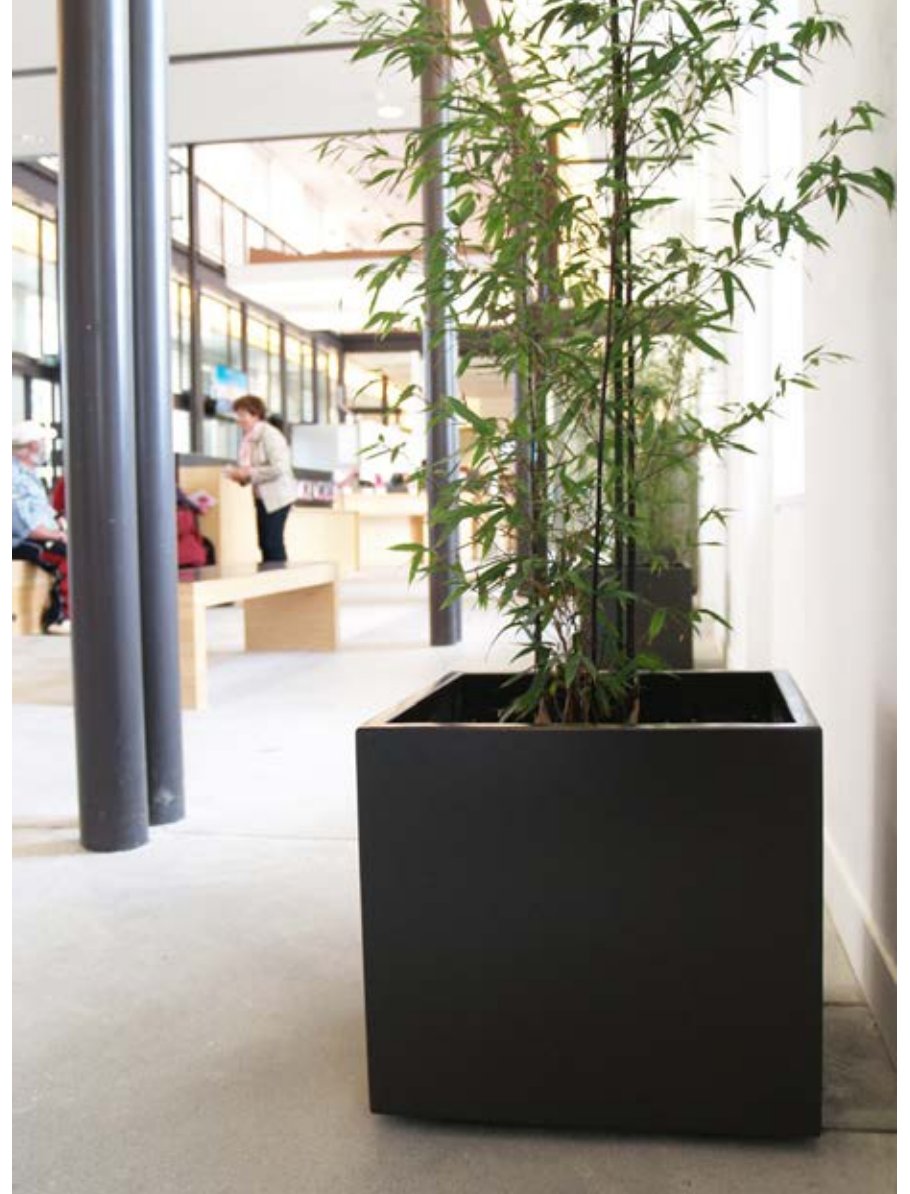
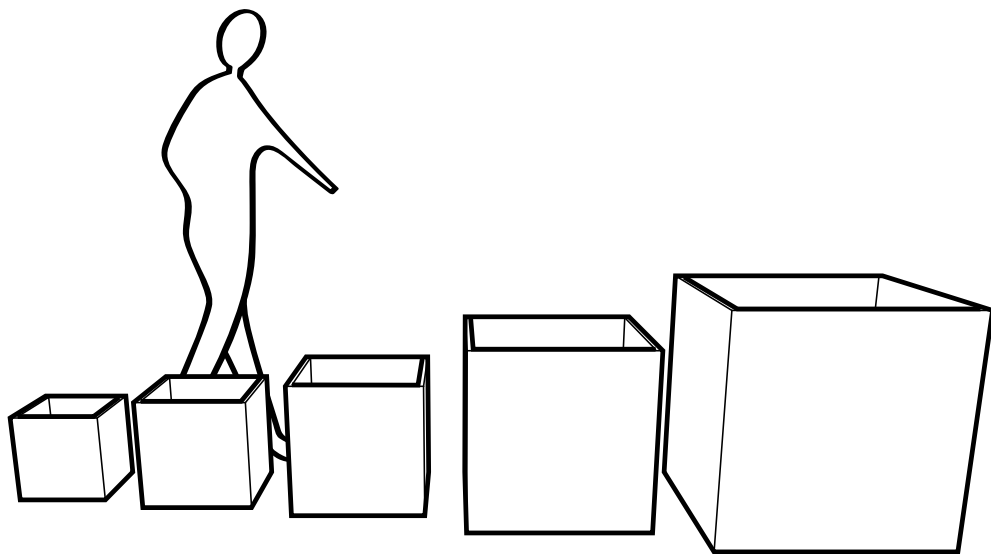

ICM - IMAGE'IN CARRÉ MOYEN

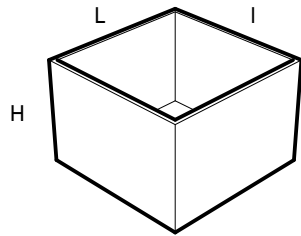

	L / I	H
ICM 75	75	50
ICM 90	90	50
ICM 110	110	50

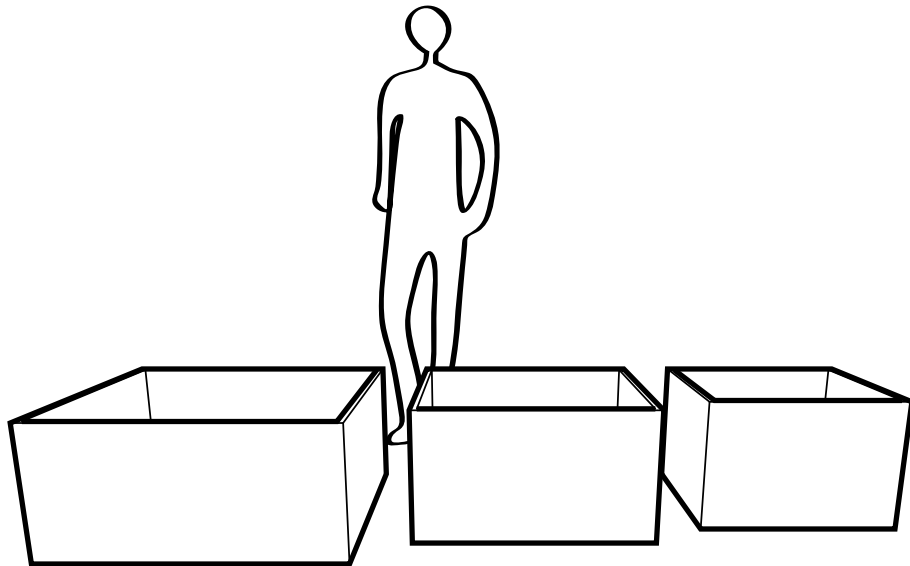



ICB - IMAGE'IN CARRÉ BAS

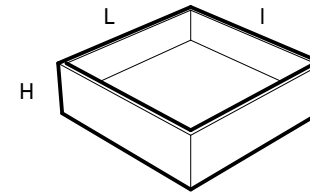

	L / I	H
ICB 80	80	20
ICB 100	100	20

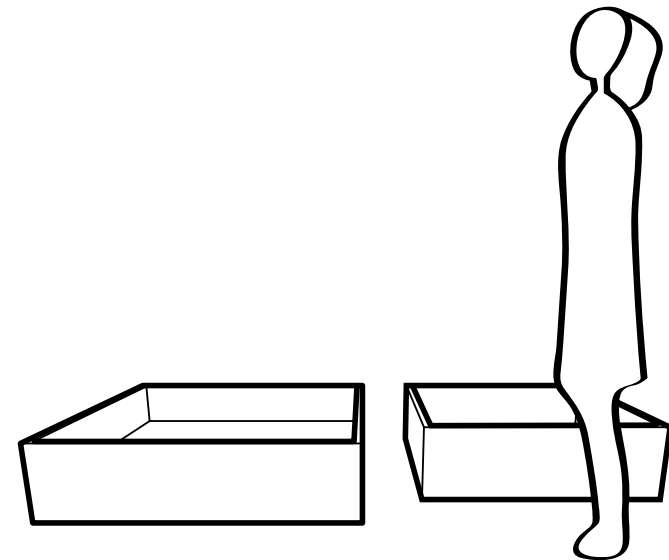



IRF - IMAGE'IN RECTANGLE FIN

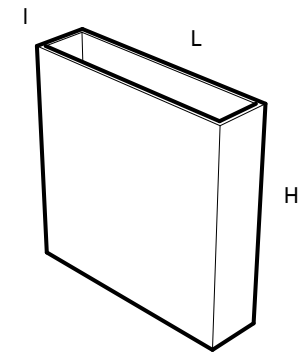

	L	I	H		L	I	H		L	I	H
IRF 25H60	25	25	60	IRF 25H80	25	25	80	IRF 25H100	25	25	100
IRF 60H60	60	25	60	IRF 60H80	60	25	80	IRF 60H100	60	25	100
IRF 100H60	100	25	60	IRF 100H80	100	25	80	IRF 100H100	100	25	100

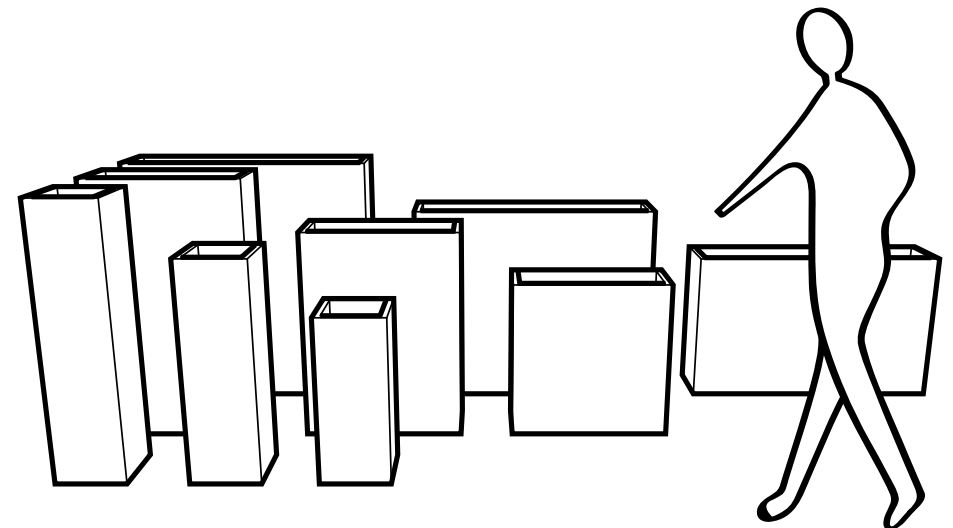

IRM - IMAGE'IN RECTANGLE MOYEN

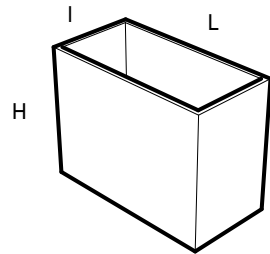

L	I		H		H		H		H
60	40	IRM 60H40	40	IRM 60H60	60	IRM 60H80	80	IRM 60H100	100
80	40	IRM 80H40	40	IRM 80H60	60	IRM 80H80	80	IRM 80H100	100
120	40	IRM 120H40	40	IRM 120H60	60	IRM 120H80	80	IRM 120H100	100
160	40	IRM 160H40	40	IRM 160H60	60	IRM 160H80	80		
60	40	IRM 60H120	120						

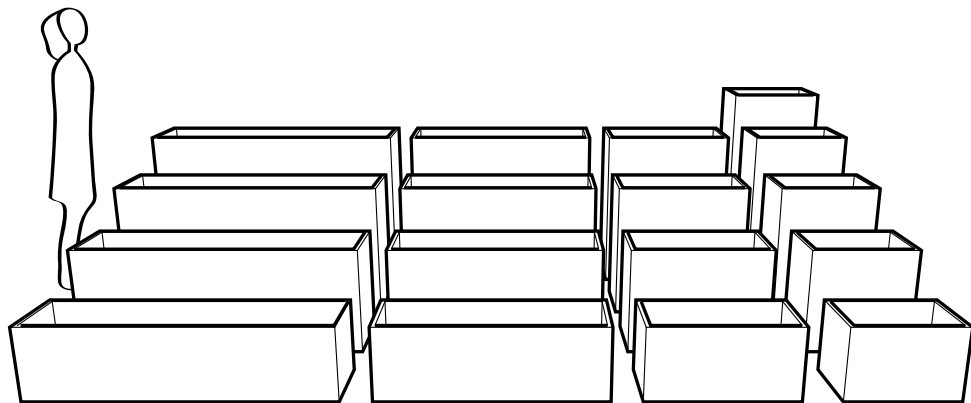



IRG - IMAGE'IN RECTANGLE GROS

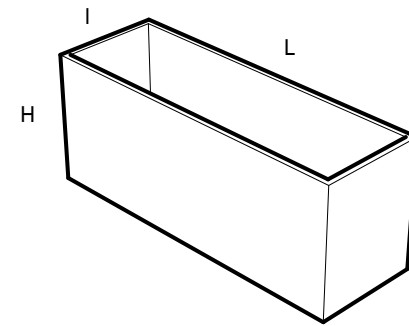

	L	I	H
IRG 12OH50	120	50	50
IRG 15OH55	150	50	55
IRG 18OH60	180	50	60

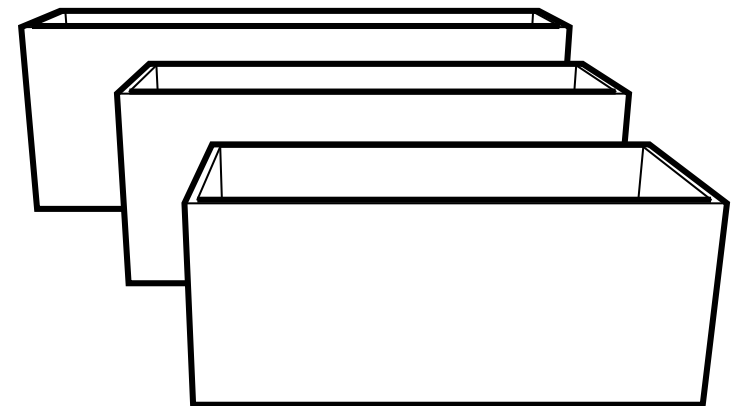

IPF - IMAGE'IN PYRAMIDE FINE

	B / b	L / l	H
IPF 20H60	20	23	60
IPF 20H80	20	24	80
IPF 20H100	20	25	100
IPF 25H80	25	29	80
IPF 25H100	25	30	100
IPF 25H120	25	31	120

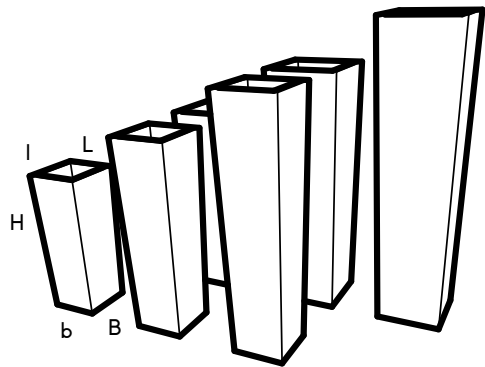

IPR - IMAGE'IN PYRAMIDE RECTANGLE

	B	b	L	l	H
IPR 40H100	40	25	50	35	100
IPR 40H80	40	25	48	33	80
IPR 40H60	40	25	46	31	60
IPR 70H60	64	29	70	35	60
IPR 90H60	84	34	90	40	60

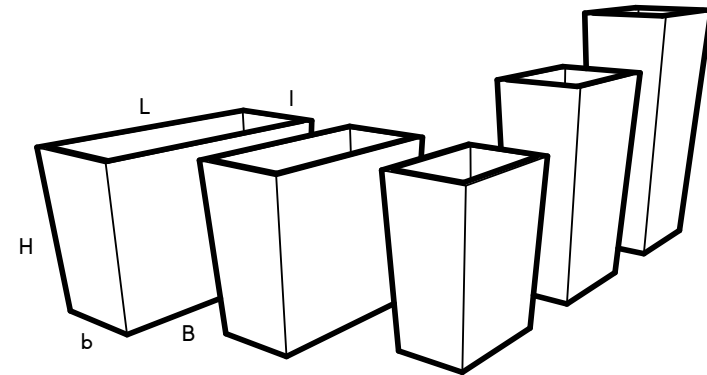

IPM - IMAGE'IN PYRAMIDE MOYENNE

	B / b	L / l	H
IPM 30H60	30	36	60
IPM 30H80	30	38	80
IPM 30H100	30	40	100
IPM 30H120	30	42	120

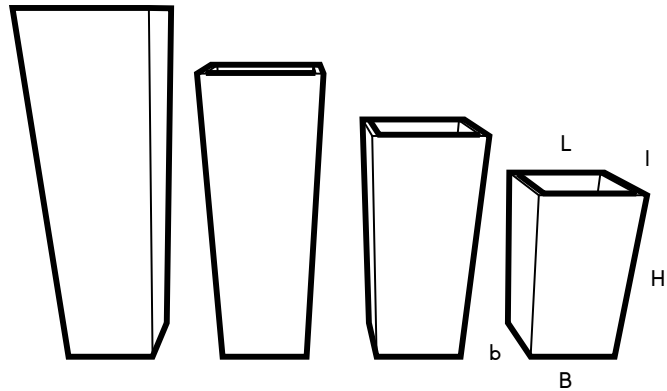

IPP - IMAGE'IN PYRAMIDE PROPORTIONNELLE

	B / b	L / l	H		B / b	L / l	H
IPP 30H50	25	30	50	IPP 50H90	41	50	90
IPP 35H60	29	35	60	IPP 55H100	45	55	100
IPP 40H70	33	40	70	IPP 60H110	49	60	110
IPP 45H80	37	45	80	IPP 65H120	53	65	120

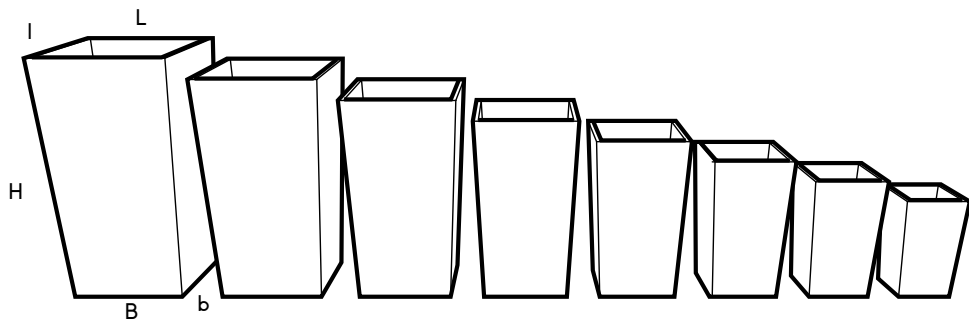

IMAGE'IN - THE SPECIALS

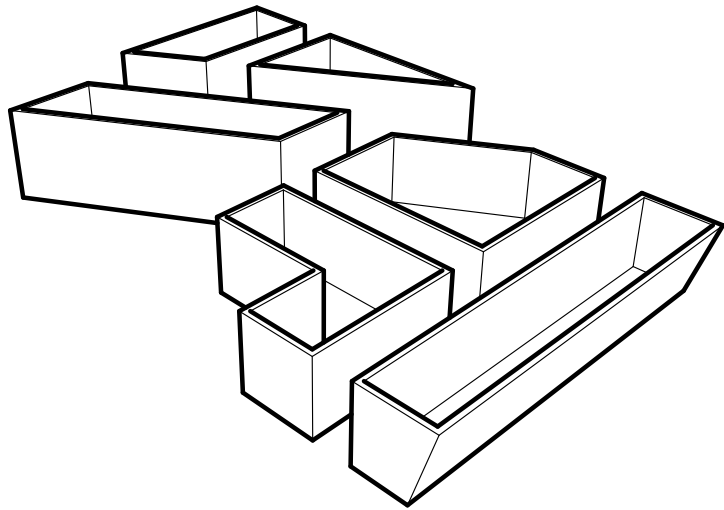

IMAGE'IN - THE SPECIALS

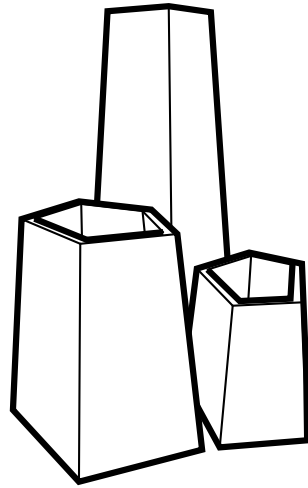

IMAGE'IN - CHESTS & SEATS

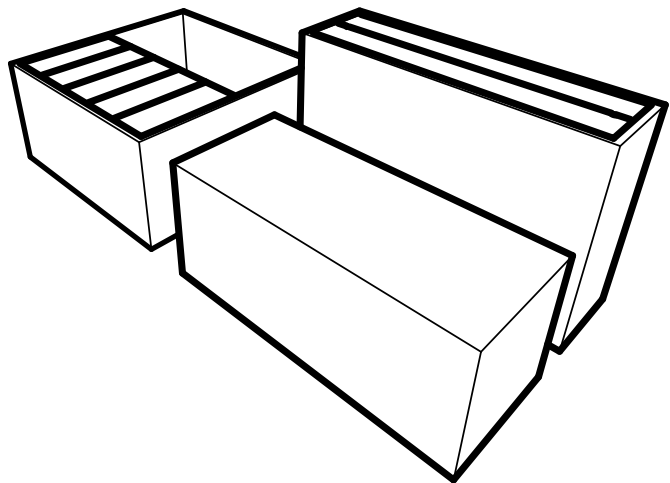

COLOURS & FINISHES

COLOURS

We provide all shades on the RAL standard colour chart.
Other shades possible on request, by colour matching your sample.

**Warning : The depiction of the colours on the screen or on paper is not always true to life.
It is better to consult a paper standardised colour chart.**

FINISHES

Choose your varnish in finish : Matt Satin, Gloss or Micronised (also called Sanded).

RAL 1000 Green Beige	RAL 1001 Beige	RAL 1002 Sand Yellow	RAL 1003 Signal Yellow	RAL 1004 Golden Yellow	RAL 1005 Honey Yellow	RAL 1006 Maize Yellow	RAL 1007 Doffdill Yellow	RAL 1011 Brown Beige	RAL 1012 Lemon Yellow	RAL 1013 Oyster White	RAL 1014 Ivory	RAL 1015 Light Ivory	RAL 1016 Sulfur Yellow
RAL 1017 Saffron Yellow	RAL 1018 Zinc Yellow	RAL 1019 Grey Beige	RAL 1020 Olive Yellow	RAL 1021 Cola Yellow	RAL 1023 Traffic yellow	RAL 1024 Ochre Yellow	RAL 1027 Curry	RAL 1028 Melon Yellow	RAL 1032 Broom Yellow	RAL 1033 Dahlia Yellow	RAL 1034 Pastel Yellow	RAL 1037 Sun Yellow	
RAL 2000 Yellow Orange	RAL 2001 Red Orange	RAL 2002 Vermilion	RAL 2003 Pastel Orange	RAL 2004 Pure Orange	RAL 2008 Bright Red Orange	RAL 2009 Traffic Orange	RAL 2010 Signal Orange	RAL 2011 Deep Orange	RAL 2012 Salmon Orange				
RAL 3000 Flame Red	RAL 3001 Signal Red	RAL 3002 Carmine Red	RAL 3003 Ruby red	RAL 3004 Purple Red	RAL 3005 Wine Red	RAL 3007 Black Red	RAL 3009 Oxyde Red	RAL 3011 Brown Red	RAL 3012 Beige Red	RAL 3013 Tomato Red	RAL 3014 Antique Pink	RAL 3015 Light Pink	RAL 3016 Coral Red
RAL 3017 Rose	RAL 3018 Strawberry Red	RAL 3020 Traffic Red	RAL 3022 Salmon Pink	RAL 3027 Raspberry Red	RAL 3028 Pure Red	RAL 3031 Orient Red							
RAL 4001 Red Lilac	RAL 4002 Red Violet	RAL 4003 Heather Violet	RAL 4004 Claret Violet	RAL 4005 Blue Lilac	RAL 4006 Traffic Purple	RAL 4007 Purple Violet	RAL 4008 Signal Violet	RAL 4009 Pastel Violet	RAL 4010 Telemagenta				
RAL 5000 Violet Blue	RAL 5001 Green Blue	RAL 5002 Ultramarine Blue	RAL 5003 Sapphire Blue	RAL 5004 Black Blue	RAL 5005 Signal Blue	RAL 5007 Brilliant Blue	RAL 5008 Grey Blue	RAL 5009 Azure Blue	RAL 5010 Gentian Blue	RAL 5011 Steel Blue	RAL 5012 Light Blue	RAL 5013 Cobalt Blue	RAL 5014 Pigeon Blue
RAL 5015 Sky Blue	RAL 5017 Traffic Blue	RAL 5018 Turquoise Blue	RAL 5019 Capri Blue	RAL 5020 Ocean Blue	RAL 5021 Water Blue	RAL 5022 Night Blue	RAL 5023 Distant Blue	RAL 5024 Pastel Blue					
RAL 6000 Patina Green	RAL 6001 Emerald Green	RAL 6002 Leaf Green	RAL 6003 Olive Green	RAL 6004 Blue Green	RAL 6005 Moss Green	RAL 6006 Grey Olive	RAL 6007 Bottle Green	RAL 6008 Brown Green	RAL 6009 Fir Green	RAL 6010 Grass Green	RAL 6011 Reseda Green	RAL 6012 Black Green	RAL 6013 Reed Green
RAL 6014 Yellow Olive	RAL 6015 Black Olive	RAL 6016 Turquoise Green	RAL 6017 May Green	RAL 6018 Yellow Green	RAL 6019 Pastel Green	RAL 6020 Chrome Green	RAL 6021 Pale Green	RAL 6022 Olive Drab	RAL 6024 Traffic Green	RAL 6025 Fern Green	RAL 6026 Opal Green	RAL 6027 Light Green	RAL 6028 Pine Green
RAL 6029 Mint Green	RAL 6032 Signal Green	RAL 6033 Mint Turquoise	RAL 6034 Pastel Turquoise	RAL 6037 Pearl Green									
RAL 7000 Squirrel Grey	RAL 7001 Silver Grey	RAL 7002 Olive Grey	RAL 7003 Moss Grey	RAL 7004 Signal Grey	RAL 7005 Mouse grey	RAL 7006 Beige Grey	RAL 7008 Khaki Grey	RAL 7009 Green Grey	RAL 7010 Tarpaulin Grey	RAL 7011 Iron Grey	RAL 7012 Basalt Grey	RAL 7013 Brown Grey	RAL 7015 Slate Grey
RAL 7016 Arihante Grey	RAL 7021 Black Grey	RAL 7022 Umbrina Grey	RAL 7023 Concrete Grey	RAL 7024 Graphite Grey	RAL 7026 Granite Grey	RAL 7030 Stone Grey	RAL 7031 Blue Grey	RAL 7032 Pebble Grey	RAL 7033 Cement Grey	RAL 7034 Yellow Grey	RAL 7035 Light Grey	RAL 7036 Platinum Grey	RAL 7037 Dusty Grey
RAL 7038 Agate Grey	RAL 7039 Quartz Grey	RAL 7040 Window Grey	RAL 7042 Traffic Grey A	RAL 7043 Traffic Grey B	RAL 7044 Silk Grey	RAL 7045 Telegrey 1	RAL 7046 Telegrey 2	RAL 7047 Telegrey 4					
RAL 8000 Green Brown	RAL 8001 Ochre Brown	RAL 8002 Signal Brown	RAL 8003 Clay Brown	RAL 8004 Copper Brown	RAL 8007 Fawn Brown	RAL 8008 Olive brown	RAL 8011 Nut Brown	RAL 8012 Red Brown	RAL 8014 Sepia Brown	RAL 8015 Chestnut Brown	RAL 8016 Halogreny Brown	RAL 8017 Chocolate Brown	RAL 8019 Grey Brown
RAL 8022 Black Brown	RAL 8023 Orange Brown	RAL 8024 Beige Brown	RAL 8025 Pale Brown	RAL 8028 Terra Brown									
RAL 9001 Cream	RAL 9002 Grey White	RAL 9003 Signal White	RAL 9004 Signal Black	RAL 9005 Jet Black	RAL 9006 White Aluminium	RAL 9007 Grey Aluminium	RAL 9010 Pure White	RAL 9011 Graphite Black	RAL 9016 Traffic White	RAL 9017 Traffic Black	RAL 9018 Papyrus White		

Option - Zinc Patina IOP-PZC

Hand-finished shine imitating the appearance of zinc. With matt finish.

These patina being the result of the applicator's labour, they will vary endlessly and it will never be possible to reproduce them exactly. The photos displayed on our sites and in our catalogues are just a rough guide.

Option - Rust look IOP-RUST

Rust look finish (type CORTEN brand); paint containing iron oxide particles; with matt finish.

These finishes being the result of the applicator's labour, they will vary endlessly and it will never be possible to reproduce them exactly. The photos displayed on our sites and in our catalogues are just a rough guide.

Possible alternative: «Marron Métallisé» IOP-MM or without additional cost : «Marron Oxyde Urbain» micronised varnish.



OPTIONS

PERFOS

Fittings for putting in automatic watering and / or lighting systems.
Simply on request, we can adapt the containers to suit your requirements : perforations, cut-outs, waterproof risers, etc.

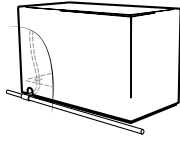

Horticultural System

IOP - SH

PSE Drainage system offering a 5L/m² reservoir - 40mm thick - 25kg/m³ density

IOP - SH60

PEHD Drainage system offering a 23L/m² reservoir (when full of agregats) - 60mm thick

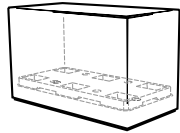

Water Level Indicator

IOP - INE

For pots used indoors which have a watertight base. The float indicates the water level at the bottom of the container. It allows the monitoring of watering.

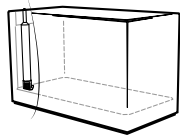

Installation on Casters for Handling

IOP - RL

Concealed under the container, the casters are not visible.
They allow the plant container to be moved from time to time.

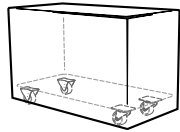

Installation on Adjustable Plot

IOP - PLOT

For a well-balanced installation, with a uniformly distributed load. Allows water to flow underneath the container and also allows adjustments in the alignment of linear arrangements of containers. Reserved for >40cm wide containers.

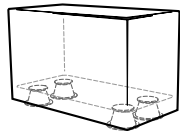

Installation on Adjustable Feet

IOP - PR

For installation on sloping ground or to replace IOP-PLOT for <40 cm wide containers.

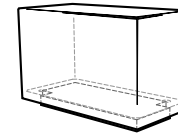

Installation on PSX panel

IOP - PSX

Polystyrene weight distribution buffer.
Avoids perforation if installing directly on waterproofing.

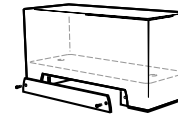

Handling by Forklift

IOP - MTP

Removable trap door concealing an access underneath the container for handling by forklift. Ideal for moving large containers from time to time.

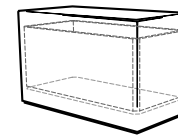

Wall insulation (PSX)

IOP - ISOL

Fibre-cement already has a low thermal exchange coefficient.
In areas with extremes of climate, wall insulation can be added.

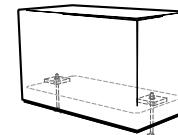

Hole and crosspiece for secure fixing

IOP - TES

Hole and crosspiece for lateral fixing

IOP - TEL

For the fixing of containers to each other or to a wall.

Warning : even with secure fixing, our products are decorative furniture.
They can't be considered as constitutive elements of buildings.

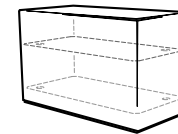

Raised base

IOP - FR

Allows a reduction in the volume and weight of the soil when plants do not require the whole capacity.

Reduction of useful height

IOP-PSE

Useful height reduced by an expanded polystyrene filling for planters installed on casters.
feet pads... requiring a bottom on a low level.

WATER MANAGEMENT

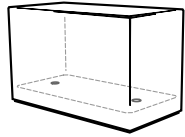

Draining base

Perforated base to drain off excess water underneath the container. Allows good drainage of rainwater and after watering, and also a good ventilation of the root ball. Ideal balance for pots used outdoors.

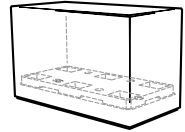

Water reservoir with Horticultural system

Allows the creation of a reservoir in the drainage section free from the risk of frost. Overflow drainage underneath the container or on one side via a weep hole.

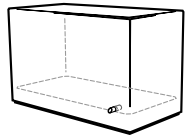

Drainage via Weep hole

Watertight base with overflow drainage via a weep hole on one side of the container, with or without water reservoir.

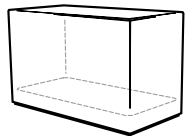

Watertight base

To avoid any discharge of dirty water when used indoors. Can be completed by a Water Level Indicator to control watering.

IMPLEMENTATION

Place a **geotextile pad at the bottom of the interior**. It is possible to fit the latter up the sides to allow moisture to migrate effectively. To ensure efficient and constant drainage, **build a drainage system into the bottom of the container** (5 to 15 cm of clay pellets, for example). **Place another layer of geotextile on top of the drainage system** to separate it from the planting substrate and the roots.

The **type of substrate depends on your plants**. Avoid heavy soil and / or which have a high propensity to compact. It might be a simple compost or a mixture of compost + garden soil. It can be lightened if necessary. **Ask your landscape gardener or your nursery for advice.**

It is possible to add a surface mulch. A few cm of clay pellets or bark will reduce evaporation and restrict the growth of weeds.

Download the complet installation instruction on www.ateliersogreen.com/documentation-imagein/?lang=en

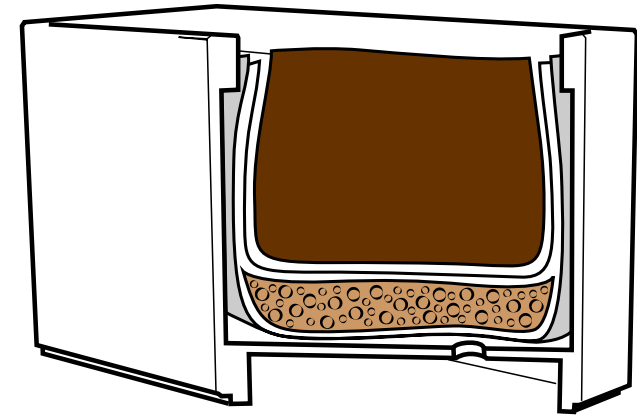

Horticultural System

No more need for a clay pellet drainage system. The horticultural polystyrene sheet ensures an efficient and constant drainage, combined with a 5L/m² reservoir (or more depending of the selected option). Ideal to ensure a water retention without harming the good ventilation of the root ball.

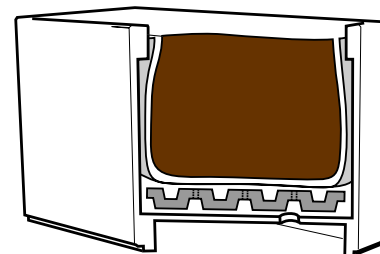



Edition

The ImageIn catalogue is edited by the company: Création Jean-Claude Joly SARL - SIRET 338 302 599 00042 RCS Tours.

Although it has been checked with great care, this catalogue may contain errors. The photos, images and information that compose it are indicative and can not be retained as object of possible complaints.

Photos credits

Création Jean Claude Joly, Jardins de Gally - Immochan, Bruno Oizan Chapon Paysagiste, De Københavnske Ejendomsselskaber, YPID - Yolande Pauwels Interior design, Les Vignes d'Alexandre, Cos Design, Nathalie Papait, Hôtel Atrium Surenes, Signes Extérieurs, Maudit Salaud - Charvin Paysagiste, Atelier Roberta, Nathalie Herchi, Abbaye de Fontevraud, Hugo Allard, Serrault Jardins, W.A.Y.S. - ALTAIS, SF Concept, Virtual Expo, Quille, Jardin Passion, Néolight, Technivert, Brasserie Basile, L'Imprimerie Hôtel, Brasserie Léopold, Abbaye d'Argenteuil, Thom Europhane, Atelier d'Architecture du paysage ...

Photos will be removed on request : info@cj.fr

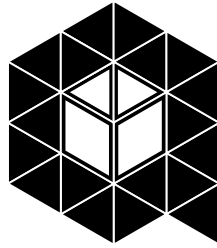

ATELIER
SO GREEN

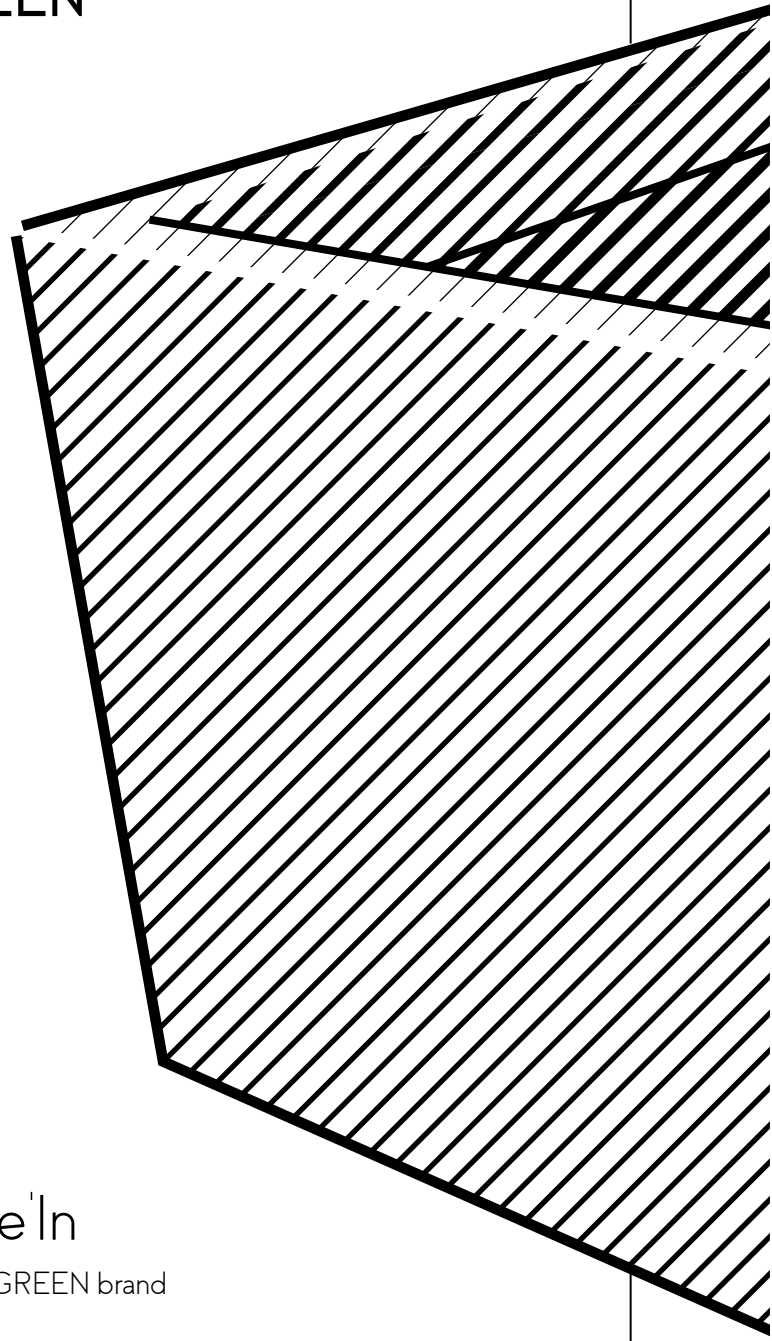

Image'In

an ATELIER SO GREEN brand

www.ateliersogreen.com

contact@ateliersogreen.com

T - 33 (0)2 47 65 13 62

9. rue Allaire - ZA la Canterie
37800 Ste Maure de Touraine
FRANCE